

 **User Manual**

ANYCUBIC PHOTON M3 MAX

Dear customer,

Thank you for choosing **ANYCUBIC** products.

Maybe you are familiar with 3D printing technology or have purchased **ANYCUBIC** printers before, we still highly recommend that you read this manual carefully. The installation techniques and precautions in this manual can help you avoid any unnecessary damage or frustration.

Please visit <https://www.anycubic.com/pages/contact-us> to contact us if you have any question. You can also gain more information such as software, videos, models from the website.



ANYCUBIC support center

Team **ANYCUBIC**

Copyrighted by "Shenzhen Anycubic Technology Co., Ltd ", all rights reserved.

Safety Instructions

Always follow the safety instructions during assembly and usage, to avoid unnecessary damage to the 3D printer or individual injury



Please contact our customer service first if you have any issue after receiving the products.



Be cautious when using the scraper. Never direct the scraper towards your hands.



In case of emergency, please immediately cut off the power of **ANYCUBIC** 3D printer and contact the technical support.



ANYCUBIC 3D printer includes moving parts that can cause injury.



It is recommended to use protection glasses when sanding the printed models to avoid eye contact with small particles.



Keep the **ANYCUBIC** 3D printer and its accessories out of the reach of children.



Vapors or fumes may be irritating at operating temperature. Always use the **ANYCUBIC** 3D printer in an open and well ventilated area.



ANYCUBIC 3D printer must not be exposed to water or rain.



Operate **ANYCUBIC** 3D printer with a temperature of 8°C-40°C and a humidity of 20%-50%. For optimal performance, do not exceed this range. Also, avoid direct sunlight exposure.



Do not disassemble **ANYCUBIC** 3D printer, please contact technical support if you have any question.

Contents

1. Technical Specification	5
2. Packing List	7
3. Product Overview	8
4. Menu Directory.....	10
5. Assembly and Leveling Instructions	13
6. Auto-feed	18
7. First Print Instructions	22
8. Slicing Software Overview	24
9. FAQ and Machine Maintenance	25

Technical Specification

Printing

System	Anycubic Photon M3 Max
Operation	4.3-inch Color TFT Screen
Software	Anycubic Photon Workshop
Connectivity	USB memory stick

Specifications

Technique	LCD Shadow Masking
Light source	UV-LED (wavelength 405nm)
XY Resolution	46 μ m 6480*3600 (7K)
Z axis Accuracy	0.01 mm
Suggested Layer Thickness	0.01 ~ 0.1mm
Rated power	120 W

Physical Dimensions

Dimension	400 mm (L) *408 mm (W) *596 mm (H)
Build volume	298 mm (L) *164 mm (W) *300 mm (H)
Materials	405 nm UV-resin
Net weight	~21 kg

Technical Specification

Recommended Printing Parameters











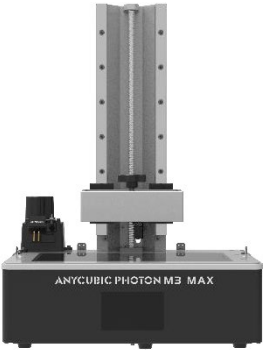

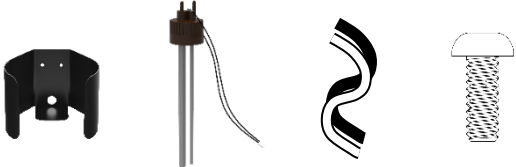
Layer Thickness	0.05 mm
Normal Exposure Time	3 s
Off Time	2 s
Bottom Exposure Time	30 s
Bottom Layers	6
Z Lift Distance	10 mm
Z Lift Speed	4 mm/s
Z Retract Speed	4 mm/s
Anti-alias	1

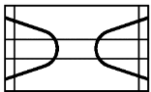
Note:

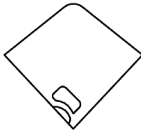
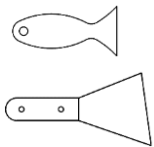
The recommended printing parameters above is for reference only, which is more suitable for Anycubic resin.

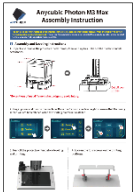
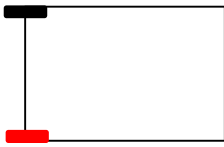

Packing List

			
<p>Anycubic Photon M3 Max</p>		<p>Cover unit (screws: M3*6mm 8PCS)</p>	
			
<p>Auto-feed unit (screws: M3*6mm 2PCS)</p>		<p>Print platform 1PC</p>	<p>Resin vat 1PC</p>
			
<p>Mask 1PC</p>	<p>Gloves 3Pairs</p>	<p>Funnel 5PCS</p>	<p>Scrapers 2PCS</p>
			
<p>USB memory 1PC</p>	<p>Assembly Instruction 1PC</p>	<p>Screen protector kit</p>	<p>Leveling paper 1PC</p>
			
<p>Power adaptor 1PC</p>		<p>Tool kit</p>	

Product Overview

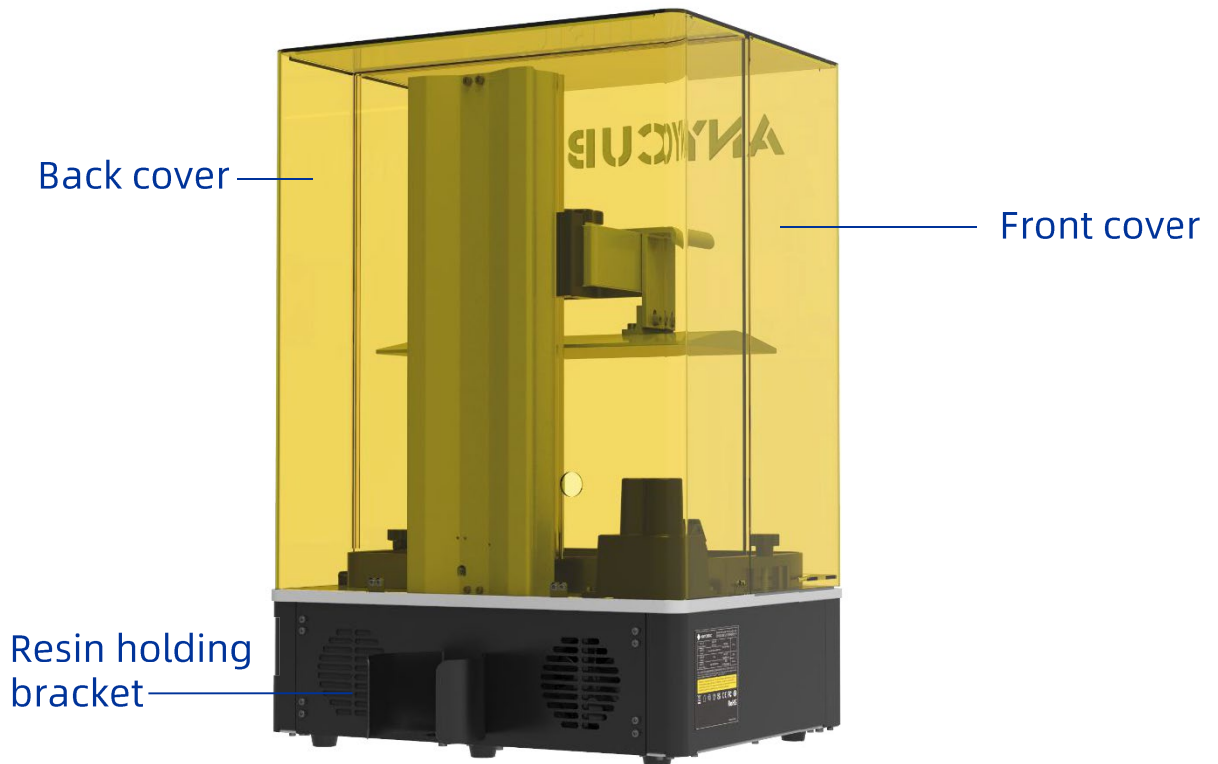
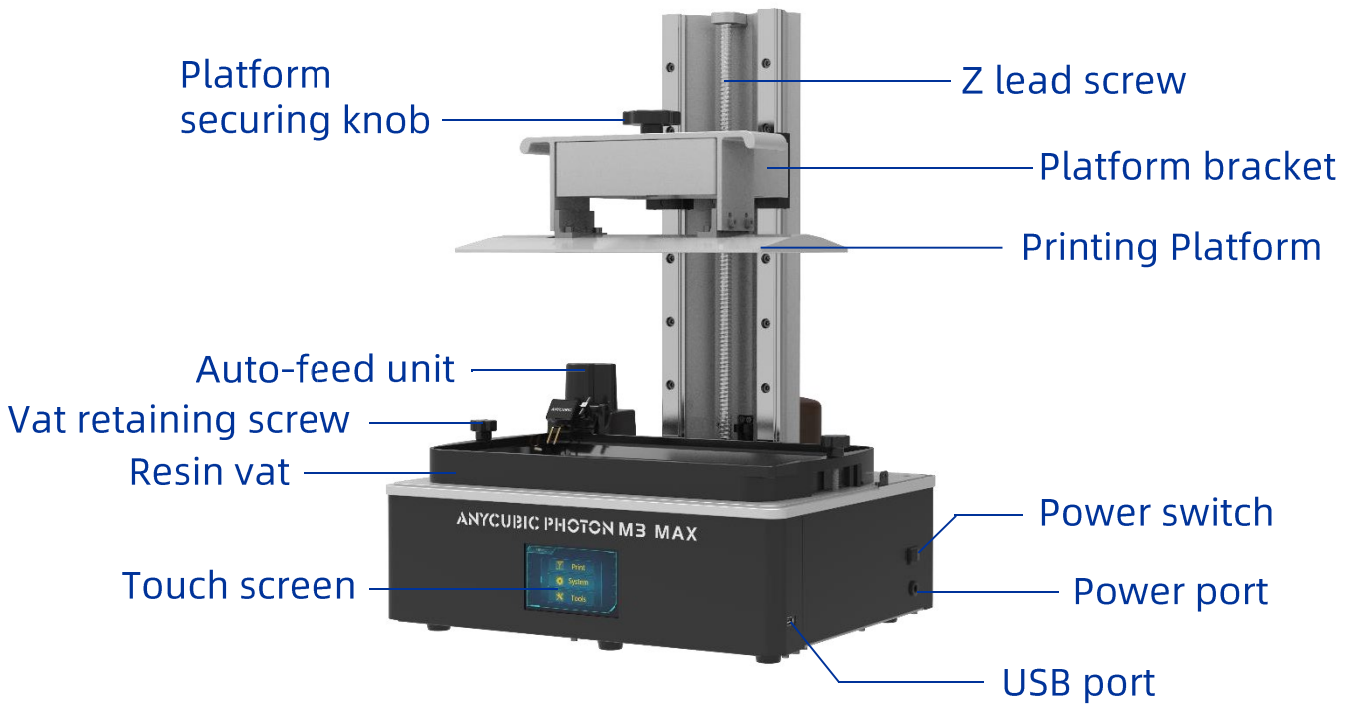

Product Overview

Auto-feed unit

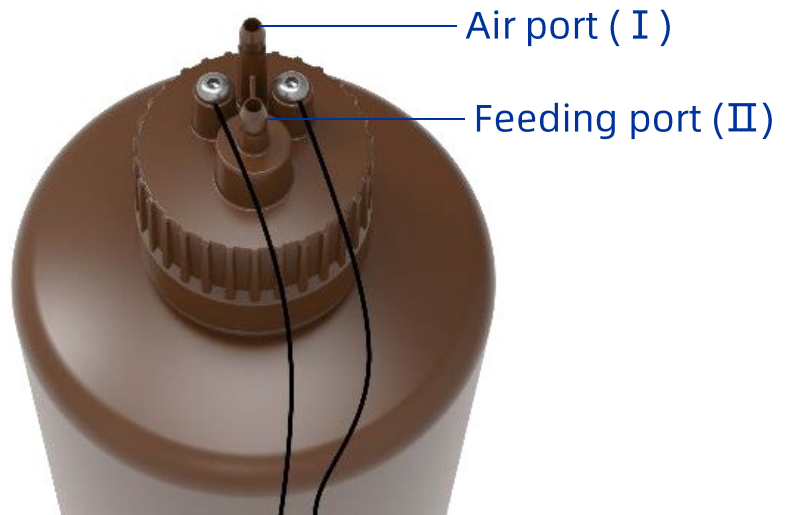
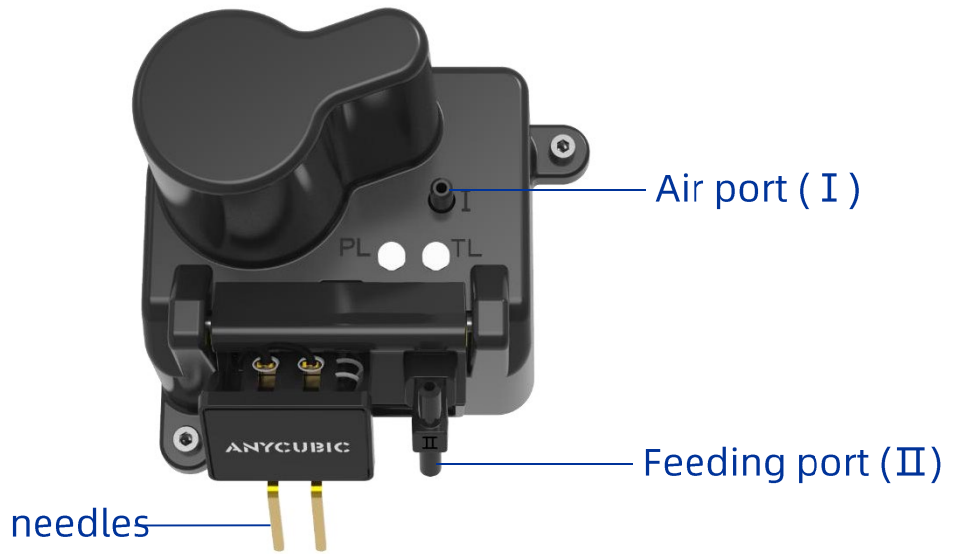

Menu Directory

Home menu

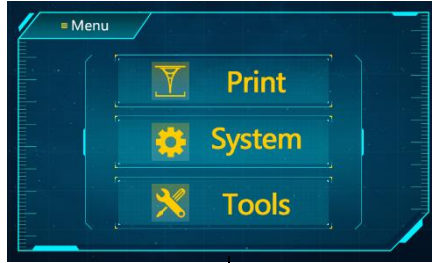

Print

System

Tools

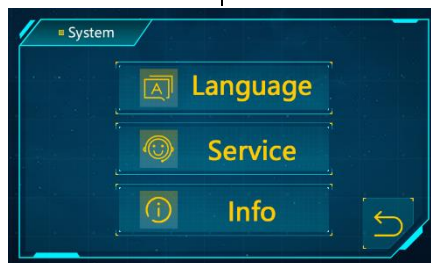

Home menu

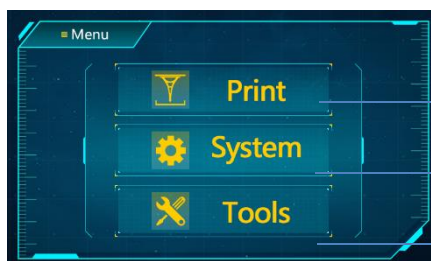

Enter the Print Menu

Enter the System Menu

Enter the Tools Menu

Menu Directory

Print

File List:



Switch USB file list to local file list

Page up

Page down

Return to the Home Menu

Click Files



Save to local file list

Delete the current file

Click to start printing

Return to the Print Menu

System

Language: Change language(English/Chinese)

Service:



Official website

Return to the System Menu

Information:



Product system

System version

Product ID

Return to the System Menu

Menu Directory

Tools

Move Z:



Move the Z axis downwards

Move the Z axis upwards

Stop moving the Z axis

Move Z by 0.1mm/1mm/10mm

Return to Zero

Return to the Tools Menu

Reset the zero point

The 'Move Z' menu features a dark blue background with yellow text and icons. At the top, it says 'Move Z'. Below this are three buttons for movement increments: '0.1mm', '1mm', and '10mm'. The next row contains three directional buttons: an upward arrow, a downward arrow, and a house icon representing 'Return to Zero'. The final row has three buttons: a stop icon, a 'Z=0' button, and a left-pointing arrow icon for returning to the Tools Menu.

Detection:

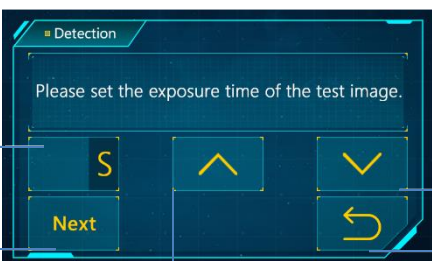

Click to set the test time

Test LED and LCD for the preset time

Increase the test time

Reduce the test time

Return to the Tools Menu

The 'Detection' menu has a dark blue background with yellow text and icons. The title is 'Detection'. Below the title is the instruction 'Please set the exposure time of the test image.' There are four main buttons: a button with an 'S' icon, a 'Next' button, an upward arrow, and a downward arrow. A left-pointing arrow icon is also present at the bottom right.

Exposure:



Click to set the exposure time

Expose for the preset time

Select one of the images to expose

Return to the Tools Menu

The 'Exposure' menu has a dark blue background with yellow text and icons. The title is 'Exposure'. Below the title is the instruction 'Please set the exposure time.' There are six main buttons: a button with an 'S' icon, a 'Next' button, two buttons with image icons (one showing a single image, the other showing multiple images), and a left-pointing arrow icon.

Gear icon: Enter to set feeding speed

Tap icon: Enable/disable the auto-feed function

Horn icon: Turn on/off the screen sound

Assembly and Leveling Instructions

1. Unpack and remove the protective metal frame, foam and zip ties. Take out the machine and its accessories.

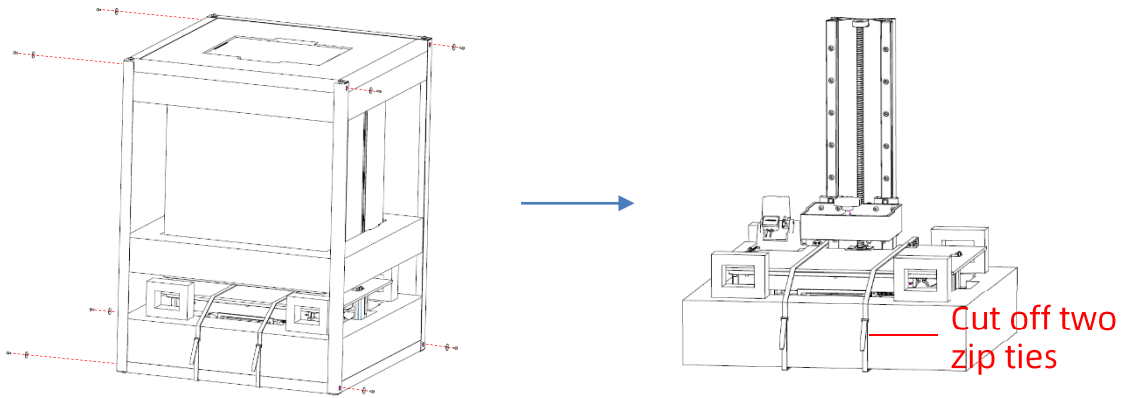

*Be cautious of metal frame's sharp edges to avoid injury.

2. Plug in power and turn on the machine. Raise Z axis to a certain height that the curing screen will not be scratched when the printing platform is installed.

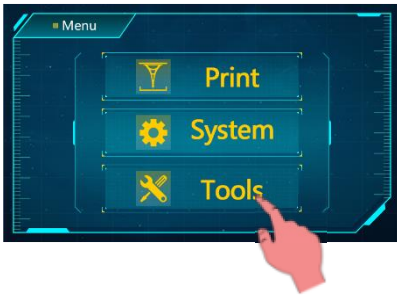

3. Tear off the protective film before leveling and printing.

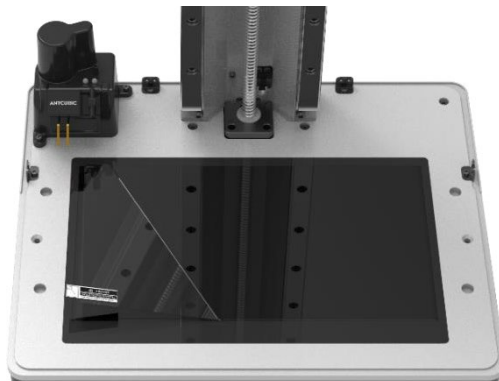

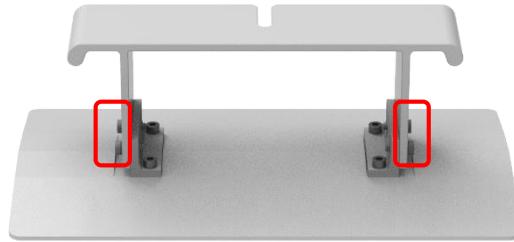

Assembly and Leveling Instructions

4. Loosen the four screws on the printing platform.

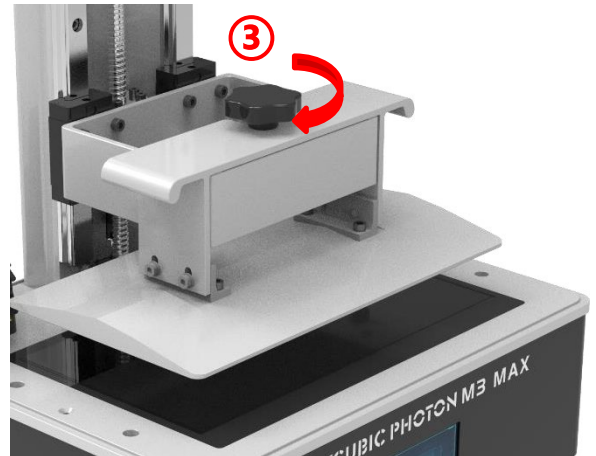
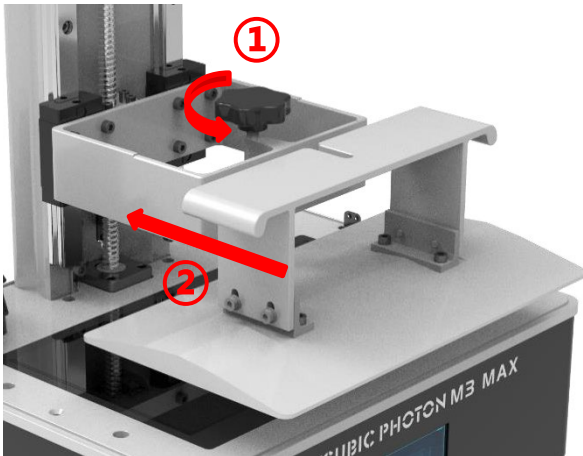

5. Install the printing platform.



6. Place a leveling paper on the curing screen. Then click “  ” on touch screen. Wait for the Z axis to descend and stop automatically.

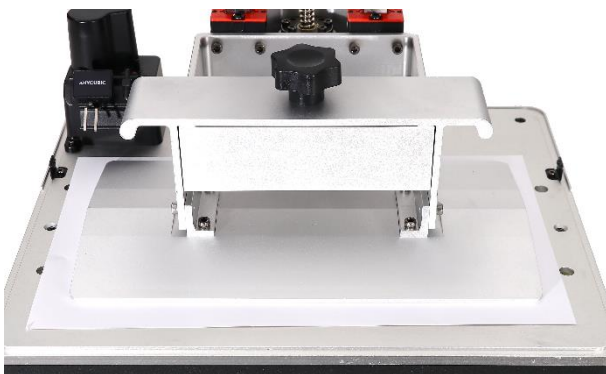

Assembly and Leveling Instructions

7. Use your fingers to press the platform gently, to let it fit evenly on the curing screen. Then, tighten the four screws on the platform.

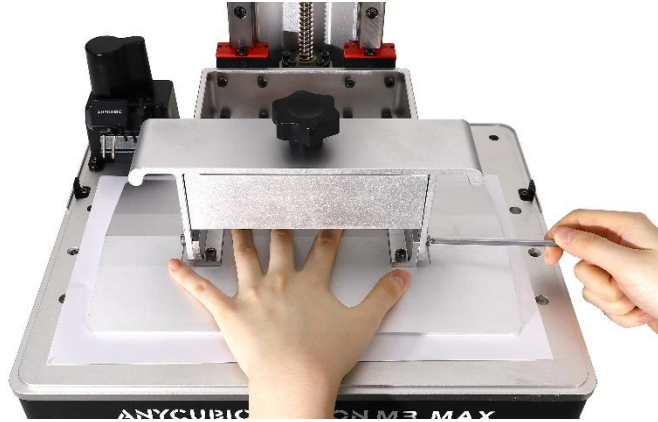

8. Click "Z=0" to save the zero position, and then click "Enter" on the pop-up window. Till now, the leveling process is finished. Click "Enter" again and take out the leveling paper.

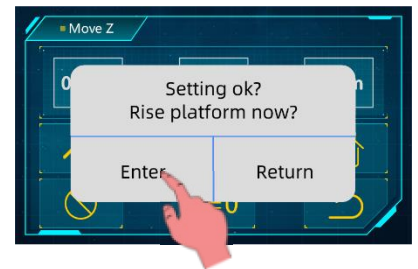
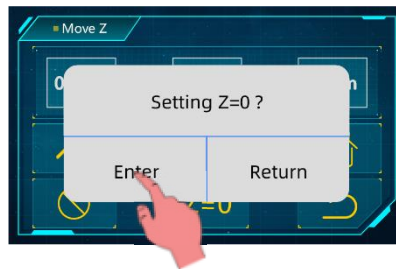

9. Detection: Raise printing platform until the curing screen can be observed completely. Return to Tools menu and click "Detection", set the test time and then click "Next". The curing screen should display a complete image as shown below.

Click here to set the test time

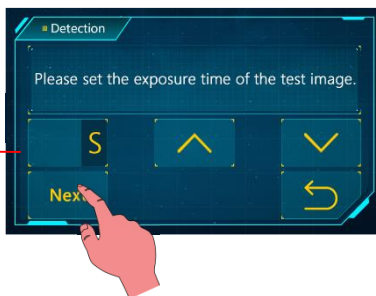

Assembly and Leveling Instructions

10. Install resin vat with both needles being set in it.

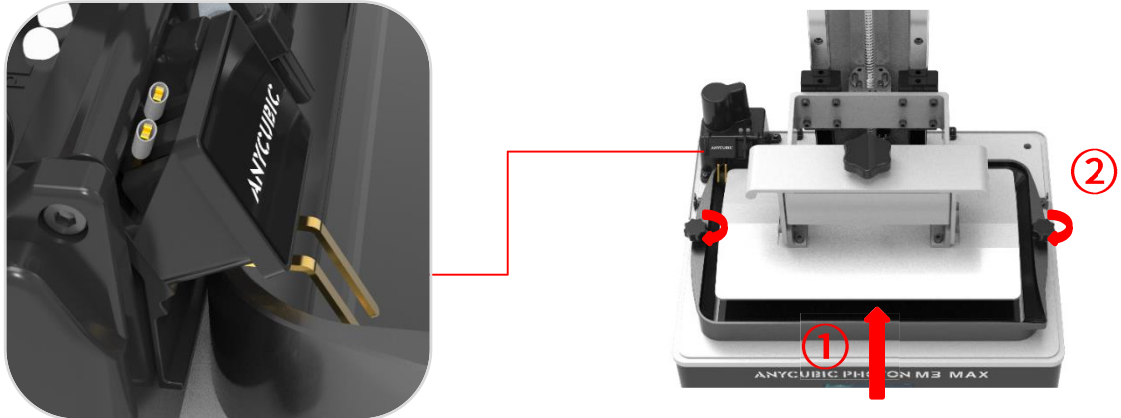

11. Install the back cover, Then, if the auto-feed unit is not needed at the moment, the installation is finished.

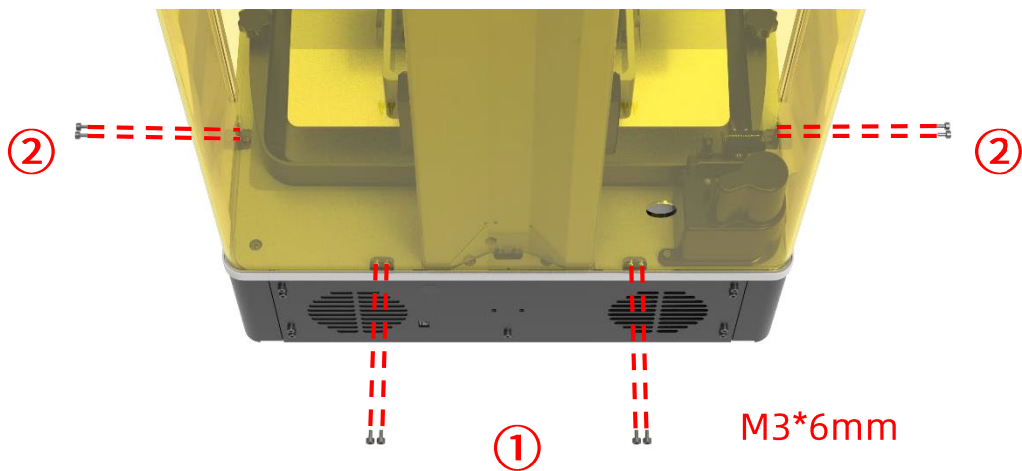

12. Turn the machine back and install resin-holding bracket first.

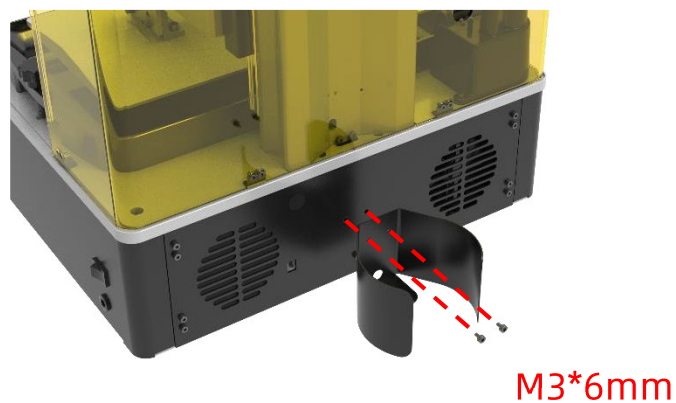

Assembly and Leveling Instructions

13. Put the cap part on **Anycubic 1kg resin bottle** and tighten it. Place resin bottle on the bracket and connect the cap part wire to machine.

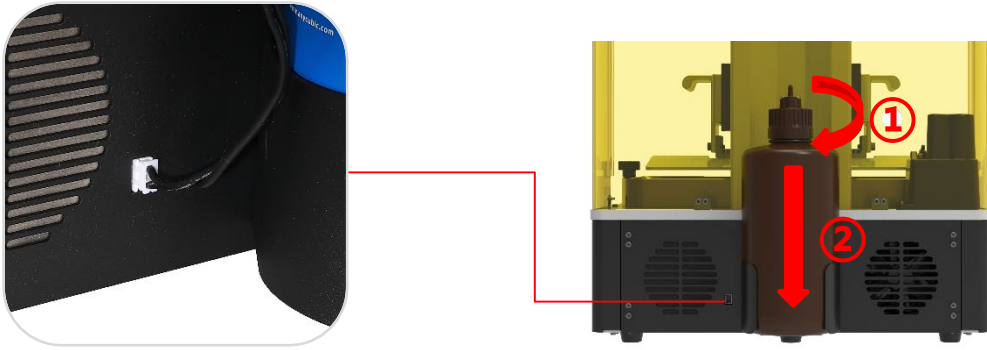

TIPS: When you change resin, it is recommended to tighten the cap through rotating bottle to avoid blockage caused by twisting pipes.

14. Pass two pipes through the limit hole on the back cover. **Connect ports II with feeding pipe (black) and connect ports I with air pipe (transparent)** . Please completely follow this way of connection to avoid the damage of auto-feed unit.

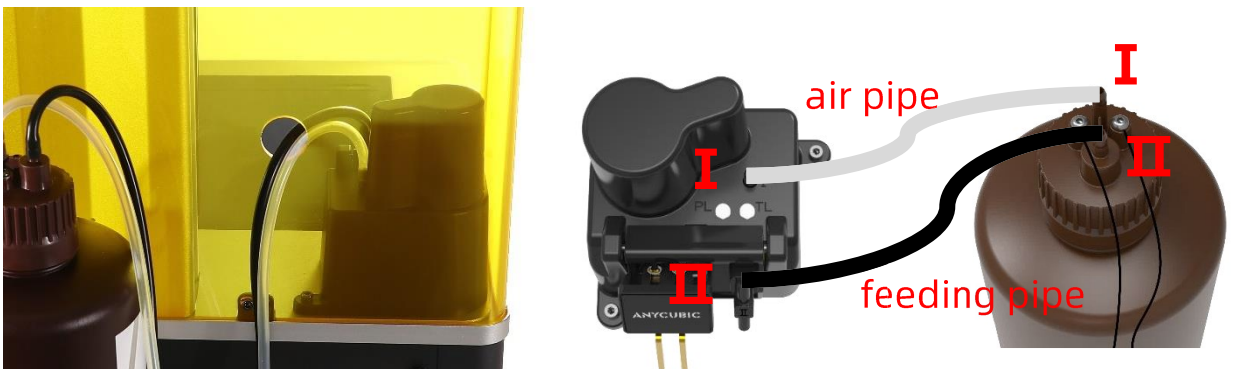

Auto-feed

1. Instructions

Ensure the auto-feed unit has been installed and the resin in bottle is enough to print. Click “Tools” → “” to enable the function. It will feed in automatically if resin in the vat is sufficient during printing.



Click to enable auto-feed function

- Auto-feed only works when machine is printing.
- The unit feeds every five minutes normally.
- Red light indicates that resin is not detected by needles. When needles detects resin, the light goes off.
- Green light indicates that the unit has been powered.

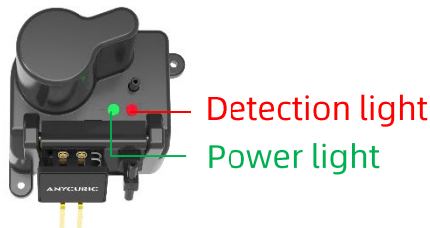

If the insufficiency of the resin in holder is detected when it is printing, the machine will beep to warn and disable auto-feed function. Please add or change resin first and enable the function in Set up if necessary.

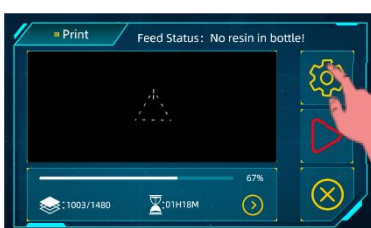

Click to enable auto-feed function

Auto-feed

Notice:

1. If you use non-Anycubic resin, it is suggested to check whether red light goes out normally when resin reaches both needles before printing. If not, the resin cannot be automatically fed.
2. To save resin, pour the remaining resin that is out of the reach of pipes to resin vat.
3. **DO NOT vigorously shake or turn over the resin bottle when cap part is installed. If the inside of cap is stained by resin, please immediately clean it to avoid malfunction or damage of auto-feed unit.**

2. Troubleshooting

Issues	Troubleshooting		Solution
Do not feed in during printing	Red light is off	The resin in vat reaches both needles	Wait until the resin is insufficient.
		The resin in vat does not reach both needles	The power light(green) is off, reconnect the wire under detection unit.
			Two needles touch each other. Please contact the tech support.
			Resin abnormally gets into the air pipe to cause malfunction of the unit. A replacement is needed.

Auto-feed

Issues	Troubleshooting		Solution
Do not feed in during printing	Red light is on	Waiting status	It feeds every five minutes normally. Wait for the next feeding.
		Feeding status	The wrong connection of air pipe and feeding pipe cause malfunction of auto-feed unit. A replacement is needed.
The machine shows resin in bottle is insufficient and disable auto-feed function	Resin in bottle is insufficient		Add resin to bottle
	Resin in bottle is sufficient but machine shows feed status as "No resin in bottle!"	The two screws on the cap is loosened	Tighten the screws
		The wire connecting cap and machine is disconnected	Connect the wire to machine
Nothing wrong with screws and wire	The resin cannot be used for auto-feed		

Auto-feed

Issues	Troubleshooting	Solution
Consistent feeding cause overflow of resin	Red light does not go off when resin reaches both needles	The resin cannot be used for auto-feed unit
	The lowest points of needles rise	Check whether you completely follow the assembly instructions
		Two needles are distorted. Please contact the tech support.

***Please contact the tech support if the troubleshooting above cannot solve your problem.**

First Print Instructions

1. Print

*Please check FEP film carefully before and after every printing. If the FEP film is broken, replace it immediately to avoid further damage to machine.

Wear masks and gloves (to avoid direct skin contact with resin), and slowly pour the resin into the vat. The resin cannot exceed the vat's maximum scale.

Then, put on front cover. Insert the USB memory into the USB port, print the test file in it. (The printing time on the screen is for reference only, we make no guarantee that it is the actual printing time.)



Do not exceed the maximum scale

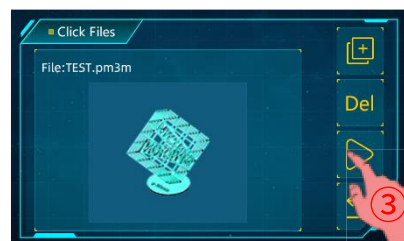
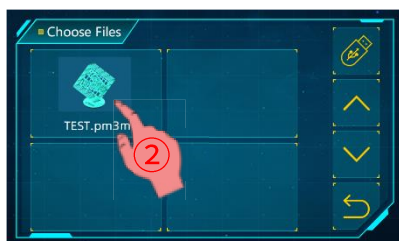

If it is necessary, click "Pause" to pause the printing and wait for platform rising automatically. Then click "Start" to resume printing.

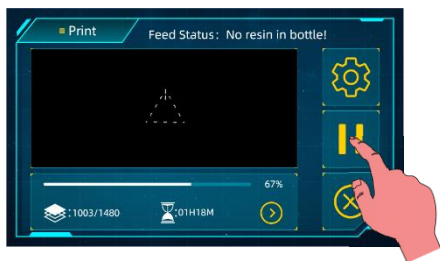

click to pause

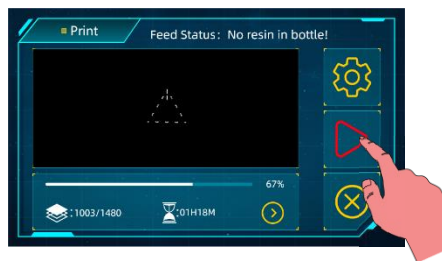

click to start

First Print Instructions

2. File list

Print file list is consist of USB driver file list and local file list. Select one USB driver file and click “  ” icon in its interface to save it to local file list. The local file can be printed without USB driver.

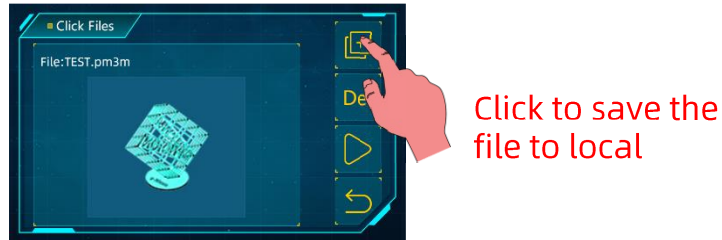

3. Exposure off compensation

Exposure off time is the interval between printing platform retracts to the lowest point and UV light turns on. When the exposure area is large during printing process, due to the surface tension and resin characteristic, there may be problems such as delay of Z-axis or delay of resin reflowing, causing print failure. **It is suggested to enable exposure off compensation to improve success rate.**



The compensation only works on bottom layers and layers with large area. In normal layers, off time is automatically added according to the area of layers; the larger the area, the longer the off time.

For large print objects, the compensation can reduce the risk of layers separation or base falling off to avoid print failure. For the smalls, it can prevent their bases from thickening.

Exposure off compensation, which is enabled by default, adds print time. If the print object or its area of layers is small, you can disable the function in Set up.

First Print Instructions

4. Handling models and residues

After printing, unscrew and remove the platform when resin stop dropping from the platform. The model can be removed by scraper. The removed model should be washed with ethanol 95vol% concentration. The printed model may need post curing to achieve better hardness by direct sunlight or UV-curing box.

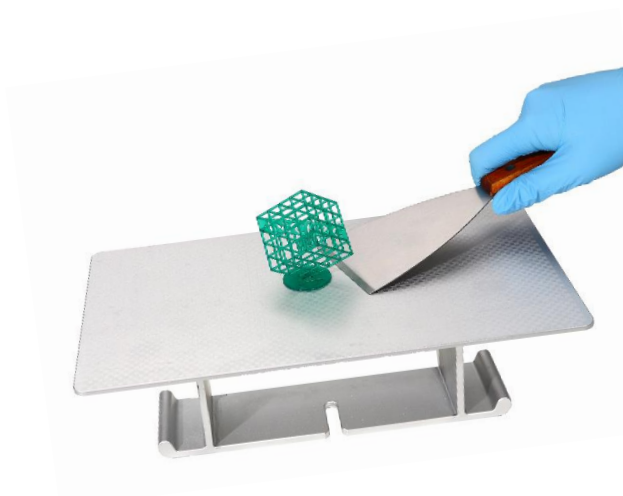

【IMPORTANT】 Inevitably, in case of incomplete curing or failed prints, there might be some cured resin left in the vat. It is suggested to filter the resin by a funnel and then store the liquid in a sealed container. The residues left on the platform or in the vat can be wiped off with paper towel.

Before each prints, please ensure there is no solid residues in the vat or on the platform, otherwise the FEP film may be crushed and broken during printing.

Slicing Software Overview

3D printer reads sliced file and prints models. It is necessary to convert 3D files (stl./obj.) into sliced files for machine to recognize. Software that realize the process is called slicing software, for example, Anycubic Photon Workshop.

Anycubic Photon Workshop can be used to export sliced file. You should select **Anycubic Photon M3 Max** as machine type first, then manipulate the model and set the parameters. Lastly, export the sliced file (.pm3m).

The instruction of Anycubic Photon Workshop has been saved in the USB memory, it is recommended that read it carefully if it is the first time for you to use Anycubic Photon Workshop.

FAQ and Machine Maintenance

1. FAQ

(1) Model do not stick to platform

- Bottom exposure time is insufficient, increase the exposure time.
- Contact area between the model and platform is small, please add raft.
- Bad leveling.

(2) Layer separation or splitting

- The machine is not stable during printing.
- FEP film in the vat is not tight enough or it need a change for new one.
- The printing platform or resin vat is not tightened.
- The lift speed is too fast.
- The printing object is hollowed without punching.

(3) Layer shift

- Add supports.
- Reduce the lift speed.

(4) Floccules left in resin vat or attached to models

- The exposure time is too long. Reduce the normal exposure time and bottom exposure time.

2. Machine maintenance



- (1) If Z axis make noisy sound, please apply lubricant to Z lead screw.

FAQ and Machine Maintenance

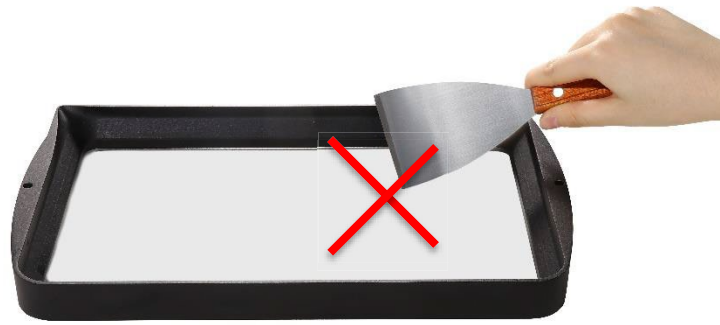

(2) Clean off the residues cured on FEP film when the printing fail: Set full-screen exposure for 20s and then remove the cured resin sheet to protect the film. Do not use sharp objects to scrape off the residues on FEP film.



(3) Be careful when remove the platform, do not let it fall to damage the machine.

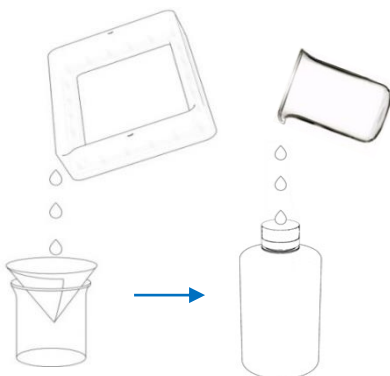

(4) Do not left resin in resin vat for over two days when it is unused. Please filter and store the resin properly.

FAQ and Machine Maintenance

(5) After printing, please clean up the platform (**wipe with paper towels or wash with alcohol**), and ensure no residue left (**filter the residue with funnel**).

(6) If the body of printer is stained with resin, use alcohol to clean.

(7) Please clean the resin vat first before you change resin.

Thank you for purchasing **ANYCUBIC** products! Under normal usage and service, the products have a warranty period up to one year. Please visit **ANYCUBIC** support center(support.anycubic.com/en) to report any issue with **ANYCUBIC** products. Our professional after-sale service team would respond within 24 hours and solve the issues.