

FUJIFILM

EN

instax WIDE 400

INSTANT CAMERA



User's Guide/Safety Precautions

FI027-EN-WW-01



**Caution when handling the INSTAX WIDE
instant film cartridge**

EN Do not open the back camera cover until you have used all photos in the loaded INSTAX WIDE film cartridge. Opening the camera door will expose the remainder of the unused film cartridge, turning it white and rendering it no longer usable.



How to open the film door

1

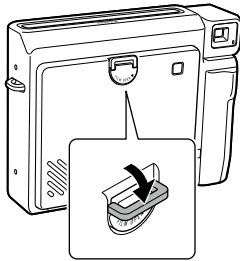

2



3

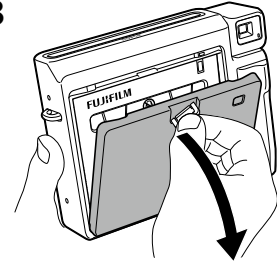

1. Pull the film door lock downwards.
2. Rotate the latch anti-clockwise until you feel tension (it will be in a diagonal position).
*Do not apply excessive force when turning the latch, this may cause damage.
3. Pull the latch towards you to open the film door.

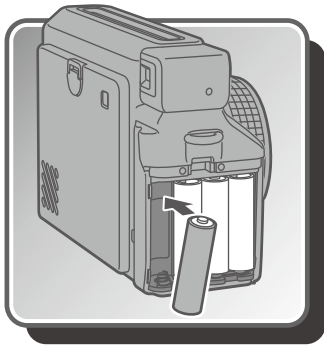

1

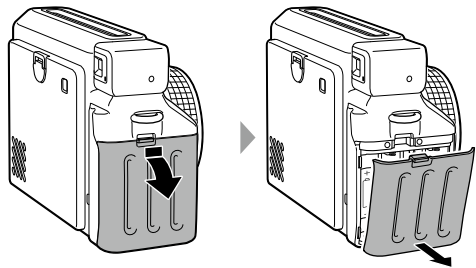

2

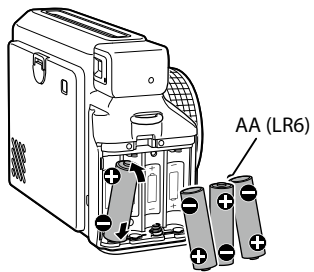

3

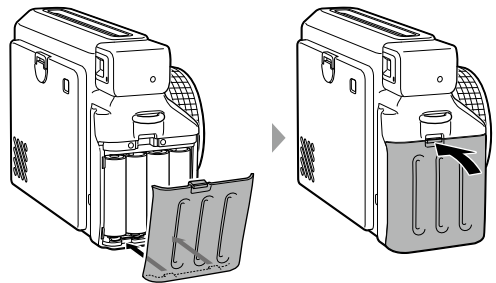

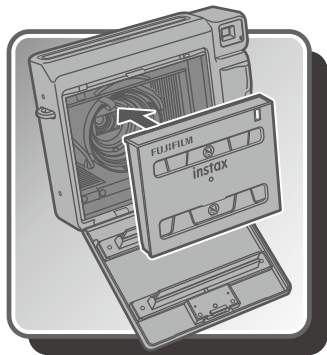

1

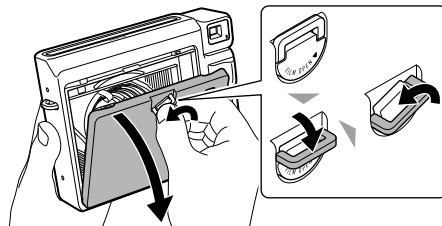

2

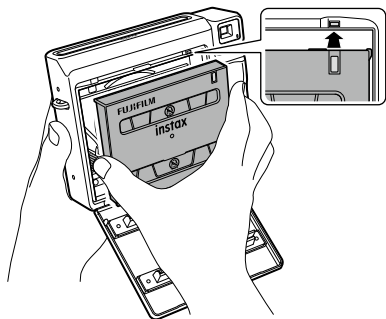

3

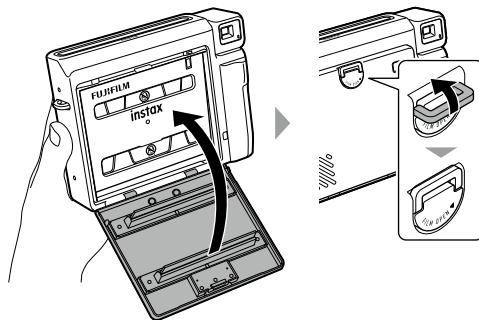

- To learn how to take photos, refer to the English pages. (pages from 10)

Before use

Before using the camera, check you have the following:

Supplied Accessories

- Shoulder strap (1)

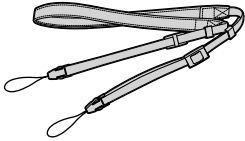

- Camera angle adjustment accessory (1)

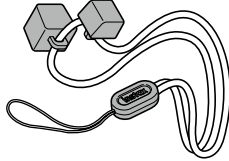

- AA-size alkaline batteries (LR6) (4)

- User's Guide (1)

- Close-up lens (1)

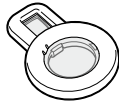

Part names

Front

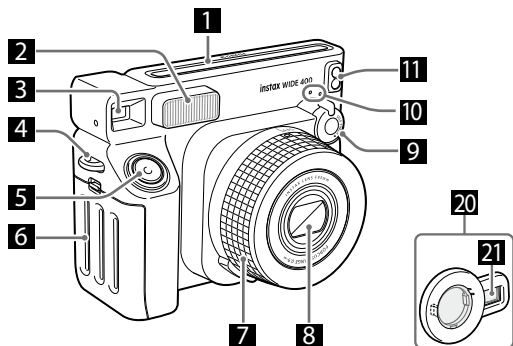

Rear

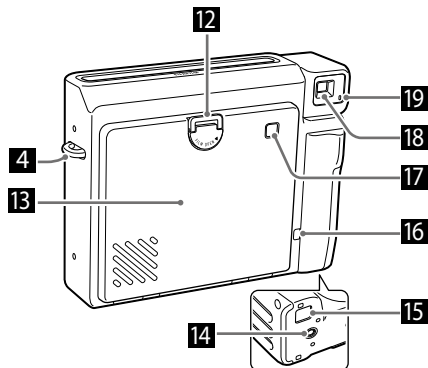

- 1 Film ejection slot
- 2 Flash
- 3 Viewfinder
- 4 Strap hook
- 5 Shutter button
- 6 Battery cover
- 7 Lens ring / Power
- 8 Lens cover / Lens
- 9 Self-timer lever
- 10 Self-timer lamp
- 11 Light sensors (AE light sensor / Flash light sensor)
- 12 Film cover lock
- 13 Film door
- 14 Tripod mount (Tripod is not supplied)
- 15 Location for camera-angle adjustment accessory
- 16 Film counter
- 17 Film confirmation window
- 18 Viewfinder eyepiece
- 19 Flash charging lamp
- 20 Close-up lens (supplied)
- 21 Selfie mirror

Attaching the strap

To attach the shoulder strap

Attach the shoulder strap as illustrated below.

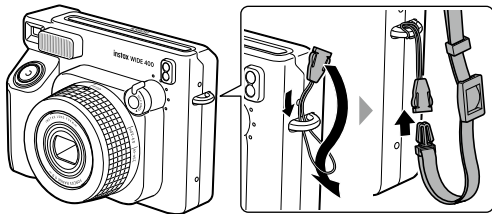
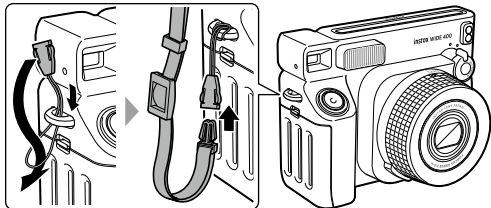

- Use the strap over your shoulder, not around your neck.
- Make sure the shoulder strap does not hang over the film ejection slot.

To attach the camera angle adjustment accessory

Attach it to the strap hook on the shutter button side as illustrated below.

The camera angle adjustment accessory can also be used as a simple pedestal (page 16).

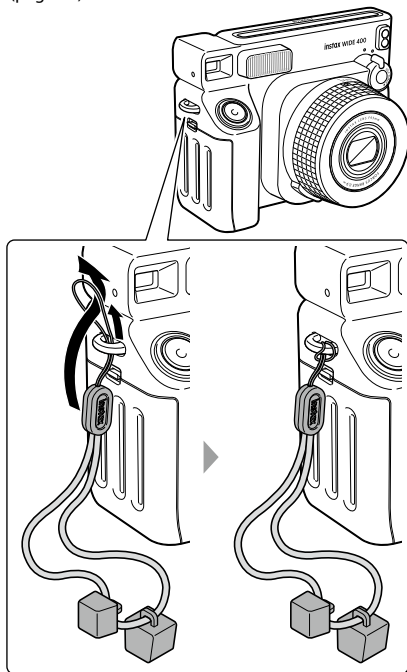

Preparing to take photos

1 Insert the film cartridge into the camera.

For details on how to load the film cartridge, see page 5.

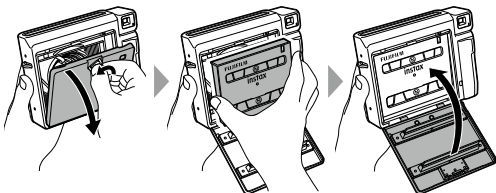

2 Rotate the lens ring to '0.9 – 3.0m' for short distances and '3.0m – ∞' for long distances.

The lens barrel extends and the camera is turned on. The self-timer lamp (top) will turn on.

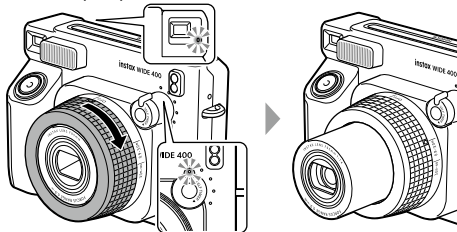

3 Press the shutter button.

The camera ejects the protective cover. Once the ejection sound stops, take the edge of the protective cover and pull it out.

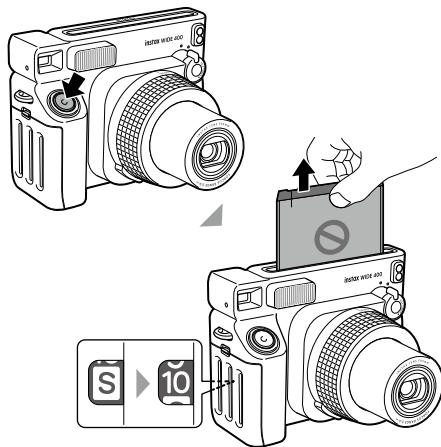

Do not open the film door until you have used all photos in the loaded INSTAX WIDE film cartridge (until "0" appears on the counter). Opening the film door will expose the remainder of the unused film cartridge, turning it white and rendering it no longer usable.

Taking photos

To use the close-up lens, see page 13.

1 Rotate the lens ring to '0.9 – 3.0m' for short distances and '3.0m – ∞' for long distances.

The lens barrel extends, and the camera is turned on. The camera is ready to take photos when the self-timer lamp (top) changes from blinking (flash charging) to lit.

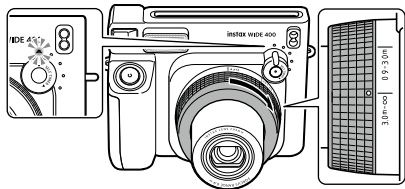

2 Decide your composition.

Look into the viewfinder so that the  marker in the viewfinder appears in the center of your subject.

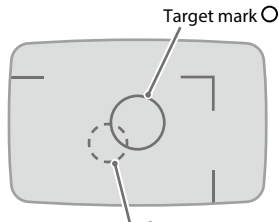

This target marker  should be used when the close-up lens is mounted. For details on taking close-ups, see page 13.

Portrait



Landscape



- Hold the camera so that the flash is at the top when taking a portrait photo.
- Take care that a finger, the strap, or camera angle adjustment accessory does not cover the flash, light sensors, lens, or film ejection slot.

3 Press the shutter button to take a photo.

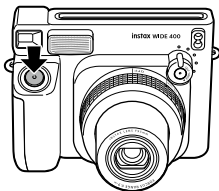

- Be careful not to touch the lens when you press the shutter button.
- You cannot take a photo when the flash is charging.

4 Once the ejection sound stops, take the edge of the ejected film and pull it out.

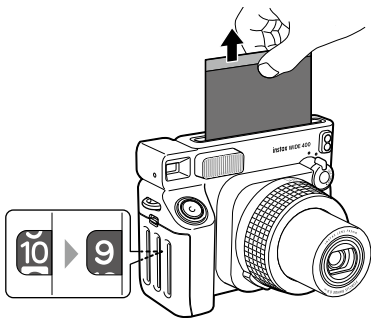

- Film development time is approximately 90 seconds (time varies depending on temperature).

5 Rotate the lens ring to the "OFF" position after taking photos.

The lens unit will be retracted, and the camera turns off.

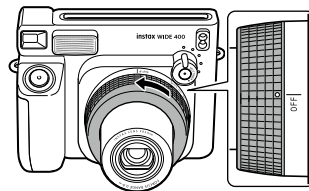

- If the camera malfunctions, remove the batteries while the power is on and then reinsert them to reset the camera.
- The camera automatically turns off if you leave the power on for about 5 minutes.

Removing the film cartridge

The film counter decreases in numerical order, counting down from "10" with each photo taken. "0" will be displayed when the film is finished and after the last photo has been taken.

When the counter reaches "0", turn off the power and remove the film cartridge.

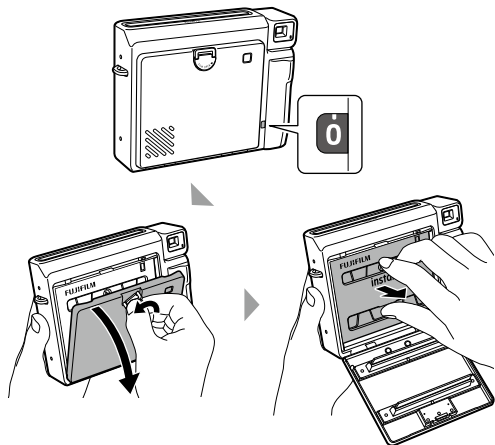

Do not remove the film cartridge until the film is used up (until the counter reaches "0"). The film will become exposed and become unusable.

Using the close-up lens

Close-up mode allows you to get close to the subject. Take selfies, easily, using the close-up lens and built-in selfie mirror.

To mount the close-up lens

1 Rotate the lens ring to the "0.9 – 3.0m" position.

The lens barrel extends and the camera is turned on.

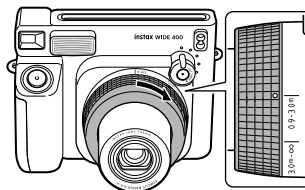

2 Insert the close-up lens straight on to the lens, with the selfie mirror facing away from the shutter button.

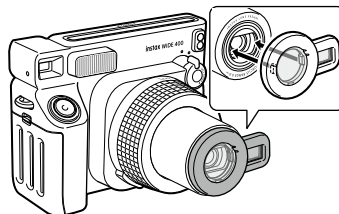

To unmount the close-up lens

Unmount the close-up lens by holding the back of the selfie mirror.

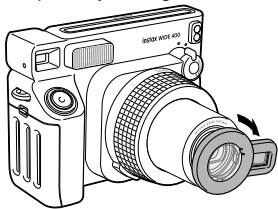

To take close-up photos

1 Decide your composition.

For close-ups, use the  marker found in the viewfinder, and place it over the center of your subject.

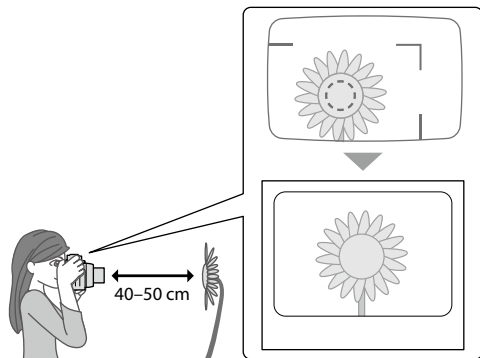
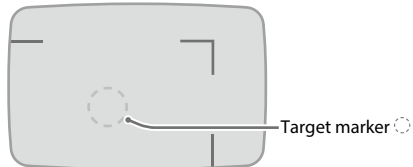

2 Press the shutter button to take a photo.

How to take a selfie

Use the close-up lens attachment, and make sure you can see yourself in the selfie mirror, then you can take a photo.

- 1 Hold the camera securely so that your face is 40 to 50 cm away from the end of the lens.

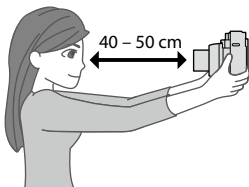

- 2 Check the composition with the selfie mirror, and take a photo.

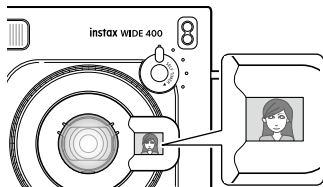

Using the self-timer

You can take group photos and selfies using the self-timer. The self-timer has four timing options: 4-seconds, 6-seconds, 8-seconds and 10-seconds.

- 1 Rotate the lens ring to '0.9 – 3.0m' for short distances and '3.0m – ∞' for long distances.

The lens barrel extends and the camera is turned on.

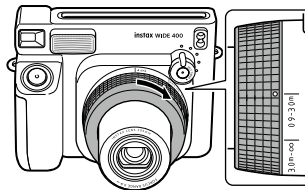

- 2 Turn the self-timer lever to select your timing option.

When you turn the self-timer lever, the lamps will light up sequentially. When the lamp lights up the timing option you wish to use, release your finger from the lever.

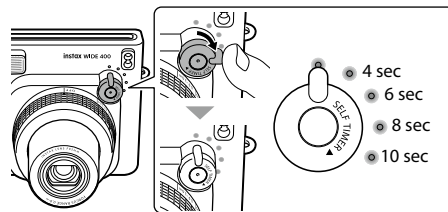

- Even if you release your finger halfway through, you can turn the lever again and select the time again.

* You can only extend the time.

3 Press the shutter button to take a photo.

When you press the shutter button, the self-timer lamp lights up, and the camera makes a timer sound. The lamp will turn off every 2 seconds, and a countdown will begin. The shutter will be released automatically when all lamps are turned off.

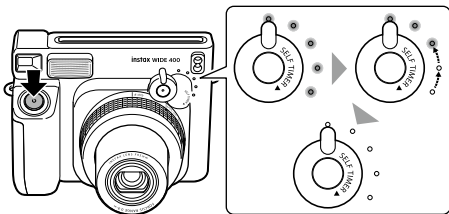

To cancel the self-timer

Rotate the lens ring to the "OFF" position after taking photos.

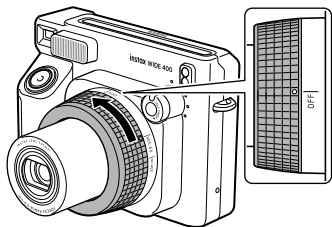

Using the camera angle adjustment accessory

The included camera angle adjustment accessory can be used as a pedestal for the camera. The camera angle adjustment accessory has two pedestals that allow you to adjust different viewing angles.

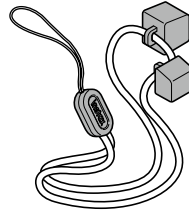

1 Install one of the pedestals in the camera angle adjustment accessory installation frame on the bottom of the camera.

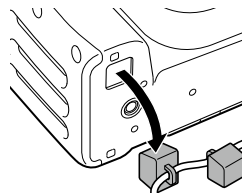

- In order to adjust the angle the lens, install it so that the higher side of the pedestal is facing the lens side.

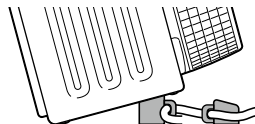

2 Press the shutter button to take a photo.

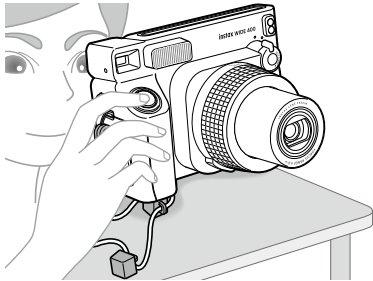

- You can also use functions such as normal shooting and self-timer without any problems.

Precautions when taking photos

Precautions when holding the camera





Correct way to hold



Do not cover the flash with a finger



Do not cover the light sensors with a finger

- Take care that a finger, the strap, or camera angle adjustment accessory does not cover the flash light sensor, AE light sensor, flash, lens, or film ejection slot.
- Hold the camera so that the flash is at the top when taking a landscape photo.
- Do not take photos in locations where flash photography is forbidden.
- Do not grasp the lens barrel when holding the camera. The finished photos may be adversely affected.
- Look into the viewfinder so that the  marker (the  marker in the close-up mode) in the viewfinder appears in the center of your subject.
- Be careful not to touch the lens when you press the shutter button.

Distances for normal (standard) mode and close-up mode

In normal (standard) mode, take a picture at a distance of at least 0.9 m from the subject. The effective flash range is up to approximately 3.0 m. Use close-up mode when holding the camera closer than 0.9 m from the subject. Close-up mode allows you to take photos at a range of 40 to 50 cm from the subject.

Self-timer lamp (top) status and error solutions

Self-timer lamp (top) status	Description
Lit	Ready to take a photo.
Off	Camera is off.
Flashing (slow)	The flash is charging. Please wait until the self-timer lamp (top) light stops flashing, and the light is on.
Flashing (fast & slow)	The battery voltage is low.
Flashing (fast)	An error has occurred. <ul style="list-style-type: none">• The film is jammed.• Incorrect lens ring position.• Other error

Main errors	Solutions
The battery voltage is low	Replace the batteries with new ones (alkaline batteries).
Film jammed	Do not forcibly pull out the film, remove the batteries, and reinsert new batteries (alkaline batteries). It may be possible to eject the film.
Incorrect lens ring position	Set the lens ring in the proper position.
Other	The camera may be malfunctioning. Remove and reinsert the batteries while the power is on.

IMPORTANT SAFETY NOTICE

- Do not use this product and its accessories for a purpose other than taking photos.
- This product has been designed with safety in mind, but please read the following safety precautions carefully and then use the product correctly.
- After reading this User's Guide, be sure to keep it in an easy-to-access place where you can refer to it whenever necessary.







WARNING

This symbol indicates danger, which could result in injury or death. Please follow these instructions.



CAUTION

This indicates a matter that may lead to injury or physical damage if ignored or incorrectly handled.









WARNING

-  Never attempt to take this product apart. You may be injured.
-  Do not touch this product if the inside of it becomes exposed due to dropping, etc. This product has high-voltage circuitry that may cause injury or electric shock.
-  If you notice anything abnormal, such as the camera (batteries) becoming hot, emitting smoke, or making a burning smell, remove the batteries immediately. Fire or burns may occur (be careful not to burn yourself when removing the batteries).
-  Never take flash photographs of people riding bicycles, driving cars, skateboarding, riding a horse and the like. The flash can be startling, distract, frighten animals, and otherwise cause an accident.
-  If you drop the camera in water or if water or a piece of metal or other foreign object gets inside, remove the batteries immediately. Heat generation or fire may occur.
-  Do not use this camera in places where there is flammable gas

or near open gasoline, benzene, paint thinner or other unstable substances which can give off dangerous vapors. Failure to do this could result in explosion or fire.

-  Do not disassemble, heat the batteries, throw them in a fire, or put them in an electrical short circuit. The batteries may rupture.
-  Use only AA (LR6) batteries. Heat generation or fire may occur if other batteries are used.
-  Keep batteries out of the reach of infants. An infant may accidentally swallow a battery. In the event that a battery is swallowed, seek medical attention immediately.

CAUTION

-  If the camera is not functioning correctly, to avoid injury do not attempt to repair yourself.
-  Do not touch any parts inside of the back cover. This may cause injury.
-  Do not handle this product with wet hands. Electric shock may occur.
-  Keep the product out of the reach of infants and small children. Injury may occur.
-  Do not cover or wrap the camera in a cloth or blanket. This can cause heat to build up and distort the casing or cause a fire.
-  Using a flash too close to a person's eyes may for the short term affect their eyesight. Take care when taking pictures of infants and young children.
-  Take care not to make a mistake with the \oplus and \ominus polarities when inserting the AA (LR6) batteries. Damages to the surroundings may occur due to the camera being damaged or its battery fluid leaking out.
-  Do not touch moving parts inside the camera. You may be injured.



The "CE" mark certifies that this product satisfies the requirements of the European Union (EU) regarding safety, public health, environment, and consumer protection. ("CE" is the abbreviation of Conformité Européenne.)



The "UKCA" mark certifies that this product satisfies the requirements of Great Britain (England, Scotland, Wales) regarding safety, public health, environment and consumer protection.

*UKCA: UK Conformity Assessed.

■ Legally required regulation compliance displays are located on the inside of the back cover of the camera.

■ Handling the camera

1. **Do not open the film door until you have used up the film. If you open it halfway, the film will be exposed to light and turn white, rendering the film unusable.**
2. The camera is a precision instrument, so do not get it wet, drop it, or subject it to shock. Also, do not place the camera where it will be exposed to sand or grit.
3. Do not use solvent such as paint thinner or alcohol to wipe off dirt.
4. Any dirt or dust in the film chamber will affect the finish of the print. Do not allow the film chamber to get dirty or dusty.
5. Do not leave the camera in a closed motor vehicle, another hot place, a humid place, on the beach, etc., for any period of time.
6. Gas containing moth repellent may adversely affect the camera and film. Avoid keeping the camera and film in a chest of drawers, etc. with mothballs.
7. The operating temperature range of this camera is +5°C to +40°C.
8. When taking photos, please be careful not to violate the rights of others, such as copyright, image rights, and privacy, or violate public order. Any act that violates the rights of others, or is contrary to public order or morals, or constitutes a nuisance, is subject to legal penalties and claims for damages.
9. This camera is for general household use. It is not suitable for commercial photography and other applications where a large number of prints are used.
10. Before using a commercially available strap, check the strength of the strap. Be especially careful when using a strap for mobile phones and smartphones because such straps are made for lightweight devices.

11. If you are not using your camera for a long period, take out the batteries and keep it where it will avoid heat, dust and moisture.
12. Remove soil and dust from the viewfinder window, etc., with an air blower and by wiping gently with a piece of soft cloth.

■ Cautions when printing



■ Handling INSTAX WIDE Film and Photos

For details on the handling of film and photos, see the instructions written on the FUJIFILM Instant Film INSTAX WIDE packaging.

1. Keep film in a cool place. In particular, do not leave film in an extremely hot place, such as in a closed motor vehicle, for a long period of time.
2. Do not make a hole in film or tear or cut film. Do not use film that is damaged.
3. Use film as soon as possible after inserting it in the camera.
4. If film has been kept in a place where the temperature is extremely low or high, allow it to become accustomed to a normal temperature before taking pictures.
5. Use film before the film expiration date referenced on the packaging.
6. Avoid airport checked luggage inspection and other strong X-ray exposure. Unused film is susceptible to the effect of fogging, etc. We recommend that you carry film onto aircraft in carry-on luggage (check with the relevant airport for more information).
7. Avoid exposing photos to strong light, and store them in a cool and dry place.
8. Do not cut or disassemble the INSTAX WIDE Film as it contains black caustic alkali paste. Be especially careful not to let infants or pets put the film into their mouths. Also take care that the paste does not come into contact with skin and clothes.

9. If you accidentally touch the paste of unused film, immediately wash it off with plenty of water. If the paste comes into contact with the eyes or mouth, wash the area and then seek medical attention. The alkalinity of this film will weaken approximately 10 minutes after the photo is ejected from the camera.
10. Do not store photos in a sealed bag, as this may cause discoloration.
11. Do not touch the film during development.

■ Caution: Handling the Film and Photo Prints

For details, see the instructions on the FUJIFILM INSTAX WIDE Instant Film packaging.



Notes on disposing of the camera



Disposal of Electrical and Electronic Equipment in Private Households
Disposal of used Electrical & Electronic Equipment (Applicable in the European Union and other European countries with separate collection systems)

This symbol on the product, in the manual and in the warranty, and/or on its packaging indicates that this product should not be treated as household waste. Instead it should be taken to an appropriate collection point for the recycling of electrical and electronic equipment.

By ensuring this product is disposed of correctly, you will help prevent potential negative consequences to the environment and human health, which could otherwise be caused by inappropriate waste handling of this product.

The recycling of materials will help to conserve natural resources. For more detailed information about recycling this product, please contact your local city office, your household waste disposal service or the shop where you purchased the product.

In Countries outside of EU: If you wish to discard this product, please contact your local authorities and ask for the correct way of disposal.

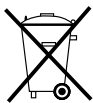

This Symbol on the batteries or accumulators indicates that those batteries should not be treated as household waste.

For customers in Turkey:

EEE Complies with Directive.

Specifications

Film	FUJIFILM INSTAX WIDE FILM
Photo Picture Size	62 mm × 99 mm
Lens	Retractable lens, 2 components, 2 elements, f = 95 mm, 1:14
Viewfinder	Real image finder, 0.37×, with target spot
Shooting Range	Manual 2-range switching (0.9 m – 3 m/3 m and beyond), Normal Mode (0.9 m - 3 m) Landscape Mode (3 m and beyond)
Shutter	Programmed electronic shutter release, 1/64 sec – 1/200 sec.
Exposure Control	Automatic, Lv 10.5 to 15 (ISO 800)
Film Ejection	Automatic
Film Developing Time	Approx. 90 seconds (varies depending on the ambient temperature)
Flash	Built-in, automatic electronic flash (automatic light adjustment), Recycle time: 7 seconds or less (when using new batteries), Effective flash range: 0.9 to 3 m
Power Supply	Four AA-size alkaline batteries (LR6), Capacity: approx. 10 INSTAX WIDE film cartridges of 10 exposures each (depends on usage conditions) * The supplied batteries are for trial use. When they run out, replace them with new ones (alkaline batteries). The performance of alkaline batteries varies depending on the brand. * Manganese batteries cannot be used.
Auto Power Off Time	After 5 minutes
Others	Film counter, film cartridge confirmation window, tripod socket (tripod sold separately).
Dimensions	162 mm × 98 mm × 123 mm
Weight	616 g (without battery, strap, film cartridge, and close-up lens)

* The above specifications are subject to change for better performance.

Information for traceability in Europe

Manufacturer: FUJIFILM Corporation
7-3, Akasaka 9-Chome, Minato-ku, Tokyo
Japan

Authorized representative in Europe:
FUJIFILM Europe GmbH
Balcke-Duerr-Allee 6, 40882 Ratingen
Germany

EU Importer : FUJIFILM Europe B.V.
Oudenstaart 1, 5047 TK Tilburg
The Netherlands

UK Importer : FUJIFILM UK Limited
Fujifilm House, Whitbread Way,
Bedford, Bedfordshire, MK42 0ZE
UK

[**en**] If you have any inquiries about this product, please contact a FUJIFILM authorized distributor, or visit the website below.

[**de**] Falls Sie Fragen zu diesem Produkt haben, beziehen Sie sich bitte auf die Details auf der beiliegenden Kundendienstkarte oder besuchen Sie die unten angegebene Website.

[**fr**] Si vous avez des questions sur ce produit, veuillez vous adresser à un distributeur Fujifilm agréé, ou consultez le site web ci-dessous.

[**es**] Si tuviera alguna pregunta sobre este producto, consulte la información en la tarjeta de servicio adjunta o visite el siguiente sitio web.

[**zht**] 如果您對本產品有任何疑問，請參閱隨附的服務卡上的詳情，或訪問以下網站。

[**ko**] 이 제품에 대해 문의가 있을 때에는, 동봉된 서비스 카드를 참조하시거나 아래의 웹 사이트를 방문하여 주십시오.

[**pt**] Caso tenha alguma questão acerca deste produto, por favor, contacte um distribuidor autorizado FUJIFILM, ou aceda ao website abaixo.

[**ru**] Если у Вас есть любые вопросы относительно этого изделия, обратитесь к авторизованному дистрибьютору FUJIFILM или посетите следующий веб-сайт.

[**it**] In caso di domande relative al prodotto, contattare un distributore autorizzato FUJIFILM o accedere al sito web riportato di seguito.

[**nl**] Als u vragen hebt over dit product, gelieve contact op te nemen met een geautoriseerde FUJIFILM-distributeur of ga naar de onderstaande website.

[**pl**] Jeśli masz jakieś pytania dotyczące tego produktu, skontaktuj się z autoryzowanym dystrybutorem FUJIFILM lub odwiedź witrynę internetową podaną poniżej.

[**cs**] Máte-li jakékoli dotazy týkající se tohoto výrobku, obraťte se prosím na autorizovaného distributora spoločnosti FUJIFILM nebo navštivte níže uvedené webovové stránky.

[**sk**] Ak máte akékoľvek otázky týkajúce sa tohto výrobku, kontaktujte autorizovaného distribútora spoločnosti FUJIFILM, alebo si pozrite nižšie uvedenú webovú stránku.

[**hu**] A termékkel kapcsolatos bármely kérdésével kérjük, keresse fel a FUJIFILM egyik hivatalos forgalmazóját, vagy látogasson el az alábbi weboldalra.

[**uk**] Якщо маєте якісь запитання щодо цього виробу, будь ласка, зверніться до повноваженого представника FUJIFILM або завітайте на сайт, указаний далі.

<https://www.fujifilm.com/>

FUJIFILM

FUJIFILM Corporation

7-3, AKASAKA 9-CHOME, MINATO-KU, TOKYO 107-0052, JAPAN