

User manual  
Washer-dryer

HWD80-B14979  
HWD80-B14979S  
HWD100-B14979  
HWD100-B14979S  
HWD120-B14979  
HWD120-B14979S

EN

**Haier**

## Thank you for purchasing a Haier Product.

Please read these instructions carefully before using this appliance. The instructions contain important information which will help you get the best out of the appliance and ensure safe and proper installation, use and maintenance.

Keep this manual in a convenient place so you can always refer to it for the safe and proper use of the appliance.

If you sell the appliance, give it away, or leave it behind when you move house, make sure you also pass this manual so that the new owner can become familiar with the appliance and safety warnings.

### Legend



Warning – Important Safety information



General information and tips



Environmental information

### Disposal

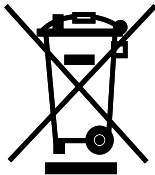

Help protect the environment and human health. Put the packaging in applicable containers to recycle it. Help to recycle waste of electrical and electronic appliances. Do not dispose appliances marked with this symbol with the household waste. Return the product to your local recycling facility or contact your municipal office.



### WARNING!

#### Risk of injury or suffocation!

Disconnect the appliance from the mains supply. Cut off the mains cable and dispose of it. Remove the door catch to prevent children and pets to get closed in the appliance.



### WARNING!

The appliance must not be supplied through an external switching device, such as a timer, or connected to a circuit that is regularly switched on and off by a utility.

1- Safety information.....	4
2- Product description.....	8
3- Control panel.....	9
4- Programmes .....	13
5- Consumption.....	14
6- Daily use .....	15
7- Eco-friendly use .....	20
8- Care and cleaning .....	21
9- Troubleshooting.....	24
10- Installation.....	28
11- Technical data .....	32
12- Customer service.....	34

Before switching on the appliance for the first time read the following safety hints:



## WARNING!

### Before first use

- ▶ Make sure there is no transport damage.
- ▶ Make sure all transport bolts are removed.
- ▶ Remove all packaging and keep out of children's reach.
- ▶ Handle the appliance always with at least two persons because it is heavy.

### Daily use

- ▶ This appliance can be used by children aged from 8 years and above and persons with reduced physical, sensory or mental capabilities or lack of experience and knowledge if they have been given supervision or instruction concerning use of the appliance in a safe way and understand the hazards involved.
- ▶ Keep away children under 3 years of age from the appliance unless they are constantly supervised.
- ▶ Children shall not play with the appliance.
- ▶ Do not let children or pets come close to the appliance when the door is open.
- ▶ Store washing agents out of reach of children.
- ▶ Pull up zips, fix loose threads and take care for small items to prevent laundry from being entangled. If necessary, use an appropriate bag or net.
- ▶ Do not touch or use the appliance when barefoot or with wet or damp hands or feet.
- ▶ Do not cover or encase the appliance during operation or afterwards to allow any moisture or dampness to evaporate.
- ▶ Do not place heavy objects or sources of heat or damp on top of the appliance.
- ▶ Do not use or store flammable detergent, sprays, dry cleaning agent or flammable gas in close vicinity to the appliance.
- ▶ Do not wash any garments treated with solvents in the appliance without having dried them previously in the air.



## WARNING!

### Daily use

- ▶ Do not remove or insert the plug in the presence of flammable gas.
- ▶ Do not hot wash foam rubber or sponge-like materials.
- ▶ Do not wash any laundry which is polluted with flour.
- ▶ Do not open detergent drawer during any wash cycle.
- ▶ Do not touch the door during the washing process, it gets hot.
- ▶ Do not open the door if the water level is visibly over the porthole.
- ▶ Do not force the door to open. The door is fitted with a self-lock device and will open shortly after the washing procedure is ended.
- ▶ Switch off the appliance after each wash programme and before undertaking any routine maintenance and disconnect the appliance from the electrical supply to save electricity and for safety.
- ▶ Hold the plug, not the cable, when unplugging the appliance.
- ▶ Do make sure the room is dry and well ventilated. The ambient temperature should be between 5 °C and 35 °C.
- ▶ Do not cover any ventilation openings in the base by a carpet or similar object.
- ▶ Keep the area around the appliance free of dust and lint.
- ▶ Do make sure that there is only laundry inside the appliance and no pets or children before you use it.
- ▶ Only dry textiles washed in water.
- ▶ Do make sure not to load more than nominal load.
- ▶ Remove all items such as lighters and matches from pockets.
- ▶ Use fabric softeners or similar products as specified by the manufacturer's packaging.
- ▶ Notice that the last part of the drying cycle occurs without heat (cool down cycle) to ensure the remaining garments are at a temperature which does not damage them.
- ▶ Do not leave the appliance unattended during run time for some time. If a long absence is intended, the drying cycle have to be interrupted by switching off the unit and unplugging the mains.
- ▶ Do not switch off the appliance except drying cycle is finished, unless all items are quickly removed and spread out that the heat can be released.



## WARNING!

### Daily use

- ▶ Do not dry following items in the appliance:
  - ▶ Items which are unwashed.
  - ▶ Items which have been contaminated with inflammable substances such as cooking oil, acetone, alcohol, benzene, petrol, kerosene, spot removers, turpentine, waxes, wax removers or other chemicals. The fumes can cause a fire or explosion. These items must always be washed first by hand in hot water with an extra amount of detergent and then be dried in the open air before drying in the appliance.
  - ▶ Items which contain padding or fillings (e.g. pillows, jackets), as the filling can get out with the risk of igniting in the appliance.
  - ▶ Items which contain a large proportion of rubber, foam rubber (latex foam) or rubber like materials such as shower caps, waterproof textiles, rubberised articles and items of clothing and pillows with foam rubber filling.
- ▶ Switch off the appliance after each drying programme to save electricity and for safety.

### Maintenance / cleaning

- ▶ Make sure children are supervised if they carry out cleaning and maintenance.
- ▶ Disconnect the appliance from the electrical supply before undertaking any routine maintenance.
- ▶ Keep the lower part of the porthole clean and open door and detergent drawer if appliance is not in use to prevent odours.
- ▶ Do not use water spray or steam to clean the appliance.
- ▶ Replace a damaged supply cord only by the manufacturer, its service agent or similarly qualified persons in order to avoid a hazard.
- ▶ Do not try to repair the appliance by yourself. In case of repair please contact our customer service.

## Installation

- ▶ Ensure a location which allows opening the door fully. Do not install the appliance behind a lockable door, a sliding door or a door with hinges on the opposite side of the appliance door as this limits the full opening of the appliance door.
- ▶ The appliance should be placed in a well-ventilated place. Ensure a location which allows opening the door fully.
- ▶ Never install the appliance outdoors in a damp place, or in an area which may be prone to water leaks such as under or near a sink unit. In the event of a water leak cut power supply and allow the machine to dry naturally.
- ▶ Install or use the appliance only where the temperature is above 5 °C.
- ▶ Do not place the appliance directly on a carpet, or close to a wall or furniture.
- ▶ Do not expose the appliance to any frost, heat or direct sunlight or in the near of heat sources (e.g. stoves, heaters).
- ▶ Make sure that the electrical information on the rating plate agrees with the power supply. If it does not, contact an electrician.
- ▶ Do not use multi-plug adapters and extension cables.
- ▶ Make sure only the delivered electric cable and hose set are used.
- ▶ Make sure not to damage the electric cable and the plug. If damaged have it replaced by an electrician.
- ▶ Use a separate earthed socket for the power supply which is easy accessible after installation. The appliance must be earthed.  
**Only for UK:** The appliance's power cable is fitted with 3-cord (grounding) plug that fits a standard 3-cord (grounded) socket. Never cut off or dismount the third pin (grounding). After the appliance is installed, the plug should be accessible.
- ▶ Make sure the hose joints and connections are firm and there is no leakage.

## Intended use

This appliance is intended for washing and drying machine-washable laundry only. Anytime follow the instructions given on the label of each garment label. It is designed exclusively for domestic use inside the house. It is not intended for commercial or industrial use.

Changes or modifications to the device are not allowed. Unintended use may cause hazards and loss of all warranty and liability claims.

**i Note:**

Due to technical changes and different models, the illustrations in the following chapters may differ from your model.

## 2.1 Picture of appliance

Front (Fig. 2-1):



Rear side (Fig. 2-2):

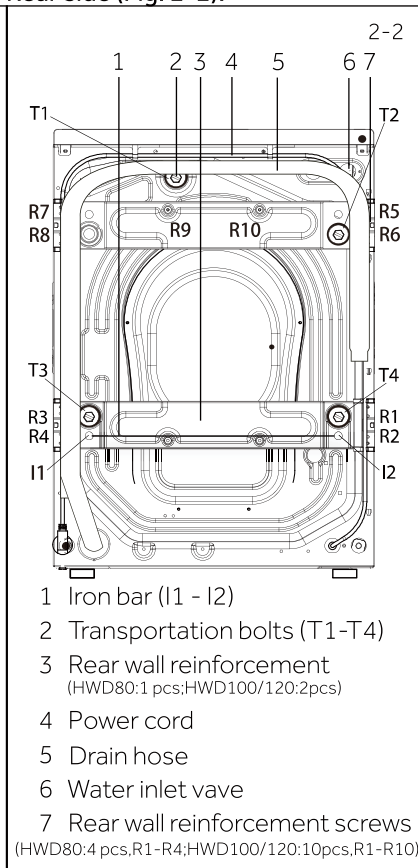

## 2.2 Accessories

Check the accessories and literature in accordance with this list (Fig.:2-3):

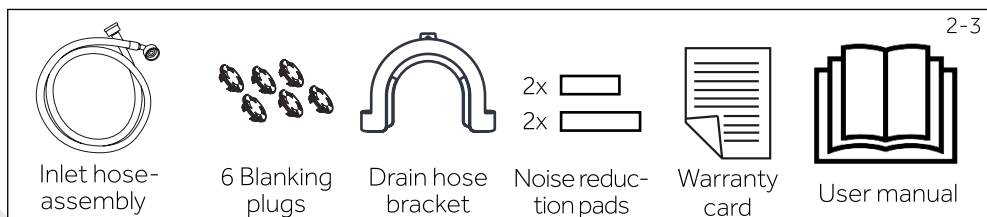



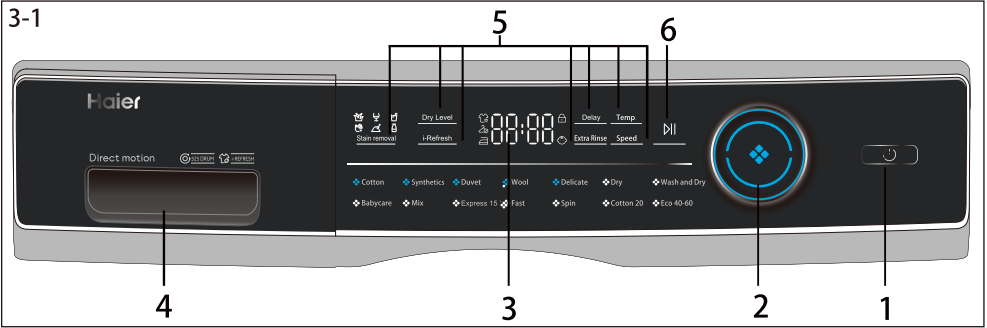

- 1 "Power" button
- 2 Programme selector
- 3 Display
- 4 Detergent /Softener drawer
- 5 Function buttons
- 6 "Start/Pause" button

## **i** Note : Acoustic signal

In following cases, an acoustic signal is no sounds by default:

- ▶ when pressing a button
- ▶ when turning the programmes selector
- ▶ at the end of programme

The acoustic signal can be selected if necessary ; see DAILY USE(see P19 6.13).

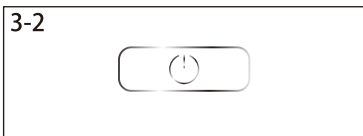

### 3.1 "Power" button

Touch this button (Fig. 3-2) gently to switch on, the display is shining, the indicator of the "Start/Pause" button is flashing. Touch it again for about 2 seconds to switch off. If no panel element or programme is activated after a while machine will shut down automatically.

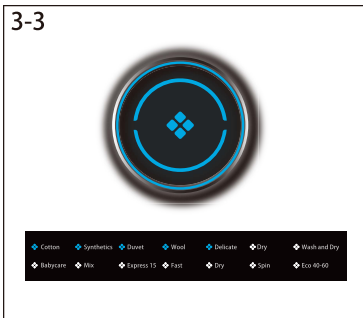

### 3.2 Programme selector

By turning the knob (Fig. 3-3) one of 14 programmes can be selected, related LED will light up, its default settings will be displayed.



### 3.3 Display

The display (Fig. 3-4) shows following information:

- ▶ Washing / Drying time
- ▶ End time delay
- ▶ Error codes and service information
- ▶ Function buttons and "Start/Pause" button

## 3.4 Detergent drawer

Open dispenser drawer, the following components can be seen (Fig. 3-5):

- 1: compartment for powder or liquid detergent.
- 2: detergent flap selector, lift it up for powder detergent keep it down for liquid detergent.
- 3: compartment for sanitizer.
- 4: compartment for softner.
- 5: lock tab, press it down to pull out dispenser drawer.

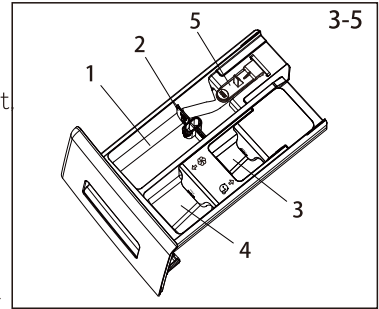

The recommendation on the type of detergents is suitable for the various washing temperatures, please refer to the manual of detergent(see P17).

## 3.5 Function buttons

The function buttons (Fig. 3-6) enable additional options in the selected programme before programme starts. The related indicators are displayed.

By switching off the appliance or setting a new programme, all options are disabled.

If a button has multiple options, the desired option can be selected by touching the button sequentially.

By touching the buttons, when it is in dull light, the function is unselected; when it is in bright light, the function is selected.

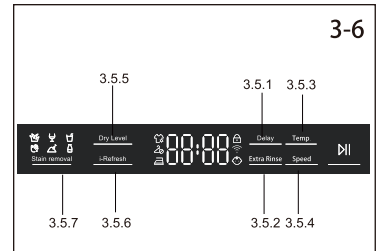

### **i** Note: Factory settings

To get best results in each programme Haier has well defined specific default settings. If there is no special requirement default settings are recommended.

### 3.5.1 Function button "Delay"

Touch this button (Fig. 3-7) to start the programme with a delay. End time delay could be increased in steps of 30 minutes from 0.5-24h. For example display off **6:30** means the cycle will finish in 6hours and 30 minutes. Touch "Start/Pause" button to activate the time delay. It is not applicable to programme Spin, Refresh, Eco 40-60. The time delay must be longer than the programme run time. Otherwise the programme will start immediately.

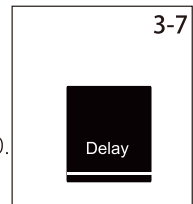

### **i** Note: Liquid detergent

If using liquid detergent, it is not recommended to activate the end time delay.

### 3.5.2 Function button "Extra Rinse"

Touch this button (Fig. 3-8) to rinse the laundry more intense with fresh water. This is recommended for people with sensitive skin. By touching the button several times one to three additional cycles can be selected. They appear in the display with P--1/P--2/P--3.

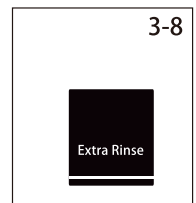

3-10

Temp.

**3.5.4 Function button "Temp."**

Touch this button (Fig. 3-10) to change the washing temperature of the programme. If no value is illuminated (the display "--") the water will not be heated.

3-11

Speed

**3.5.5 Function button "Speed"**

Touch this button (Fig. 3-11) to change or deselect the spin of the programme. If no value is illuminated the display "0") the laundry will not spin.

3-12

Dry Level

**3.5.6 Function button "Dry Level"**

Touch this button (Fig. 3-12) to change or deselect the drying level of the programme according to the needs.

Pic-1: Touch Dry Level button, then it lights up, it means that clothes can be stored directly after drying.

Pic-2: Touch Dry Level button, then it lights up, it means that clothes can be directly worn after drying.

Pic-3: Touch Dry Level button, then it lights up, it means that clothes will be good for ironing after drying.

Pic-1、 Pic-2、 Pic-3: Light up at the same time, then it display the fixed drying time.



Pic-1 Pic-2 Pic-3

3-13

i-Refresh

**3.5.7 Function button "i-Refresh"**

Touch this button (Fig. 3-13), the programme can be selected, i-Refresh icon will light up, and the indicator in the middle of the knob is on. Users select different "i-Refresh" time of the function according to their own needs. It is used for fresh odor removal, dust removal, mites removal, and moisture removal.

i-Refresh tips:

1. Please button and zip the clothes before i-Refresh. Clothing with adhesive lining, decoration (PU trim, diamond, buckle, buckle, pin, metal decorations, coating, pendants, etc.), adhesive, finalize the design of metal objects, please be careful.
2. i-Refresh care clothing should be dry clothing, if the clothes are wet or soaked, please air dry before i-Refresh care, such as i-Refresh wet clothes directly, there is a risk of shrinkage, deformation.
3. Please use soft cloth to protect the embroidery and decorations on the clothing surface in advance to avoid scratching the clothing surface.
4. Clothing with support (such as the skirt of wedding dress fabric) please take out the support before air washing care.
5. i-Refresh has the function of removing smell, please do not spray perfume, freshener, etc.
6. Please do not place too many clothes. Single care is recommended for best results.
7. Dust may remain on the door and window mat after i-Refresh. Please wipe the interlayer of the window mat and the door glass in time.
8. Not suitable for large, coated down jackets; Suitable for small, short down jacket care.

3-14

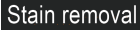
A rectangular button with the text "Stain removal" in white on a black background.

### 3.5.8 " Stain removal" button

Touch this button (Fig. 3-14) to choose special features for stains. The symbols are explained in the following table.

	Grass		Wine		Juice
	Blood		Soil		Milk

3-15



### 3.6 "Start/Pause" button

Touch this button (Fig. 3-15) gently to start or interrupt the currently displayed programme. During programme setting and during programme run the LED above the button is shining, or if interrupted blinking.

3-16

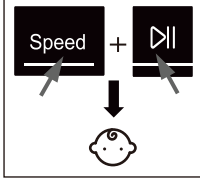

### 3.7 Child lock

Choosing a Program and then start,touch button" Speed"and "Start/Pause "( Fig .3-16) for 3 seconds simultaneously to block all panel elements against activation,p-anel display .For unlocking please touch again the two buttons.The child lock indicator lights up when the child lock works. Feature is optional when the machine is running.

3-17

A digital display showing the text "c | o | t" in a stylized font.

The display shows **c | o | t** (Fig. 3-17) if a button will be pressed, when the child lock is activated. The change is not running.

● Yes, ○ Optional, / No

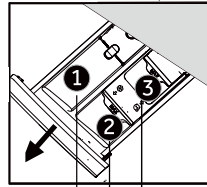

Detergent compartment for:

- 1 Detergent
- 2 Softener or care product
- 3 sanitizer<sup>3)</sup>

Programme	Max. load <sup>4)</sup>		Temperature in °C <sup>1)</sup>	selectable range	Preset	Detergent compartment			Fabrics type	Preset spin speed in rpm	Function				
	washing in kg	drying in kg				1	2	3			Dry Level	i-Refresh	Extra Rinse	Delay	Stain removal
	HWD80-B14979 HWD80-B14979S HWD100-B14979 HWD100-B14979S HWD120-B14979 HWD120-B14979S														
Cotton	8/10/12	5/6/8	* to 90	40	●	○	○	Cotton	1400	●	●	●	●	●	●
Synthetics	4/5/6	2.5/3/4	* to 60	40	●	○	○	Synthetic or mixed fabric	1200	●	●	●	●	●	●
Duvet	2/2.5/3	/	* to 40	30	●	/	/	Duvet	800	/	●	●	●	/	/
Wool	2/2.5/3	/	* to 40	*	●	/	/	Machine-washable fabric made of wool or with wool content	800	/	●	●	●	/	/
Delicate	2/2.5/3	/	* to 30	30	●	/	/	Delicate laundry and silk	600	/	●	●	●	/	/
Dry	/	5/6/8	/	/	/	/	/	Cotton / Synthetic	/	●	/	/	/	/	/
Wash and Dry	8/10/12	5/6/8	/	/	●	○	○	Cotton / Synthetic	1400	/	/	/	/	/	/
Babycare	4/5/6	2.5/3/4	* to 90	40	●	○	○	Cotton / Synthetic	1000	●	/	●	●	/	/
Mix	8/10/12	4/5/6	* to 60	30	●	○	○	Lightly soiled mixed-laundry of cotton and synthetic	1000	●	/	●	●	●	●
Express 15' <sup>2)</sup>	1	1	* to 40	*	●	○	/	Cotton / Synthetic	1000	●	/	●	●	/	/
Fast	8/10/12	4/5/6	* to 40	40	●	○	○	Cotton / Synthetic	1000	●	/	●	●	/	/
Spin	8/10/12	5/6/8	/	/	/	/	/	all fabrics	1000	●	/	/	/	/	/
Cotton 20°C	8/10/12	3/4/6	* to 20	20	●	○	○	Cotton	1000	●	/	●	●	/	/
Eco 40-60	8/10/12	/	/	/	●	○	○	/	1400	/	/	/	/	/	/

\* Water is not heated up.

1) Choose 90°C wash temperature only for special hygienic requirements.

2) Reduce detergent amount because programme duration is short.

3) Do not use chemical reaction with detergent.

4) Relating to dry laundry.

The design and specifications are subject to change without notice for quality improvement purposes.

User shall not add any sanitizer, detergent or softener to the i-Refresh programme.

The indicated consumption values may accordingly differ to local conditions.

Parameter		Programme			
		Eco 40-60*			Synthetic
Temperature in °C		40 °C	60 °C	60 °C	40 °C
Max. load in kg HWD80-B14979 HWD80-B14979S HWD100-B14979 HWD100-B14979S HWD120-B14979 HWD120-B14979S	Washing	–	–	8/10/12	–
	Drying	–	–	5/6/8	–
Energy in kW·h	Washing, spinning and drying	–	–	5.43/6.8/7.9	–
	Only for washing and spinning	–	–	0.91 /0.9/1.15	–
Water in L	Washing, spinning and drying	–	–	100/114/122	–
	Only for washing and spinning	–	–	57/62/65	–
Time in h:min	Washing and drying	–	–	11:15/11:55 /11:25	–
Spin drying performance in %		–	–	46/52/43	–

\* Standard programme for the Energy Labelling according to 96/60 EU:

Enter the European standard test procedure:

Washing: Select Eco 40-60, often touch speed for 5 seconds. After the temperature function is selectable, select the temperature and the maximum speed, touch Start button.

Drying: Select Eco 40-60, often touch speed for 5 seconds. After the temperature function is selectable, select Dry programme, often touch Dry Level for 5 seconds, then display "dr 3", touch Start button.

The standard Eco40-60\* cotton programmes are suitable to clean normally soiled cotton laundry. They are the most efficient programmes in terms of combined energy and water consumption for cotton laundry. Used water temperature may differ from declared cycle temperature.



## Note: Auto Weight

The appliance is equipped with a loading recognition. At low loading, energy, water and washing time will be reduced automatically in some programmes. The display shows **AUTO**.

### 6.1 Power supply

Connect the washing machine to a power supply (220V to 240V~/50Hz; Fig. 6-1). Please refer also to section Installation.

### 6.2. Water connection

- ▶ Before connecting check the cleanliness and clarity of the water inlet.
- ▶ Turn on the tap (Fig.6-2).

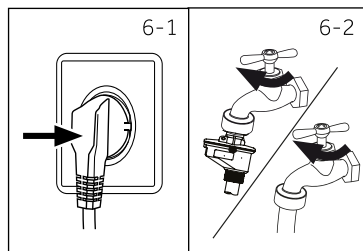

### **i** Note: Tightness

Before use check for leakage in the joints between the tap and the inlet hose by turning on the tap.

### 6.3 Preparing laundry

- ▶ Sort out clothes according to fabric (cotton, synthetics, wool or silk) and to how dirty they are (Fig. 6-3). Pay attention to the care labelling of washing labels.
- ▶ Separate white clothes from coloured ones. Wash coloured textiles first by hand to check if they fade or run.
- ▶ Empty pockets (keys, coins, etc.) and remove harder decorative objects (e.g. brooches) as well as flammable objects (paper tissues, lighters, matches etc.).
- ▶ Garments without hems, delicates and finely woven textile such as fine curtains are to be put into a wash bag to care for this delicate laundry (hand or dry cleaning would be better).
- ▶ Close zippers, velcro fastener and hooks, make sure the buttons are sewn on tightly.
- ▶ Place sensitive items like laundry without firm hem, delicate underwear (Dessous) and small items such as socks, belts, bras, etc. in a wash bag.
- ▶ Unfold large pieces of fabric such as bed sheets, bedspreads etc.
- ▶ Turn jeans and printed, decorated or color-intensive textiles inside out; possibly wash separately.

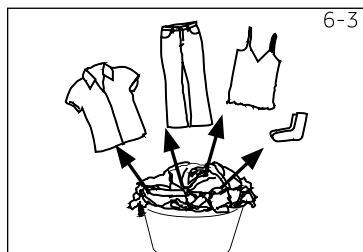

### **i** Note: Special hints for drying

- ▶ Sort clothes according to fabric(cotton, synthetics, etc.) desired dry level and equal residual moisture. Follow the instructions on the laundry label and dry only machine-dryable garments
- ▶ Spin the laundry with the maximum spin speed before drying.
- ▶ Do not exceed the max. load.
- ▶ Extra large pieces tend to wind up. If the laundry has not been sufficiently dry, loosen up the laundry and dry again with programme DRY.
- ▶ Especially delicate fabrics which can easily shrink or lose their shape, as well as e.g. silk stockings, lingerie etc. should not be dried with the appliance. Put delicate garments inside a laundry bag and avoid overdrying them.
- ▶ Jersey and knitwear should not be dried to avoid shrinkage.

## Care chart

### Washing



Washable up to 95 °C normal process



Washable up to 60 °C normal process



Washable up to 60 °C mild process



Washable up to 40 °C normal process



Washable up to 40 °C mild process



Washable up to 40 °C very mild process



Washable up to 30 °C normal process



Washable up to 30 °C mild process



Washable up to 30 °C very mild process



Wash by hand max. 40 °C



Do not wash

### Bleaching



Any bleaching allowed



Only oxygen/ non-chlorine



Do not bleach

### Drying



Tumble drying possible normal temperature



Tumble drying possible lower temperature



Do not tumble dryer



Line drying



Flat drying

### Ironing



Iron at a maximum temperature up to 200 °C



Iron at a medial temperature up to 150 °C



Iron at a low temperature up to 110 °C; without steam (steam ironing may cause irreversible damage)



Do not iron

### Professional Textile Care



Dry cleaning in tetra-chloroethene



Dry cleaning in hydrocarbons



Do not dry clean



Professional wet clean



Do not professional wet clean

## 6.4 Loading the appliance

- ▶ Put in the laundry piece by piece.
- ▶ Don't overload. Note the different maximum load according to programmes! Rule of thumb for maximum load: Check if you can put a hand upright on top of load.
- ▶ Close the door carefully. Make sure that no pieces of laundry are pinched.



### CAUTION!

Non-textile, as well as small, loose or sharp-edged items may cause malfunctions and damage of clothes and appliance.



## 6.5 Selecting detergent

- ▶ Washing efficiency and performance is determined by used detergent quality.
- ▶ Use only machine wash approved detergent.
- ▶ If needed use specific detergents, e.g. for synthetic and woolen fabric.
- ▶ Mind always detergent manufacturer recommendations.
- ▶ Do not use dry cleaning agents such as trichloroethylene and similar products.

## Choose the best detergent

Programme	Kind of detergent				
	Universal	Colour	Delicate	Special	Softener
Cotton	L/P	L/P	-	-	○
Synthetics	-	-	L/P	-	○
Duvet	-	-	L	L/P	-
Wool	-	-	L/P	L/P	-
Delicate	-	-	-	L/P	-
Dry	-	-	-	-	-
Wash and Dry	L/P	L/P	-	-	○
Babycare	L/P	L/P	-	-	○
Mix	L/P	L/P	-	-	○
Express 15'	L	L	-	-	○
Fast	L/P	L/P	-	-	○
Spin	-	-	-	-	-
Cotton 20°C	L/P	L/P	-	-	○
Eco 40-60	L/P	L/P	-	-	-

L = gel-/liquid detergent P = powder detergent ○ = optional - = no

If using liquid detergent, it is not recommended to activate the time delay.

We recommend by using:

- ▶ Laundry powder: 20 °C to 90 °C\* (best use: 40-60 °C)
- ▶ Color detergent: 20 °C to 60 °C (best use: 30-60 °C)
- ▶ Wool/delicate detergent: 20 °C to 30 °C (best use: 20-30 °C)

\* Choose 90 °C wash temperature only for special hygienic requirements.

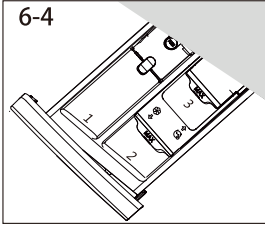

## 6.6 Adding detergent

1. Slide out the detergent drawer.
2. Put the required chemicals into corresponding compartments (Fig. 6-4),
3. Push back the drawer gently.

### **i** Note:

- ▶ Remove detergent residues before next wash cycle from the detergent drawer.
- ▶ Do not overuse detergent or softener.
- ▶ Please follow the instruction on the detergent package.
- ▶ Always fill the detergent just before the beginning of the wash cycle.
- ▶ Concentrated liquid detergent should be diluted before adding.
- ▶ Do not use liquid detergent if function "Delay" is selected.
- ▶ Carefully choose the programme settings according to the care symbols on all laundry labels and according to the programme table.

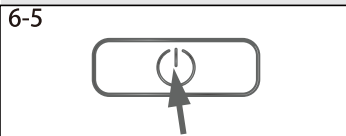

## 6.7 Switch on the appliance

Touch the "Power" button to switch on the appliance (Fig. 6-5). The LED of the "Start/Pause" button is flashing.

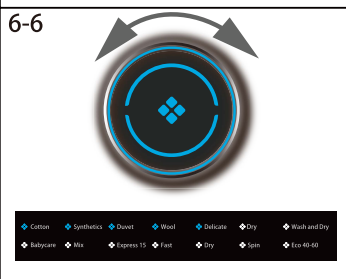

## 6.8 Select a programme

To get the best washing results, select a programme which fits the degree of soiling and sort of laundry type.

Turn the programme knob (Fig. 6-6) to select the right programme. Related programme LED lights up and the default settings are displayed.

### **i** Note: Odour removal

Before first use we recommended to run programme "COTTON+90 °C+600rpm" with no load and small amount of detergent in washing agent compartment (2) or special machine cleaner to remove possibly corruptive residues.

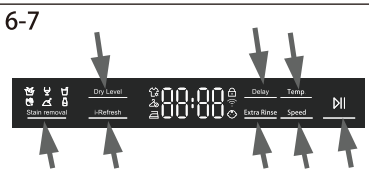

## 6.9 Add individual selections

Select required options and settings (Fig. 6-7); refer to Control panel.

### 6.10 Start wash programme

Touch "Start/Pause" button (Fig. 6-8) to start. The LED of the "Start/Pause" button stops flashing and lights up continuously. Appliance operates according to present settings. Changes are only possible by cancelling the programme.



### 6.11 Interrupt / cancel wash programme

To interrupt a running programme press gently "Start/Pause". The LED above the button is flashing. Press it again to resume operation.

To cancel a running programme and all its individual settings:

1. Touch "Start/Pause" button to interrupt the running programme.
2. Touch "Power" button for about 2 seconds to switch the appliance off.
3. Touch the "Power" button to turn on the appliance, select programme Spin and then select "no Speed" (speed lights are off) to drain the water.
4. Close the programme to restart the appliance, select a new programme and start it.

### 6.12 After washing



#### Note: Door lock

- ▶ For safety reasons the door is locked partially during the washing cycle. It is only possible to open the door at the end of the programme or after the programme was cancelled correctly (see description above).
- ▶ In case of high water level, high water temperature and during spinning it is not possible to open the door; Lock is displayed.

1. At programme cycle end END is displayed.
2. The appliance switches off automatically.
3. Remove laundry as soon as possible to go easy on it and to prevent more wrinkling.
4. Turn off the water supply.
5. Unplug the power cord.
6. Open the door to prevent formation of moisture and odours. Let it open while not used.



#### Note: Standby-mode / energy-saving mode

The switched on appliance will go into standby-mode if it will not be activated within 2 minutes before starting the program or at the end of program. The display switches off. This saves energy. To interrupt the standby mode touch "Power" button.



#### Note: Cool down cycle for drying cycle

The last part of the drying cycle occurs without heat to ensure remaining the garments at a temperature which does not damage them.

### 6.13 Activate or deactivate the buzzer

The acoustic signal can be deselected if necessary:

1. Switch on the appliance; 2. Select the Mix programme.
3. Touch the "Dry Level" and "Temp." button at the same time for about 3 seconds. "bEEP OFF" will be displayed and the buzzer will be deactivated. For activating the buzzer touch these two buttons at the same time again. "bEEP ON" will be displayed.



## Environmentally responsible use

### Washing

- ▶ To achieve best use of energy, water, detergent and time you should use the recommended maximum load size.
- ▶ Do not overload (hand width clearance above laundry).
- ▶ For slightly soiled laundry select the Express 15' programme.
- ▶ Apply exact dosages of each washing agent.
- ▶ Choose the lowest adequate washing temperature - modern detergents are efficiently cleaning below 60 °C.
- ▶ Raise default settings only due to heavy staining.
- ▶ Spin the laundry with the maximum spin speed if you want to use a drying programme afterwards.

### Drying

- ▶ Use the maximum filling amount of about 5/6/8 kg.
- ▶ Loosen up the laundry before starting the drying programme.
- ▶ Do not use softener when washing, because the laundry will become fluffy and soft in the dryer programme.

### 8.1 Cleaning the detergent drawer

Always take care there are no detergent residues. Clean the drawer regularly (Fig. 8-1):

1. Pull out the drawer until it stops.
2. Press the release button and remove the drawer.
3. Flush the drawer with water until it is clean and insert the drawer back in the appliance.

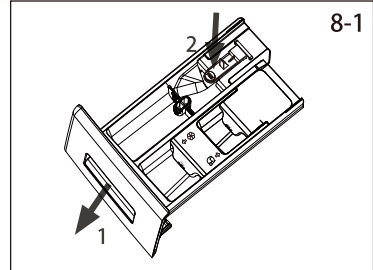

### 8.2 Cleaning the machine

- ▶ Unplug the machine during cleaning and maintenance.
- ▶ Use a soft cloth with soap liquid to clean the machine case (Fig. 8-2) and rubber components.
- ▶ Do not use organic chemicals or corrosive solvents.



### 8.3 Water inlet valve and inlet valve filter

To prevent blockage of water supply by solid substances like lime clean regularly the inlet valve filter.

- ▶ Unplug the power cord and turn off the water supply.
- ▶ Unscrew the water inlet hose at the back (Fig. 8-3) of the appliance as well as on the tap.
- ▶ Flush the filters with water and a brush (Fig. 8-4).
- ▶ Insert the filter and install the inlet hose.

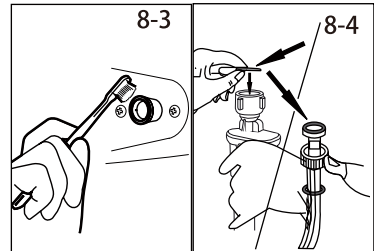

### 8.4 Cleaning the drum

- ▶ Remove accidentally washed items, especially metal parts such as pins, coins, etc. from the drum (Fig. 8-5) because they cause rust stains and damage.
- ▶ Use a non-chloride cleaner for removing rust stains. Observe the warning hints of the cleaning agent manufacturer.
- ▶ Do not use any hard objects or steel wool for cleaning.

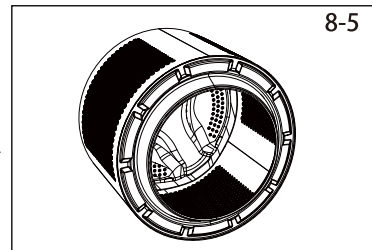

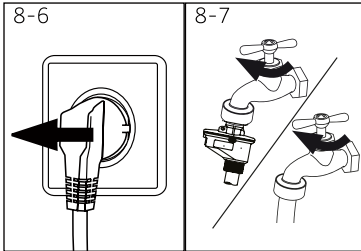

## 8.5 Long periods of disuse

If the appliance is left idle for a longer period:

1. Pull out the electrical plug (Fig. 8-6).
2. Turn off water supply (Fig. 8-7).
3. Open the door to prevent formation of moisture and odours. Let door open while not used.

Before next usage check carefully power cord, water inlet and drain hose. Make sure everything is properly installed and without leakage.

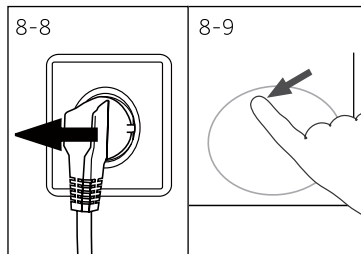

## 8.6 Pump filter

Clean the filter once a month and check the pump filter for instance if the appliance:

- ▶ Doesn't drain the water.
- ▶ Doesn't spin.
- ▶ Cause unusual noise while running.



### WARNING!

Scalding Risk! Water in the pump filter can be very hot! Before any action please ensure water has cooled down.

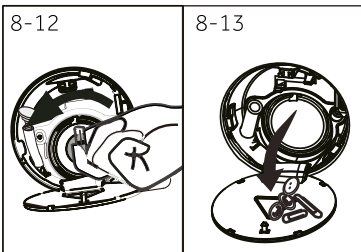
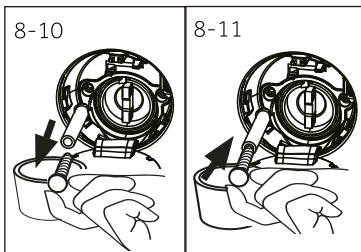

1. Turn off and unplug the machine (Fig. 8-8).
2. Push and open service flap (Fig. 8-9).
3. Provide a flat container to catch leach water (Fig. 8-10). There could be bigger amounts!
4. Pull the drainhose out and hold its end above the container (Fig. 8-10).
5. Take the sealing plug out of the drainhose (Fig. 8-10).
6. After complete drainage close drainhose (Fig. 8-11) and push it back into the machine.
7. Unscrew and remove counter clockwise the pump filter (Fig. 8-12).
8. Remove contaminants and dirt (Fig. 8-13).

9. Clean carefully pump filter, e.g. using running water (Fig. 8-14).
10. Refix it thoroughly (Fig. 8-15).
11. Close service flap.

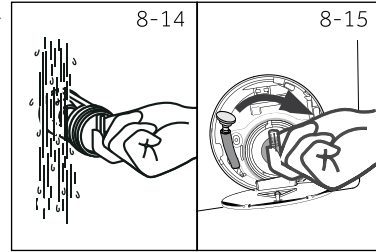
**CAUTION!**

- ▶ Pump filter sealing has to be clean and unhurt. If the lid is not full tightened, water can escape.
- ▶ The filter must be in place, or it may lead to leakage.

Many occurring problems could be solved by yourself without specific expertise. In case of a problem please check all shown possibilities and follow below instructions before you contact an after sales service. See CUSTOMER SERVICE.



## WARNING!

- ▶ Before maintenance, deactivate the appliance and disconnect the mains plug from the mains socket.
- ▶ Electrical equipment should be serviced only by qualified electrical experts, because improper repairs can cause considerable consequential damages.
- ▶ A damaged power cable should only be replaced by the manufacturer, its service agent or similarly qualified persons in order to avoid a hazard.

### 9.1 Information codes

Following codes are displayed only for information referring to the washing cycle. No measures must be performed.

Code	Message
01:25	The remaining wash cycle time will be 1 hour and 25 minutes.
06:30	The remaining wash cycle time including chosen end-time delay will be 6 hours and 30 minutes.
RLtD	Automatic load detection is working.
End	The washing cycle is finished. The appliance shuts off automatically.
cLo t	Function child lock is activated.
Loc t	Door is closed because of high water level, high water temperature or spinning cycle.
bEEP OFF	The buzzer is deactivated.
bEEP ON	The buzzer is activated.

### 9.2 Troubleshooting with display code

Problem	Cause	Solution
CLr FLTr	<ul style="list-style-type: none"> <li>• Drainage error, water is not fully drained within 6 minutes.</li> </ul>	<ul style="list-style-type: none"> <li>• Clean pump filter.</li> <li>• Check drain hose installation.</li> </ul>
E2	<ul style="list-style-type: none"> <li>• Lock-error.</li> </ul>	<ul style="list-style-type: none"> <li>• Shut the door properly.</li> </ul>
E4	<ul style="list-style-type: none"> <li>• Water level not reached after 8 minutes.</li> <li>• Drain hose is self-siphoning.</li> </ul>	<ul style="list-style-type: none"> <li>• Make sure that tap is fully opened and water pressure is normal.</li> <li>• Check drain hose installation.</li> </ul>
EB	<ul style="list-style-type: none"> <li>• Water protective level-error.</li> </ul>	<ul style="list-style-type: none"> <li>• Contact the After sales service.</li> </ul>



Problem	Cause	Solution
F3	• Temperature sensor-error.	• Contact the After sales service.
F4	• Heating-error.	• Contact the After sales service.
F7	• Motor-error.	• Contact the After sales service.
F9	• Dry temperature sensor-error.	• Contact the After sales service.
FR	• Water level sensor-error.	• Contact the After sales service.
FE1 or FE2 FE3	• Abnormal communication-error.	• Contact the After sales service.
Fd	• Dry heating element-error.	• Contact the After sales service.
FE	• Dry motor-error.	• Contact the After sales service.
E12	• Drying water level is too high.	• Contact the After sales service.
Ufb	• Unbalanced load-error.	• Check and balance laundry load in the drum. Reduce the load.
Fb	• Water overflowed abnormally.	• Contact the After sales service.
E5	• Drainage error. Water is not fully drained within 1 minutes.(i-Refresh programme).	• Clean pump filter. • Check drain hose installation.

### 9.3 Troubleshooting without display code

Problem	Cause	Solution
Appliance fails to operate.	<ul style="list-style-type: none"> <li>• Programme is not yet started.</li> <li>• Door is not properly closed.</li> <li>• Machine has not been switched on.</li> <li>• Power failure.</li> <li>• Child lock is activated.</li> </ul>	<ul style="list-style-type: none"> <li>• Check programme and start it.</li> <li>• Close the door properly.</li> <li>• Switch the machine on.</li> <li>• Check power supply.</li> <li>• Deactivate child lock.</li> </ul>
Appliance will not be filled with water.	<ul style="list-style-type: none"> <li>• No water.</li> <li>• Inlet hose is kinked.</li> <li>• Inlet hose filter is blocked.</li> <li>• Water pressure is less than 0.03 MPa.</li> <li>• Door is not properly closed.</li> <li>• Water supply failure.</li> </ul>	<ul style="list-style-type: none"> <li>• Check water tap.</li> <li>• Check inlet hose.</li> <li>• Unblock inlet hose filter.</li> <li>• Check water pressure.</li> <li>• Close the door properly.</li> <li>• Ensure the water supply.</li> </ul>
Appliance is draining while being filled.	<ul style="list-style-type: none"> <li>• Height of drain hose is below 80 cm.</li> <li>• Drain hose end could reach into water.</li> </ul>	<ul style="list-style-type: none"> <li>• Make sure that drain hose is properly installed.</li> <li>• Make sure the drain hose is not in water.</li> </ul>
Drainage failure.	<ul style="list-style-type: none"> <li>• Drain hose is blocked.</li> <li>• Pump filter is blocked.</li> <li>• Drain hose end is higher than 100 cm above floor level.</li> </ul>	<ul style="list-style-type: none"> <li>• Unblock drain hose.</li> <li>• Clean pump filter.</li> <li>• Make sure that drain hose is properly installed.</li> </ul>

Problem	Cause	Solution
Strong vibration while spinning.	<ul style="list-style-type: none"> <li>Not all transportation bolts have been removed.</li> <li>Appliance has no solid position.</li> <li>Machine load is not correct.</li> </ul>	<ul style="list-style-type: none"> <li>Remove all transportation bolts.</li> <li>Ensure solid ground and a levelled position.</li> <li>Check load weight and balance..</li> </ul>
Operation stops before completing wash cycle.	<ul style="list-style-type: none"> <li>Water or electric failure.</li> </ul>	<ul style="list-style-type: none"> <li>Check power and water supply.</li> </ul>
Operation stops for a period of time.	<ul style="list-style-type: none"> <li>Appliance displays error code.</li> <li>Problem due to load pattern.</li> <li>Programme performs soaking cycle.</li> </ul>	<ul style="list-style-type: none"> <li>Consider display codes.</li> <li>Reduce or adjust load.</li> <li>Cancel programme and restart..</li> </ul>
Excessive foam floats drum and/or detergent drawer.	<ul style="list-style-type: none"> <li>Detergent is not appropriate.</li> <li>Excessive use of detergent.</li> </ul>	<ul style="list-style-type: none"> <li>Check detergent recommendations.</li> <li>Reduce amount of detergent.</li> </ul>
Automatic adjustment of washing time.	<ul style="list-style-type: none"> <li>Washing programme duration will be adjusted.</li> </ul>	<ul style="list-style-type: none"> <li>This is normal and doesn't affect functionality.</li> </ul>
Spinning fails.	<ul style="list-style-type: none"> <li>Unbalance of laundry.</li> </ul>	<ul style="list-style-type: none"> <li>Check machine load and laundry and run a spinning programme again.</li> </ul>
Unsatisfactory washing result.	<ul style="list-style-type: none"> <li>Degree of pollution does not agree with selected programme.</li> <li>Detergent quantity was not sufficient.</li> <li>Maximum load has been exceeded.</li> <li>Laundry was unevenly distributed in the drum.</li> </ul>	<ul style="list-style-type: none"> <li>Select an other programme.</li> <li>Choose the detergent acc.to the degree of pollution and acc. to manufacturer specifications.</li> <li>Reduce loading.</li> <li>Loosen the laundry.</li> </ul>
Washing powder residues are on the laundry.	<ul style="list-style-type: none"> <li>Insoluble particles of detergent can remain as white spots on the laundry.</li> </ul>	<ul style="list-style-type: none"> <li>Perform extra rinse.</li> <li>Try to brush the points from the dry laundry.</li> <li>Choose an other detergent.</li> </ul>
Laundry has grey patches.	<ul style="list-style-type: none"> <li>Caused by fats such as oils, creams or ointments.</li> </ul>	<ul style="list-style-type: none"> <li>Pretreat the laundry with a special cleaner.</li> </ul>



## Note: Foam formation

If too much foam is inspected during spin cycle, motor stops and drain pump will be activated for 90 seconds. If that elimination of foam fails up to three times, programme ends without spinning.

Should the error messages reappear even after the taken measures, switch off the appliance, disconnect the power supply and contact the customer service.

#### 9.4 In case of power failure

The current programme and its setting will be saved. When power supply is restored operation will be resumed.

If a power failure cuts an operating wash programme door opening is mechanically blocked. To get out any laundry water level should not be seen in the glassy porthole of the door. - Danger of burns! Water level has to be lowered as described in "Pump filter". Not till then pull lever (A) beneath service flap (Fig. 9-1) until door is unlocked by a gentle click. Afterwards refix all parts.

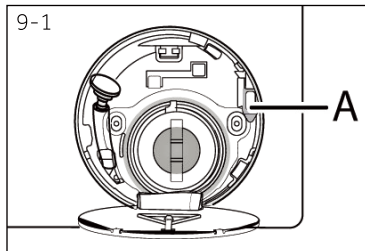

When the washing machine in a safe state (under the water level below the window along a certain distance, barrel temperature below 55 °C, the inner barrel did not turn), may unlock the doors of the machine operation.

## 10.1 Preparation

- ▶ Take the appliance out of the packaging.
- ▶ Remove all packaging material including protecting film on cabinet, polystyrene base, keep them out of childrens reach. While opening the package, water drops may be seen on plastic bag and porthole. This normal phenomenon results from water tests in the factory.



### Note: Packaging disposal

Keep all packaging materials out of children's reach and dispose them in an environmentally friendly manner.

## 10.2 OPTIONAL: Install noise reduction pads

1. When opening the shrink package, you will find four noise reduction pads. These are used for reducing noise (Fig. 10-1).
2. Lay the washing machine down to its side, porthole pointing upwards, bottom side towards operator.
3. Take out the noise reduction pads and remove the double-sided adhesive protective film; paste around the bottom; the noise reduction pads under the washing machine cabinet as shown in Figure 3. (two longer pads in position 1 and 3, two shorter pads in position 2 and 4). Finally set the machine upright again.

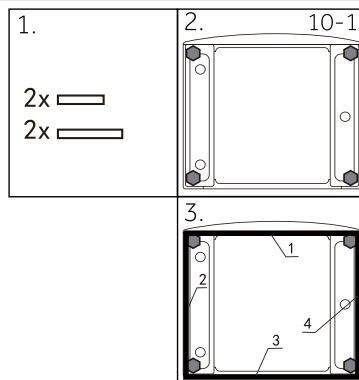

## 10.3 Dismantle the the transportation bolts

The transport protection on the rear side is designed for clamping anti-vibration components inside the appliance during transportation to prevent inner damage. All elements (I, R, S and T, Fig 10-2) must be removed before use.

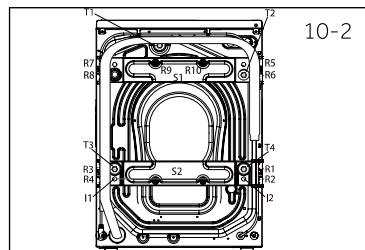

1. Remove all 4 bolts (T1 - T4) (Fig. 10-3).

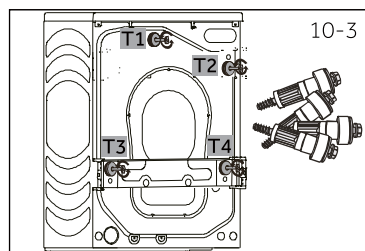

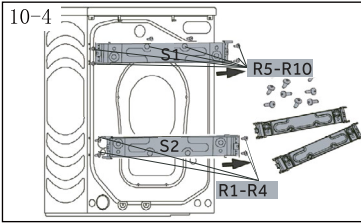

- Remove the 10 screws (R1 - R10) from lower back reinforcement, take out reinforcements (S1 and S2) from the machine. \*HWD100/120-B14979, HWD100/120-B14979S  
Remove the 4 screws (R1 - R4) from lower back reinforcement, take out reinforcements (S2) from the machine. \*HWD80-B14979, HWD80-B14979S (Fig. 10-4).

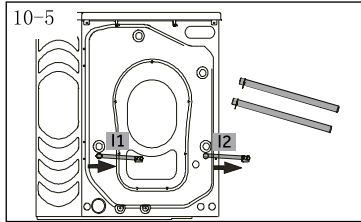

- Pull out the 2 iron bars I1 and I2 (Fig. 10-5).

- Fill the 6 left holes with blanking plugs (Fig. 10-6).

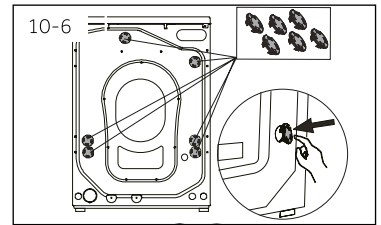

### Note: Keep in safe place

Keep all parts of the transport protection in a safe place for later use. Whenever the appliance is to be moved at first reinstall the protection parts.

## 10.4 Moving the appliance

If the machine is to be moved to a distant location, replace the transportation bolts removed before installation to prevent damage: The assembly takes place in reverse order.

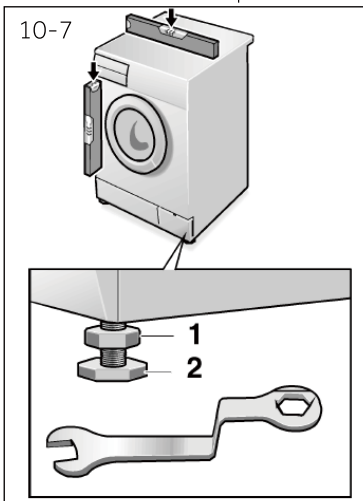

## 10.5 Aligning the appliance

Adjust all feet (Fig. 10-7) to achieve a complete level position. This will minimize vibrations and thus noise during use. It will also reduce wear and tear. We recommend to use a spirit level for adjustment. Floor should be as stable and flat as possible.

- Loose the locknut (1) by using a wrench.
- Adjust the high by turning the foot (2).
- Tighten locknut (1) against the housing.

## 10.6 Drain Water Connection

Fix the water drain hose properly to the piping. The hose has to reach at one point a height between 80 and 100 cm above the appliance bottom line! If possible keep always drain hose fixed to the clip at the appliance back.



### WARNING!

- ▶ Use only the supplied hose set for the connection.
- ▶ Never reuse old hose sets!
- ▶ Only connect to cold water supply.
- ▶ Before connection, check whether the water is clean and clear.

Following connections are possible:

#### 10.6.1 Drain hose to sink

- ▶ Hang the drain hose with the U-support over the edge of a sink with adequate size (Fig. 10-8).
- ▶ Protect the U-support sufficiently against slipping.

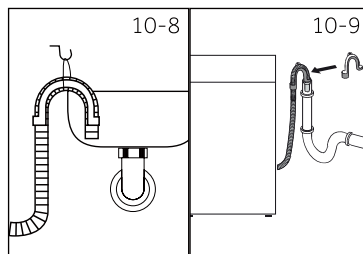

#### 10.6.2 Drain hose to waste water connection

- ▶ The internal diameter of the stand pipe with vent-hole must be minimum 40 mm.
- ▶ Put the drain hose for 80-100 mm in the wastewater pipe.
- ▶ Attach the U-support and secure it sufficiently (Fig. 10-9).

#### 10.6.3 Drain hose to sink connection

- ▶ The junction must lie above the siphon.
- ▶ A spigot connection is usually closed by a pad (A). That must be removed to prevent any disfunction (Fig. 10-10).
- ▶ Secure the drain hose with a clamp.

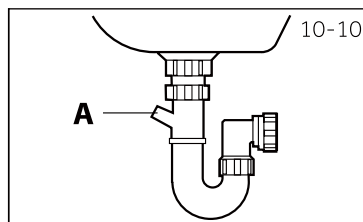

### CAUTION!

- ▶ The drain hose should not be submerged in water and should be securely fixed and leak-free. If the drain hose is placed on the ground or if the pipe is at a height of less than 80 cm, the washing machine will continuously drain while being filled (self-siphoning).
- ▶ Drain hose is not to be extended. If necessary contact after sales service.

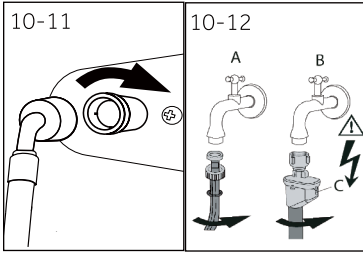

### 10.7 Fresh Water Connection

Make sure that the gaskets are inserted.

1. Connect the water inlet hose with the angled end to the appliance (Fig. 10-11). Tighten the screw joint by hand.
2. The other end connect to a water tap with a 3/4" thread (Fig. 10-12).

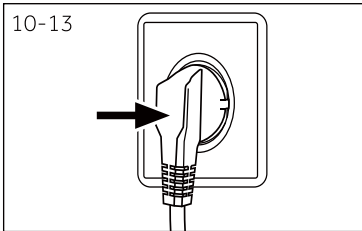

### 10.8 Electrical Connection

Before each connection check if:

- ▶ power supply, socket and fusing are appropriate to the rating plate.
- ▶ the power socket is earthed and no multi-plug or extension are used.
- ▶ the power plug and socket are strictly according.
- ▶ **Only UK:** The UK plug meets BS1363A standard.

Put the plug into the socket (Fig. 10-13).



### WARNING!

- ▶ Ensure always that all connections (power supply, drain and fresh water hose) are firm, dry and leak free!
- ▶ Take care these parts are never to be crushed, kinked, or twisted.
- ▶ If the supply cord is damaged, it must be replaced by the service agent (see warranty card) in order to avoid a hazard.

## 11.1 Product fiche according to regulation EU No. 1061/2010

Trade mark	Haier		
Model identifier	HWD80-B14979 HWD80-B14979S	HWD100-B14979 HWD100-B14979S	HWD120-B14979 HWD120-B14979S
Energy efficiency class <sup>1)</sup>	A	A	A
Energy consumption for washing, spinning and drying using the standard cotton programmes <sup>2)</sup> in kW-h/complete operating cycle. <sup>3)</sup>	5.43	6.8	7.9
Energy consumption for washing, spinning using the standard cotton washing programmes <sup>2)</sup> in kW-h/washing cycle. <sup>3)</sup>	0.91	0.9	1.15
Washing performance class <sup>1)</sup>	A	A	A
Water remaining after spin for standard 60 C cotton washing cycle <sup>2)</sup> in %	46	52	43
Maximum spin speed for standard 60 C cotton washing cycle <sup>2)</sup> in prm	1370	1390	1400
Washing capacity for standard 60 C cotton washing cycle (without drying) <sup>2)</sup> in kg.	8	10	12
Drying capacity for standard "dry cotton" drying cycle <sup>2)</sup> in kg.	5	6	8
Water consumption for washing, spinning and drying <sup>2)</sup> in L/complete operating cycle.	100	114	122
Water consumption for washing, spinning only <sup>2)</sup> in L/complete operating cycle.	57	62	65
Washing and drying time. Programme time for complete operating cycle in min.	675	715	685
Estimated annual consumption for a four-person household, always using the drier (200 cycles) in kW-h.	1086	1360	1580
Estimated annual consumption for a four-person household, never using the drier (200 cycles) in kW-h.	182	180	230
Noise during washing, spinning and drying cycles using the standard cotton programme <sup>2)</sup> in dB(A) re 1pW	55/73/63	55/72/61	53/72/59

<sup>1)</sup> Class G is the least efficient and Class A is the most efficient.

<sup>2)</sup> Enter the European standard test procedure :

Washing: Select Eco 40-60, often touch speed for 5 seconds. After the temperature function is displayed, select the temperature and the maximum speed, touch Start button.

Drying: Select Eco 40-60, often touch speed for 5 seconds. After the temperature function is displayed, select Dry programme, often touch Dry Level for 5 seconds, then display "dr", touch Start button.

<sup>3)</sup> Actual energy consumption per cycle will depend on how the appliance is used.



### 11.2 Additional technical data

	HWD80-B14979 HWD80-B14979S	HWD100-B14979 HWD100-B14979S	HWD120-B14979 HWD120-B14979S
Dimension (HxDxW in mm)	850x460x595	850x530x595	850x600x595
Voltage in V	220-240 V~/50Hz		
Current in A	10		
Max. power in W	2000		
Water pressure in MPa	0.03≤P ≤1		
Netto weight in kg	75	81	85

### 11.3 Standards and Directives

This product meets the requirements of all applicable EC directives with the corresponding harmonised standards, which provide for CE marking.

We recommend our Haier Customer Service and the use of original spare parts.

- ▶ your local dealer.
- ▶ and FAQs and where you can activate the service claim.

To contact our Service, ensure that you have the following data available.  
The information can be found on the rating plate.

Model \_\_\_\_\_ Serial No. \_\_\_\_\_

Also check the Warranty Card supplied with the product in case of warranty.

European Haier addresses			
Country*	Postal address	Country*	Postal address
Italy	Haier Europe Trading SRL Via De Cristoforis, 12 21100 Varese ITALY	France	Haier France SAS 3-5 rue des Gravieres 92200 Neuilly sur Seine FRANCE
Spain Portugal	Haier Iberia SL Calle Marruecos 200, 08019, Barcelona SPAIN	Belgium-FR Belgium-NL Netherlands Luxembourg	Haier Benelux SA Anderlecht Route de Lennik 451 BELGIUM
Germany Austria	Haier Deutschland GmbH Hewlett-Packard-Str. 4 D-61352 Bad Homburg GERMANY	Poland Czechia Hungary Greece Romania Russia	Haier Poland Sp. zo.o. Al. Jerozolimskie 181B 02-222 Warszawa POLAND
United Kingdom	Haier Appliances UK Co.Ltd. One Crown Square Church Street East Woking, Surrey, GU21 6HR UK		

\*For more information please refer to [www.haier.com](http://www.haier.com)





**Haier**