

# OLYMPUS

## DIGITAL CAMERA E-M10 Mark IV Instruction Manual

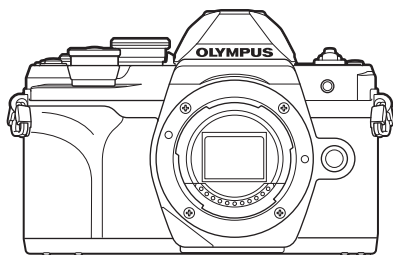

### Table of Contents

#### Feature Index

1. Preparation
2. Shooting
3. Playback
4. Menu functions
5. Connecting the camera to a smartphone
6. Connecting the camera to a computer
7. Cautions
8. Information
9. SAFETY PRECAUTIONS

Model No.: IM021

- Thank you for purchasing an Olympus digital camera. Before you start to use your new camera, please read these instructions carefully to enjoy optimum performance and a longer service life.
- Be sure you have read and understood the contents of "9. SAFETY PRECAUTIONS", before using this product. Keep these instructions available for future reference.
- We recommend that you take test shots to get accustomed to your camera before taking important photographs.
- The screen and camera illustrations shown in this manual were produced during the development stages and may differ from the actual product.
- If there are additions and/or modifications of functions due to firmware update for the camera, the contents will differ. For the latest information, please visit the Olympus website.

# Before You Begin

## **Read and Follow Safety Precautions**

To prevent incorrect operation resulting in fire or other damage to property or harm to yourself or to others, read "9. SAFETY PRECAUTIONS" (P. 176) in its entirety before using the camera.

While using the camera, consult this manual to ensure safe and correct operation. Be sure to keep the manual in a safe place once it is read.

Olympus will not be held liable for violations of local regulations arising from use of this product outside the country or region of purchase.

## **Wireless LAN and Bluetooth®**

The camera features built-in wireless LAN and **Bluetooth®**. Use of these features outside the country or region of purchase may violate local wireless regulations; be sure to check with local authorities before use. Olympus will not be held liable for the user's failure to comply with local regulations.

Disable wireless LAN and **Bluetooth®** in areas where their use is prohibited.

 "Disabling wireless LAN/Bluetooth®" (P. 150)

## **■ User Registration**

Visit the OLYMPUS website for information on registering your OLYMPUS products.

## **■ Installing PC Software/Apps**

### **Olympus Workspace**

This computer application is used to download and view photos and movies recorded with the camera. It can also be used to update the camera firmware. The software can be downloaded from the website below. Be prepared to provide the camera serial number when downloading the software.

<https://support.olympus-imaging.com/owdownload/>

### **OLYMPUS Image Share (OI.Share)**

You can load images in the camera to a smartphone.

You can also operate the camera remotely and take pictures from a smartphone.

<https://app.olympus-imaging.com/oishare/>



In addition to the “Instruction Manual”, we also offer a “Camera Function Guide”. Consult these manuals when using the product.

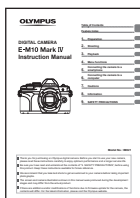

## Instruction Manual (this pdf)

A how-to guide to the camera and its features. The Instruction Manual can be downloaded from the OLYMPUS website or directly using the “OLYMPUS Image Share” (OI.Share) smartphone app.



## Camera Function Guide

A function and setting guide that helps you use camera features to the full. It has been optimized for display on mobile devices and can be viewed using OI.Share.  
<https://cs.olympus-imaging.jp/jp/support/cs/webmanual/index.html>





## Indications used in this manual

The following symbols are used throughout this manual.

	Notes and other supplementary information.
	Tips and other helpful information for using the camera.
	References to other pages in this manual.

# Table of Contents

<b>Before You Begin</b>	<b>2</b>	<b>Shooting with touch screen operations</b> .....32
<b>Product Manuals</b>	<b>3</b>	<b>Switching Displays with the  (Shortcut) Button</b> .....33
<b>Feature Index</b>	<b>9</b>	<b>Letting the camera choose the settings (AUTO mode)</b> .....34
<b>Names of parts</b>	<b>11</b>	<b>Shooting in scene mode (SCN mode)</b> .....36
<b>Preparation</b>	<b>13</b>	Types of scene modes.....36
<b>Unpacking the box contents</b> .....13		<b>Shooting in advanced photo mode ( mode)</b> .....40
<b>Attaching the Strap</b> .....14		AP Mode Options .....40
<b>Inserting and Removing the Battery and Card</b> .....15		[Live Composite]: Live Composite Photography .....41
Removing the battery .....16		[Live Time]: Live Time Photography .....42
Removing the card .....16		[Multiple Exposure]: Shooting Multiple Exposures .....43
<b>Charging the Battery</b> .....17		[HDR]: Taking Composite Photos with HDR .....44
<b>Attaching a lens to the camera</b> .....19		[Silent  ] Mode.....45
<b>Removing Lenses</b> .....20		Shooting a Panorama.....46
<b>Turning the camera on</b> .....21		[Keystone Compensation] .....47
<b>Initial setup</b> .....22		[AE Bracketing]: Varying Exposure over a Series of Shots .....48
<b>Camera displays unreadable/not in the selected language</b> .....24		[Focus Bracketing]: Varying Focus Distance over a Series of Shots .....49
<b>Shooting</b>	<b>25</b>	<b>Using art filters (ART mode)</b> .....50
<b>Switching between displays</b> .....25		Types of art filters .....52
<b>Information displays while shooting</b> .....26		Adjusting the degree of the art filter effect (Fine-Tuning).....53
Switching the information display .....28		Using [Partial Color].....53
<b>Choosing a shooting mode and taking photos</b> .....29		<b>Letting the camera choose aperture and shutter speed (Program mode)</b> .....54
Types of shooting modes.....29		<b>Choosing aperture (Aperture Priority mode)</b> .....56
<b>Taking high angle and low angle shots</b> .....31		



■ <b>Choosing shutter speed (Shutter Priority mode)</b> .....	58	Adjusting color (WB (white balance)).....	83
■ <b>Choosing aperture and shutter speed (Manual mode)</b> .....	60	Choosing a focus mode (AF Mode).....	84
■ <b>Shooting with long exposure time (BULB/LIVE TIME)</b> .....	61	Setting the image aspect.....	86
■ <b>Live composite photography (dark and light field composite)</b> .....	63	Selecting image quality (Still image quality, .....	86
■ <b>Recording movies in photo shooting modes</b> .....	65	Selecting image quality (Movie quality, .....	87
■ <b>Recording movies in movie mode</b> .....	66	Choosing an Exposure Mode (Mode (Movie Exposure Modes)) .....	91
Movie Mode Options.....	67	Adjusting flash output (Flash intensity control) .....	92
■ <b>Recording Slow Motion Movies</b> .....	68	Reducing camera shake (Image Stabilizer) .....	93
■ <b>Silencing Camera Sounds While Shooting Movies</b> .....	68	Making fine adjustments to white balance (WB Compensation)....	94
■ <b>Taking Photos in Self-Portrait Mode</b> .....	69	Choosing how the camera measures brightness (Metering) .....	95
■ <b>Using various settings</b> .....	71	Making fine adjustments to sharpness (Sharpness) .....	95
Controlling exposure (Exposure  ).....	71	Making fine adjustments to contrast (Contrast).....	96
Digital Zoom (Digital Tele-converter) .....	71	Making fine adjustments to saturation (Saturation).....	96
Selecting the AF target mode (AF target settings).....	72	Making fine adjustments to tone (Gradation) .....	97
Setting the AF target.....	72	Applying filter effects to monochrome pictures (Color Filter).....	97
Face priority AF/Eye priority AF .....	73	Adjusting the tone of a monochrome image (Monochrome Color).....	98
Changing ISO sensitivity (ISO).....	74	Adjusting i-Enhance effects (Effect).....	98
Using a flash (Flash photography) .....	75	Setting the color reproduction format (Color Space) .....	99
Performing the sequential/self-timer shooting .....	77	Changing the brightness of highlights and shadows (Highlight&Shadow Control) ...	100
The Electronic Shutter (Silent []) .....	78	Assigning functions to buttons (Button Function).....	101
Calling shooting options .....	79		
Processing options (Picture Mode).....	81		
Adjusting overall color (Color Creator).....	82		

Zoom frame AF/Zoom AF  
(Super Spot AF)..... 103









## Playback 105

- **Information display during playback** ..... 105
  - Playback image information ... 105
  - Switching the information display ..... 106
- **Viewing photographs and movies** ..... 107
  - Finding Pictures Quickly (Index and Calendar Playback) ..... 108
  - Zooming In (Playback Zoom) ..... 108
  - Rotating Pictures (Rotate) ..... 108
  - Viewing Images as a Slideshow (🖼️) ..... 109
  - Watching movies ..... 110
  - Protecting Pictures (🔒) ..... 110
  - Deleting Pictures (Erase)..... 110
  - Selecting Pictures for Sharing (Share Order) ..... 111
  - Cancelling all share orders (Reset share Order)..... 111
  - Selecting Multiple Pictures (🔍, Erase Selected, Share Order Selected) ..... 111
  - Creating a print order (DPOF) ..... 112
  - Removing all or selected pictures from the print order ..... 113
  - Adding Audio to Pictures (🎧) ..... 113
  - Audio Playback (Play 🎵) ..... 113
  - Scrolling Panoramas ..... 114
- **Using the touch screen**..... 115
  - Single-frame playback ..... 115
  - Index/Calendar playback ..... 115
  - Selecting and protecting images ..... 116

Viewing pictures in self-portrait mode..... 116

## Menu functions 117

- **Basic menu operations**..... 117
- **Using Shooting Menu 1/ Shooting Menu 2** ..... 118
  - Returning to default settings (Reset)..... 118
  - Processing options (Picture Mode)..... 119
  - Digital Zoom (Digital Tele-converter) ..... 119
  - Improving Focus in Dark Surroundings (AF Illuminator)..... 119
  - Choosing a Zoom Speed (📷 Elec. Zoom Speed) ..... 120
  - Recording multiple exposures in a single image (Multiple Exposure)..... 120
  - Shooting automatically with a fixed interval (Intrvl. Sh./Time Lapse) ..... 122
  - Silent-Mode Options (Silent [♥] Settings) ..... 123
  - Wireless remote control flash photography (⚡ RC Mode) ..... 124
- **Using the Video Menu**..... 125
- **Using the Playback Menu** ..... 126
  - Automatically Rotating Portrait-Orientation Pictures for Playback (📷) ..... 126
  - Retouching Pictures (Edit)..... 126
  - Combining Pictures (Image Overlay)..... 128
  - Creating Movie Stills (In-Movie Image Capture)..... 128
  - Trimming movies (Movie Trimming)..... 129
  - Removing Protection from All Pictures (Reset Protect) ..... 129















Using the setup menu.....	130
Formatting the card (Card Setup).....	131
Deleting all images (Card Setup).....	131
Choosing a language (  ).....	131
Using the custom menus.....	132
<b>A</b> AF/MF.....	132
<b>B</b> Button/Dial.....	132
<b>C1</b> Disp/  /PC.....	133
<b>C2</b> Disp/  /PC.....	133
<b>D1</b> Exp/ISO/BULB.....	134
<b>D2</b> Exp/ISO/BULB.....	134
<b>E</b>  Custom.....	135
<b>F</b>  /WB/Color.....	135
<b>G</b> Record.....	136
<b>H</b> EVF.....	137
<b>I</b>  Utility.....	137
AEL/AFL.....	138
Manual Focus Assist (MF Assist).....	138
Adding information displays....	139
Viewing camera images on TV (HDMI).....	140
Shutter speeds when the flash fires (  X-Sync./  Slow Limit).....	141
Combinations of JPEG image sizes and compression rates (  Set).....	141
<b>Connecting the camera to a smartphone</b> 142	
Pairing the Camera and Smartphone.....	143
Wireless Connection Standby Setting for When the Camera Is On.....	144
Wireless Settings for When the Camera Is Off.....	145
Transferring images to a smartphone.....	147
Automatically uploading images while the camera is off.....	147
Shooting remotely with a smartphone (Live View).....	148
Shooting remotely with a smartphone (Remote Shutter).....	148
Adding position information to images.....	149
Resetting wireless LAN/ Bluetooth® settings.....	149
Changing the password.....	150
Disabling wireless LAN/ Bluetooth®.....	150
<b>Connecting the camera to a computer</b> 151	
Copying pictures to a computer.....	151
Installing the PC software.....	152
<b>Cautions</b> 153	
Batteries.....	153
Using your USB-AC adapter abroad.....	153
Usable cards.....	154
Record mode and file size/number of storable still pictures.....	154
Interchangeable lenses.....	155
MF Clutch Lenses.....	156
Compatible Flash Units.....	157
Wireless remote control flash photography.....	158
Other external flash units.....	159
System chart.....	160

<b>Information</b>	<b>162</b>
■ <b>Cleaning and storing the camera</b> .....	<b>162</b>
Cleaning the camera .....	162
Storage .....	162
Cleaning and checking the image pickup device .....	162
Pixel Mapping - Checking the image processing functions ....	163
■ <b>Shooting tips and information</b>	<b>164</b>
■ <b>Error codes</b> .....	<b>167</b>
■ <b>Defaults</b> .....	<b>169</b>
■ <b>Specifications</b> .....	<b>173</b>
<b>SAFETY PRECAUTIONS</b>	<b>176</b>
■ <b>SAFETY PRECAUTIONS</b> .....	<b>176</b>
<b>Index</b>	<b>181</b>

# Feature Index

Feature	
Shooting Mode	29
Monitor Display	28, 106
Live Controls	79
LV Super Control Panel	80
<b>📷 Shooting Menu 1</b>	
Reset	118
Picture Mode	81, 119
Digital Tele-converter	119
Metering	95
AF Illuminator	119
<b>📷 Shooting Menu 2</b>	
Image Stabilizer	93
Elec. Zoom Speed	120
Multiple Exposure	92
Multiple Exposure	120
Intrvl. Sh./Time Lapse	122
Silent [♥] Settings	123
RC Mode	124
<b>📺 Video Menu</b>	
Movie	125
Recording Volume	125
AF Mode	125
Image Stabilizer	93
Elec. Zoom Speed	125
Video Frame Rate	87, 125
Video Bit Rate	87, 125
<b>▶ Playback Menu</b>	
	109
	126
Edit	126
Print Order	112
Reset Protect	129
Reset share Order	111
Device Connection	143

Feature	
<b>⚙️ Custom Menu</b>	
<b>A AF/MF</b>	
AEL/AFL	132, 138
AF Targeting Pad	132
Face Priority	73, 132
MF Assist	132, 138
Reset Lens	132
<b>B Button/Dial</b>	
Button Function	101, 132
Function	132
Dial Function	132
<b>C1 Disp./)/PC</b>	
Control Settings	80, 133
Info Settings	133, 139
Live View Boost	133
Flicker Reduction	133
Displayed Grid	133
Peaking Color	133
<b>C2 Disp./)/PC</b>	
	133
HDMI	133, 140
USB Mode	133
<b>D1 Exp/ISO/BULB</b>	
Exposure Shift	134
ISO-Auto Set	134
Noise Filter	134
Noise Reduct.	62, 134
<b>D2 Exp/ISO/BULB</b>	
Bulb/Time Timer	61, 134
Live Bulb	61, 134
Live Time	61, 134
Composite Settings	63, 134

Feature	
<b>E</b>  Custom	
 X-Sync.	135, 141
 Slow Limit	135, 141
  + 	71, 92, 135
 +WB	135
<b>F</b>  /WB/Color	
 Set	135, 141
WB	83, 135
 <small>WB AUTO</small> Keep Warm Color	135
Color Space	99, 135
<b>G</b> Record	
File Name	136
Edit Filename	136
Copyright Settings	136
<b>H</b> EVF	
EVF Auto Switch	137
EVF Adjust	137
<b>I</b>  Utility	
Pixel Mapping	137, 163
Level Adjust	137
Touchscreen Settings	137
Sleep	21, 137
Certification	137
<b>Y</b> Setup Menu	
Card Setup	131
	23
	130, 131
	130
Rec View	130
Wi-Fi/Bluetooth Settings	150
Firmware	130

# Names of parts

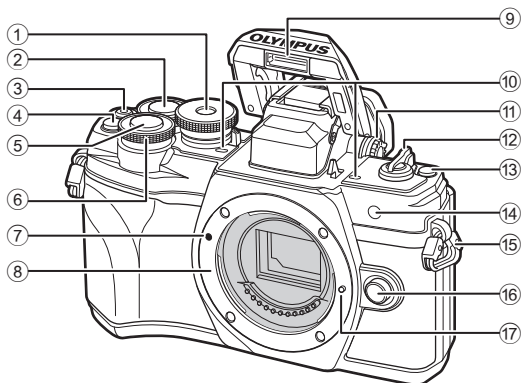

- |   |   |
|---|---|
| ① Mode dial .....P. 29                                      | ⑨ Built-in flash .....P. 75                           |
| ② Rear dial* (☺) ..... P. 54-60, 107                        | ⑩ Stereo microphone .....P. 113, 125, 127             |
| ③ (Movie)/ button ..... P. 65/P. 111                        | ⑪ Diopter adjustment dial .....P. 25                  |
| ④ (Digital Tele-converter) button<br>.....P. 71, 101        | ⑫ <b>ON/OFF</b> lever .....P. 21                      |
| ⑤ Shutter button .....P. 30                                 | ⑬ (Shortcut) button .....P. 33                        |
| ⑥ Front dial* (☺).....P. 54-60, 71, 75, 107                 | ⑭ Self-timer lamp/AF illuminator<br>.....P. 77/P. 119 |
| ⑦ Lens attachment mark .....P. 19                           | ⑮ Strap eyelet.....P. 14                              |
| ⑧ Mount (Remove the body cap before<br>attaching the lens.) | ⑯ Lens release button .....P. 20                      |
|   | ⑰ Lens lock pin                                       |

\* In this manual, the ☺ and ☹ icons represent operations performed using the front dial and rear dial.

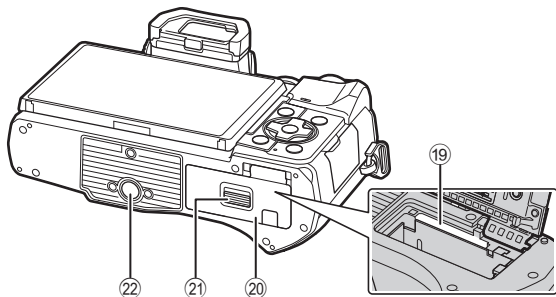
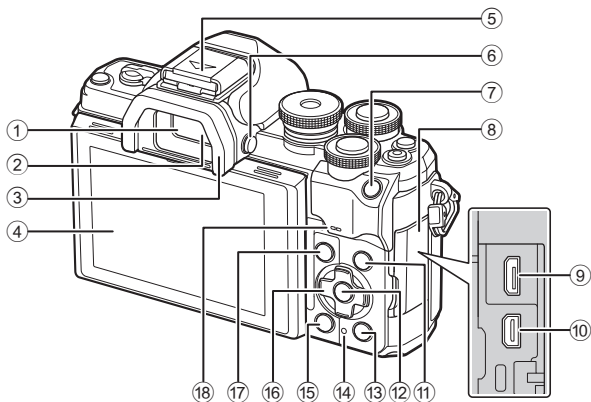

- |  |  |
|--|--|
| ① Viewfinder .....P. 25                                  | ⑬  (Playback) button.....P. 107                    |
| ② Eye sensor.....P. 25                                   | ⑭ <b>CHARGE</b> (battery charge) lamp...P. 17      |
| ③ Eyecup.....P. 159                                      | ⑮  (Erase) button .....P. 110                      |
| ④ Monitor (Touch screen)<br>.....P. 26, 32, 79, 105, 115 | ⑯ Arrow pad*.....P. 22, 72–77, 107                 |
| ⑤ Hot shoe (Hot shoe cover).....P. 157                   | ⑰ <b>MENU</b> button.....P. 117                    |
| ⑥  (LV) button.....P. 25                                 | ⑱ Speaker  |
| ⑦ <b>AEL/AFL</b> button .....P. 101, 102, 138            | ⑲ Card slot .....P. 16                             |
| ⑧ Connector cover  | ⑳ Battery/card compartment cover<br>.....P. 15, 16 |
| ⑨ Micro-USB connector.....P. 151                         | ㉑ Battery/card compartment lock<br>.....P. 15, 16  |
| ⑩ HDMI micro connector .....P. 140                       | ㉒ Tripod socket                                    |
| ⑪ <b>INFO</b> button.....P. 28, 106, 139                 |  |
| ⑫  button .....P. 79, 107                                |  |

\* In this manual, the icons represent operations performed using the arrow pad.



## Unpacking the box contents

At purchase, the package contains the camera and the following accessories.  
If anything is missing or damaged, contact the dealer from whom you purchased the camera.



Camera



Body cap\*



EP-15 eyecup\*

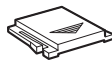

Hot shoe cover\*

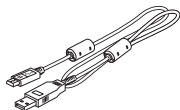
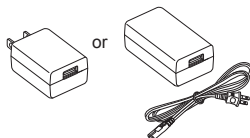

Strap

USB cable  
CB-USB12Lithium-ion battery  
BLS-50

USB-AC adapter F-5AC

Basic Manual

Warranty Card

\* The body cap, eyecup, and hot shoe cover attached to or inserted in the camera.

## Attaching the Strap

1

Preparation

- 1 Before attaching the strap, remove the end from the keeper loop and loosen the strap as shown.

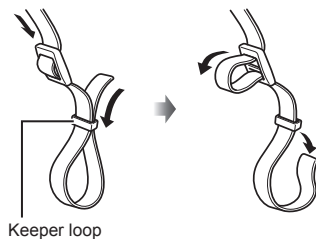

- 2 Pass the end of the strap through the strap eyelet and back through the keeper loop.

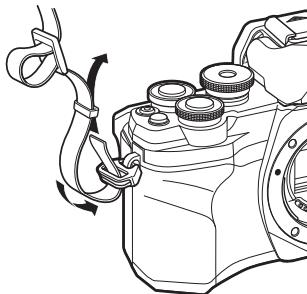

- 3 Pass the end of the strap through the buckle and tighten as shown.

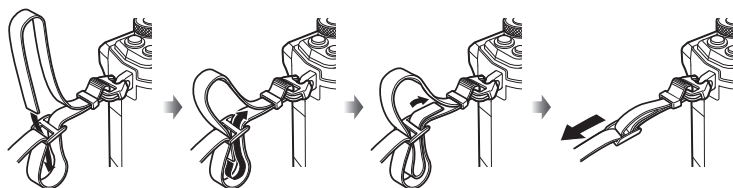

- Attach the other end of the strap to the other eyelet.
- After attaching the strap, pull on it firmly to ensure that it will not come loose.

## Inserting and Removing the Battery and Card

In this manual, all storage devices are referred to as “cards.”

The camera uses third-party SD, SDHC, or SDXC memory cards conforming to the SD (Secure Digital) standard.

Cards must be formatted with this camera before first use or after being used with other cameras or computers.  “Formatting the card (Card Setup)” (P. 131)

- 1 Confirm that the **ON/OFF** lever is in the **OFF** position.

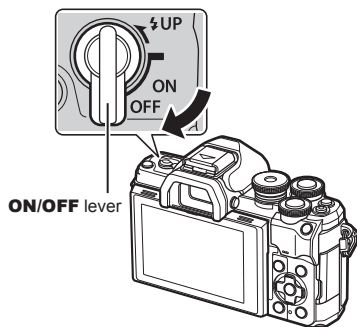

- 2 Opening the battery/card compartment cover.

Battery/card compartment cover

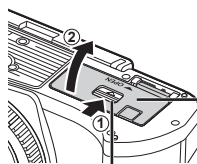

Battery/card compartment lock

- 3 Loading the battery.
  - Use only BLS-50 batteries (P. 13, 175).

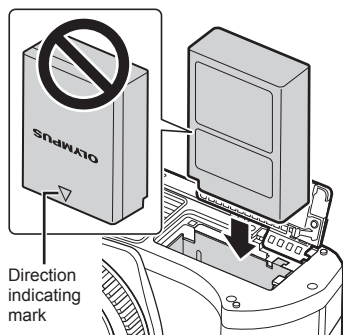

#### 4 Loading the card.

- Slide the card in until it is locked into place.  
 "Usable cards" (P. 154)

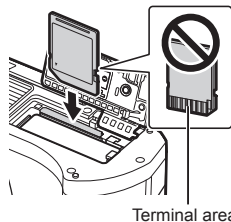

Terminal area

- Do not forcibly insert a damaged or deformed card. Doing so may damage the card slot.

#### 5 Closing the battery/card compartment cover.

- Be sure the battery/card compartment cover is closed before using the camera.

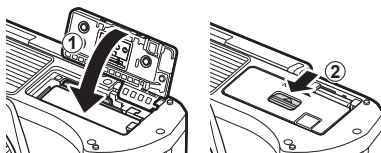

- It is recommended to set aside a backup battery for prolonged shooting in case the battery in use drains.
- Also read "Batteries" (P. 153).

### Removing the battery

Turn off the camera before opening or closing the battery/card compartment cover. To remove the battery, first push the battery lock knob in the direction of the arrow and then remove.

- Do not remove the battery while the card write indicator is displayed (P. 26, 27).
- Contact an authorized distributor or service center if you are unable to remove the battery. Do not use force.

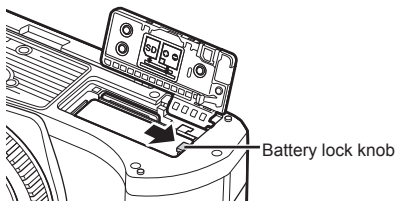

Battery lock knob

### Removing the card

Press the inserted card lightly and it will be ejected. Pull out the card.

- Do not remove the card while the card write indicator is displayed (P. 27).

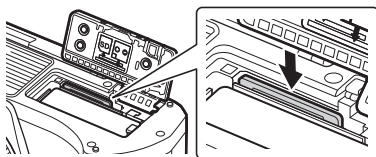

## Charging the Battery

- 1 Confirm that the **ON/OFF** lever is in the **OFF** position.

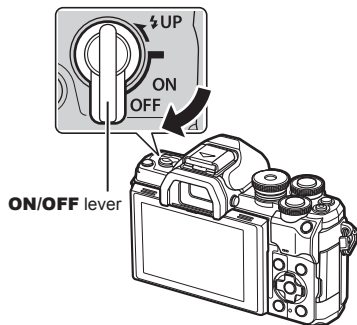

- 2 Check that the battery is in the camera, and connect the USB cable and USB-AC adapter.

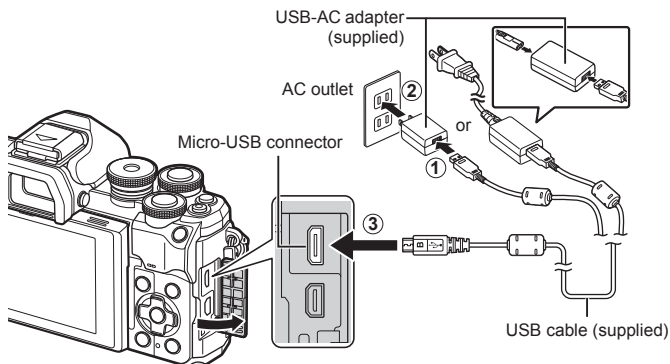

- Never use any cable other than supplied or Olympus-designated USB cable. This may cause smoking or burning.
- The **CHARGE** lamp light during charging. Charging takes about 4 hours. The lamp goes out as the batteries reach full charge.
- Even if charging is in progress, it stops when the camera is turned on.

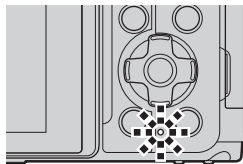

- The USB-AC adapter cannot be used to charge the batteries when the camera is on.
- If a charging error occurs, the **CHARGE** lamp will blink. Disconnect and reconnect the USB cable.
- USB charging is available when the battery temperature is between 0 and 40 °C (32 and 104 °F).

- A charger (BCS-5: sold separately) can be used to charge the battery.



- For safety reasons, charging may take longer, or the battery may not reach full charge, when the battery is charged in a high-temperature environment.
- The batteries will not charge while the camera is off if pictures are being uploaded to a smartphone via Wi-Fi (background auto upload).  "Automatically uploading images while the camera is off" (P. 147)



### **The USB-AC Adapter**

- Be sure to unplug the USB-AC adapter for cleaning. Leaving the USB-AC adapter plugged in during cleaning could result in injury or electric shock.

## Attaching a lens to the camera

- 1 Confirm that the **ON/OFF** lever is in the **OFF** position.

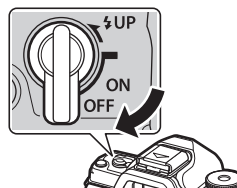

- 2 Remove the rear cap of the lens and the body cap of the camera.

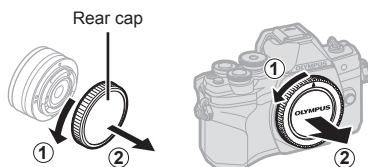

- 3 Align the lens attachment mark (red) on the camera with the alignment mark (red) on the lens, then insert the lens into the camera's body.

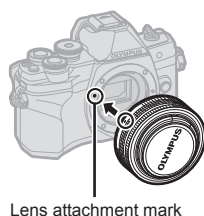

- 4 Rotate the lens as shown until it clicks into place.



- Do not press the lens release button.
- Do not touch internal portions of the camera.

- 5 Remove the front lens cap.

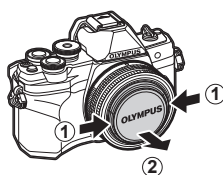
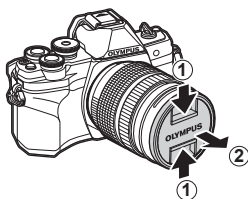

## Removing Lenses

- 1 Confirm that the **ON/OFF** lever is in the **OFF** position.
- 2 Hold the lens release button and rotate the lens as shown.

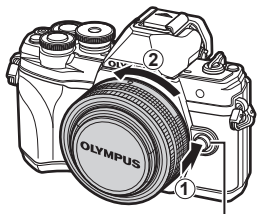
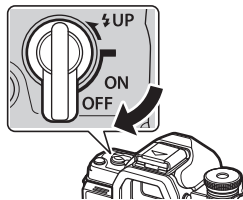

Lens release button

### Interchangeable lenses

Read "Interchangeable lenses" (P. 155).



## Turning the camera on

### 1 Set the **ON/OFF** lever to the **ON** position.

- When the camera is turned on, the monitor will turn on.
- To turn the camera off, return the lever to the **OFF** position.

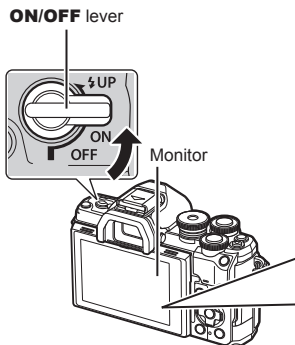

### Battery level

The battery level icon will be displayed.

- ■ ■ ■ (green): The camera is ready to shoot.
- ■ ■ (green): The battery is not full.
- ■ (green): The battery is low.
- (blinks red): Charge the battery.



### Camera sleep operation

If no operations are performed for a minute, the camera enters “sleep” (stand-by) mode to turn off the monitor and to cancel all actions. Pressing the shutter button reactivates the camera. The camera will turn off automatically if left in sleep mode for 4 hours. Turn the camera on again before use. You can choose how long the camera remains idle before entering sleep mode.  [Sleep] (P. 137)

## Initial setup

After turning the camera on for the first time, perform the initial setup by choosing a language and setting the camera clock.

- Date and time information is recorded on the card together with the images.
- The file name is also included with the date and time information. Be sure to set the correct date and time before using the camera. Some functions cannot be used if the date and time have not been set.

1 Press the **OK** button when the initial setup dialog is displaying prompting you to choose a language.

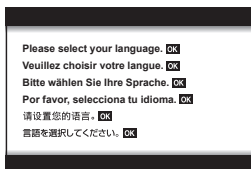

2 Highlight the desired language using the front or rear dial or the **△ ▽ ◀ ▶** buttons on the arrow pad.

- The language-selection dialog has two pages of options. Use the front or rear dial or the **△ ▽ ◀ ▶** buttons on the arrow pad to move the cursor between pages.

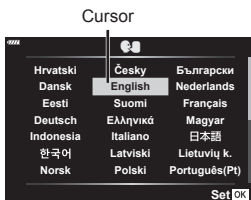

3 Press the **OK** button when the desired language is highlighted.

- If you press the shutter button before pressing the **OK** button, the camera will exit to shooting mode and no language will be selected. You can perform the initial setup by turning the camera off and then on again to display the initial setup dialog and repeating the process from Step 1.
- The language can be changed at any time from the **↓** setup menu. **↓** “Choosing a language ( **☺** )” (P. 131)



#### 4 Set the date, time, and date format.

- Use the ◀▶ buttons on the arrow pad to highlight items.
- Use the ▲▼ buttons on the arrow pad to change the highlighted item.
- The clock can be adjusted at any time from the ⌚ setup menu. ⌚ [⌚] (P. 130)

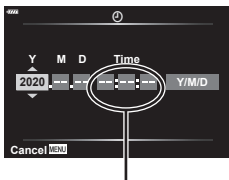

The time is displayed using a 24-hour clock.

#### 5 Complete the initial setup.

- Press the **OK** button to set the clock.
- If the battery is removed from the camera and the camera is left for a while, the date and time may be reset to the factory default setting.
- If you are going to record movies, adjust the frame rate according to the video standard of the country/region. ⌚ [Video Frame Rate] (P. 125)

#### Turning the camera off

To turn the camera off, return the **ON/OFF** lever to the **OFF** position. See page 145 for information on how to proceed if the camera displays the dialog shown in the illustration.

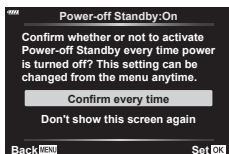
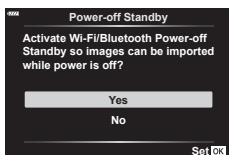

## Camera displays unreadable/not in the selected language

If the camera displays are in an unfamiliar language or use characters you are unable to read, you may have accidentally selected the wrong language in the language-selection dialog. Follow the steps below to change languages.

1

Preparation

- 1 Press the **MENU** button to display the menus.
- 2 Highlight the **?** tab using  $\Delta$   $\nabla$  and press  $\blacktriangleright$ .

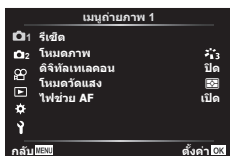

- 3 Highlight the **[?]** using  $\Delta$   $\nabla$  and press  $\blacktriangleright$ .
- 4 Highlight the desired language using  $\Delta$   $\nabla$   $\blacktriangleleft$  and press the **OK** button.

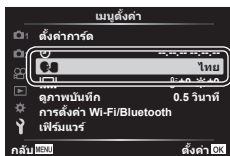

# 2 Shooting

## Switching between displays

The camera is equipped with an eye sensor, which turns the viewfinder on when you put your eye to the viewfinder. When you take your eye away, the sensor turns the viewfinder off and turns the monitor on.

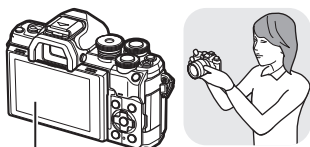

Monitor



View through lens shown in monitor

Put your  
eye to the  
viewfinder

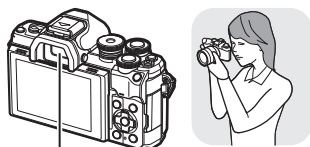

Viewfinder



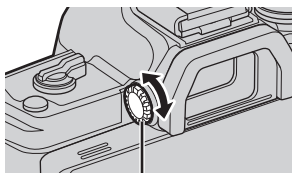

View through lens shown in viewfinder

- If the viewfinder is not in focus, put your eye to the viewfinder and focus the display by rotating the diopter adjustment dial.



Diopter adjustment dial

- You can display the EVF Auto Switch setting menu if you press and hold the  [EVF Auto Switch] (P. 137)
- When [Off] is selected for [EVF Auto Switch], you can switch displays by pressing the  button.

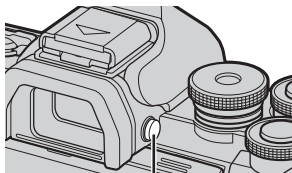

 button



- Tilting the monitor disables the eye sensor.

## Information displays while shooting

### Monitor display during still photography

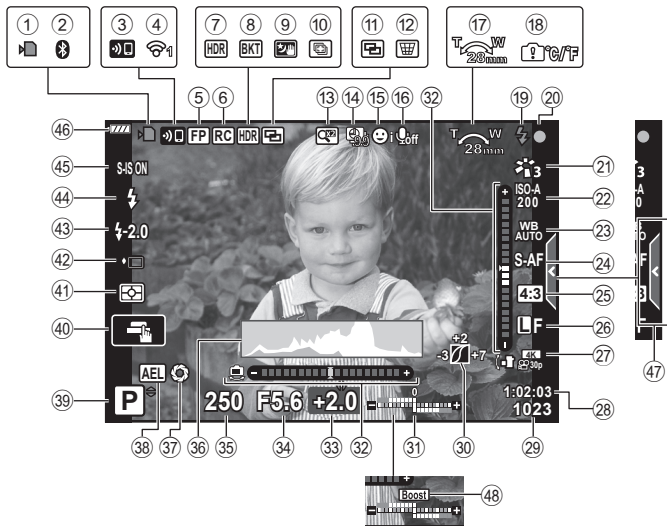

### Monitor display during movie mode





- ① Card write indicator.....P. 16
- ② **Bluetooth**® connection status  
.....P. 142–150
- ③ Wireless LAN connection starting up  
.....P. 142–150
- ④ Wireless LAN connection status  
.....P. 142–150
- ⑤ Super FP flash.....P. 157
- ⑥ RC mode.....P. 157
- ⑦ HDR.....P. 44
- ⑧ AE Bracketing.....P. 48  
Focus Bracketing.....P. 49
- ⑨ Handheld Starlight.....P. 37
- ⑩ Multi Focus Shot.....P. 39
- ⑪ Multiple exposure.....P. 43, 120
- ⑫ Keystone compensation.....P. 47
- ⑬ Digital Tele-converter.....P. 119
- ⑭ Time lapse shooting.....P. 122
- ⑮ Face priority/Eye priority.....P. 73
- ⑯ Movie sound.....P. 125
- ⑰ Zoom operation direction/Focal length
- ⑱ Internal temperature warning.....P. 167
- ⑲ Flash.....P. 75  
(blinks: charging in progress, lights up:  
charging completed)
- ⑳ AF confirmation mark.....P. 30
- ㉑ Picture mode.....P. 81, 119
- ㉒ ISO sensitivity.....P. 74
- ㉓ White balance.....P. 83
- ㉔ AF mode.....P. 84
- ㉕ Aspect ratio.....P. 86
- ㉖ Image quality (still images).....P. 86
- ㉗ Record mode (movies).....P. 87
- ㉘ Available recording time
- ㉙ Number of storable still pictures...P. 154
- ㉚ Highlight & shadow control.....P. 100
- ㉛ Top: Flash intensity control.....P. 92  
Bottom: Exposure compensation....P. 71
- ㉜ Level gauge.....P. 28
- ㉝ Exposure compensation value.....P. 71
- ㉞ Aperture value.....P. 54–60
- ㉟ Shutter speed.....P. 54–60
- ㊱ Histogram.....P. 28
- ㊲ Preview.....P. 102
- ㊳ AE lock.....P. 102, 138
- ㊴ Shooting mode.....P. 29–68
- ㊵ Touch operation.....P. 32
- ㊶ Metering mode.....P. 95
- ㊷ Sequential shooting/Self-timer.....P. 77  
Silent shooting.....P. 45
- ㊸ Flash intensity control.....P. 92
- ㊹ Flash mode.....P. 75
- ㊺ Image stabilizer.....P. 93
- ㊻ Battery level.....P. 21
- ㊼ Live guide recall.....P. 34
- ㊽ Live view boost.....P. 133
- ㊾ Recording level meter.....P. 125
- ㊿ Silent shooting tab.....P. 68
- ㊱ Movie (exposure) mode.....P. 91

## Switching the information display

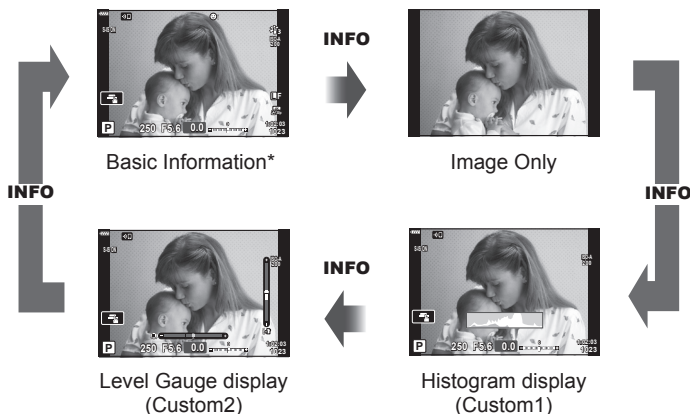
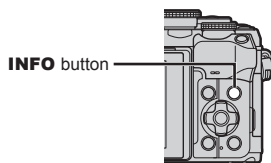
You can switch the information displayed in the monitor during shooting using the **INFO** button.



\* Not displayed in  mode (movie mode) unless recording is in progress.

- You can change Custom1 and Custom2 settings.   /Info Settings > [LV-Info] (P. 133)
- The information display screens can be switched in either direction by rotating the front dial while pressing the **INFO** button.

### Histogram display

A histogram showing the distribution of brightness in the image is displayed. The horizontal axis gives the brightness, the vertical axis the number of pixels of each brightness in the image. During shooting, overexposure is indicated in red, underexposure in blue, and the range metered using spot metering in green.



### Level gauge display

The orientation of the camera is indicated. The “tilt” direction is indicated on the vertical bar and the “horizon” direction on the horizontal bar. The camera is level and plumb when the bars turn green.

- Use the indicators on the level gauge as a guide.
- Error in the display can be corrected via calibration (P. 137).



## Choosing a shooting mode and taking photos

Use the mode dial to select the shooting mode, and then shoot the image.

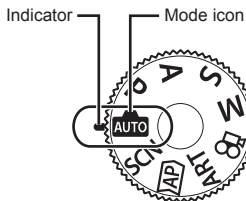

### Types of shooting modes

For how to use the various shooting modes, see the following.

Shooting mode	Description	
	The camera automatically selects the most appropriate shooting mode.	34
<b>SCN</b>	The camera automatically optimizes settings for the subject or scene.	36
	Use for quick access to advanced shooting settings.	40
<b>ART</b>	You can shoot with the effect of artistic expression added.	50
<b>P</b>	The camera meters subject brightness and automatically adjusts shutter speed and aperture for optimal results.	54
<b>A</b>	You choose the aperture and the camera automatically adjusts shutter speed for optimal results.	56
<b>S</b>	You choose the shutter speed and the camera automatically adjusts aperture for optimal results.	58
<b>M</b>	You choose both the aperture and shutter speed.	60
	Shoot movies of various types.	66

#### Functions that cannot be selected from menus

Some items may not be selectable from the menus when using the arrow pad.

- Items that cannot be set with the current shooting mode.
- Items that cannot be set because of an item that has already been set:  
Settings such as picture mode are unavailable when the mode dial is rotated to .

- 1 Rotate the mode dial to choose a mode.

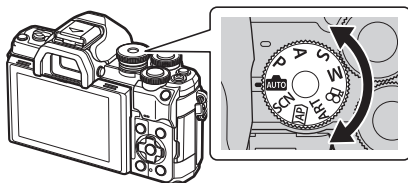

- 2 Frame the shot.

- Be careful that your fingers or the camera strap do not obstruct the lens or AF illuminator.



Landscape position

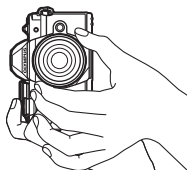

Portrait position

- 3 Adjust the focus.

- Display the subject in the center of the monitor, and lightly press the shutter button down to the first position (press the shutter button halfway).  
The AF confirmation mark (●) will be displayed, and a green frame (AF target) will be displayed in the focus location.

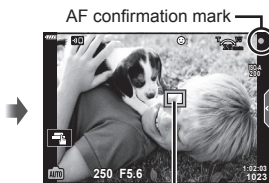
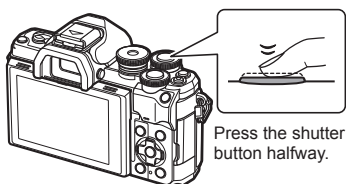

- If the AF confirmation mark blinks, the subject is not in focus (P. 164).

- 4 Release the shutter.

- Press the shutter button all the way (fully).
- The camera will release the shutter and take a picture.
- The shot image will be displayed on the monitor.

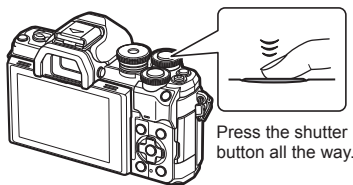

- You can focus and take pictures using touch controls.  "Shooting with touch screen operations" (P. 32)
- To exit to shooting mode from menus or playback, press the shutter button halfway.

## Taking high angle and low angle shots

You can change the orientation and angle of the monitor.

Lower angle

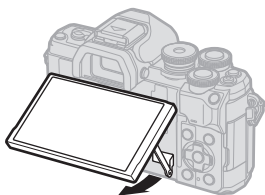

Upper angle

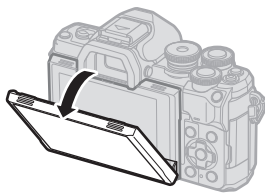

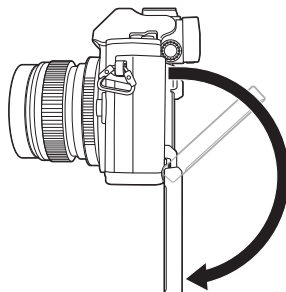
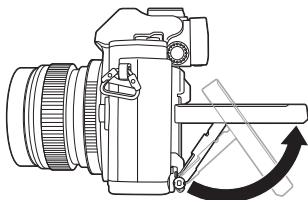

### Rotating the Monitor: Cautions

- Rotate the monitor gently within the limits shown. Do not use force; failure to observe this precaution could damage the connectors.

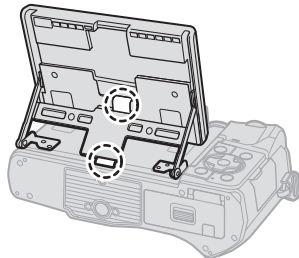
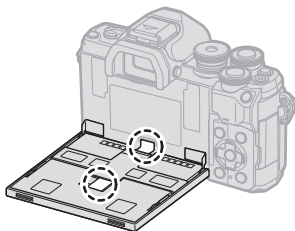

- Do not touch the areas indicated in the illustration. Failure to observe this precaution could damage the product or cause it to malfunction.





- Inverting the monitor allows you to take pictures of yourself while you preview the frame.  
     "Taking Photos in Self-Portrait Mode" (P. 69)

## Shooting with touch screen operations

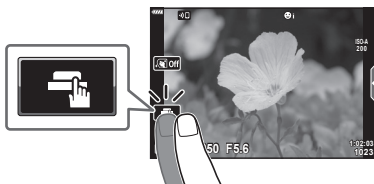
Tap  to cycle through touch screen settings.





	Tap a subject to focus and automatically release the shutter. This feature is not available in movie mode and during bulb, time, or composite photography.
	Touch screen operations are disabled.
	Tap to display an AF target and focus on the subject in the selected area. Photographs can be taken by pressing the shutter button.

### ■ Previewing the subject ()

- 1 Tap the subject in the display.
  - An AF target will be displayed.
  - Use the slider to choose the size of the frame.
  - Tap  to turn off the display of the AF target.



- 2 Tap  to zoom in at the frame position.
  - Use your finger to scroll the display when the picture is zoomed in.
  - Tap  to cancel the zoom display.
  - You cannot resize or zoom in on the target in movie mode.

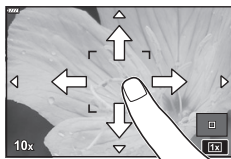

- The situations in which touch screen operations are not available include the following.
  - One-touch WB, while buttons or dials are in use, etc.
- Do not touch the display with your fingernails or other sharp objects.
- Gloves or monitor covers may interfere with touch screen operation.
- You can disable the touch screen operation.  [Touchscreen Settings] (P. 137)

## Switching Displays with the (Shortcut) Button

Press the  button to switch to each screen of the selected shooting mode between shots.

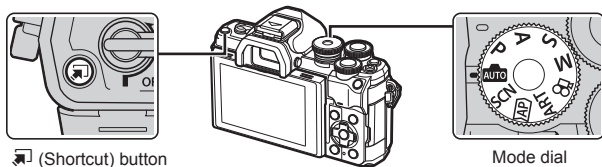

Live guide (P. 34)



**SCN**

Scene mode (P. 36)



Advanced photo mode (P. 40)



**ART**

Art filter mode (P. 50)



**P/A/S/M**

LV super control panel (P. 80)

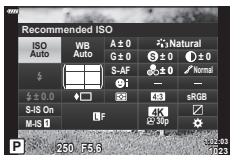

Movie mode (P. 66)



## Letting the camera choose the settings (AUTO mode)

The camera adjusts settings to suit the scene; all you have to do is press the shutter button.

Use live guides to easily adjust such parameters as color, brightness, and background blurring.

### 2

#### 1 Set the mode dial to **AUTO**.

- In auto mode, the camera automatically selects the scene mode option appropriate to your subject when you press the shutter button halfway. Once the selection has been made, the **AUTO** icon in the bottom left corner of the display will be replaced by the icon for the chosen scene.

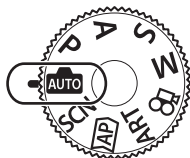

#### 2 To adjust shooting settings, display the live guide by pressing the **INFO** button.

- Use  $\Delta$ / $\nabla$  to highlight an item in the live guide and press **OK** to display a slider.



Guide item

#### 3 Use $\Delta$ / $\nabla$ to position the slider and choose a level.

- Press the **OK** button to save changes.
- To exit, press the **MENU** button.
- When [Shooting Tips] is selected, use  $\Delta$ / $\nabla$  to highlight the item and press the **OK** button to display the detail.
- The effect of the selected level is visible in the display.  
If [Blur Background] or [Express Motions] is selected, the display will return to normal, but the selected effect will be visible in the final photograph.



Slider

#### 4 To set multiple live guides, repeat Steps 2 and 3.

- A check is displayed on the guide item for live guides that are already set.
- [Blur Background] and [Express Motions] cannot be set at the same time.



#### 5 Shoot.

- To clear the live guides from the display, press the **MENU** button.
- If [RAW] is currently selected for image quality, image quality will automatically be set to RAW+JPEG.
- Certain live guide settings are not applied to the RAW copy.
- Pictures may appear gray at some live guide setting levels.

- Changes to live guide setting levels may not be visible in the monitor.
- Frame rates drop the closer the [Express Motions] slider is to [Blurred Motion].
- The flash cannot be used when a live guide is set.
- Choosing live guide settings that exceed the limits of the camera exposure meters may result in pictures that are overexposed or underexposed.



- Touch controls can also be used.

### One-Touch e-Portrait

To enable one-touch e-Portrait so that the camera smooths the complexions of portrait subjects, tap the

Off (one-touch e-Portrait) icon to turn it on ( On).

"Taking Photos in Self-Portrait Mode" (P. 69)



One-touch e-Portrait icon

## Shooting in scene mode (SCN mode)

The camera automatically optimizes settings for the subject or scene.

- 1 Rotate the mode dial to **SCN**.

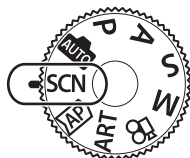

- 2 Use  $\Delta \nabla \triangleleft \triangleright$  to highlight a scene and press the  $\text{OK}$  button.

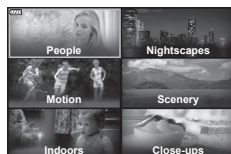

- 3 Use  $\triangleleft \triangleright$  to highlight a scene mode and press the  $\text{OK}$  button.
  - Press the  $\text{Z}$  button to choose a different scene.

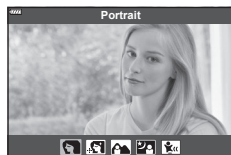

- 4 Shoot.





















- Touch controls can also be used.





### Types of scene modes



Subject type	Scene mode	Description
People	Portrait	Suitable for portrait shooting. Brings out skin texture.
	e-Portrait	Smooths out skin tones and texture. The camera records two pictures: one with the effect applied and one without.
	Portrait + Landscape	Suitable for portraits featuring a landscape in the background. Blues, greens, and skin tones are captured beautifully.
	Portrait + Nightscape	Suitable for portrait shooting against a background of night view. Raise the flash (P. 75). Use of a tripod and remote control via OI.Share is recommended (P. 143, 148).
	Children	Suitable for photographs of children and other active subjects.



Subject type	Scene mode	Description
Nightscapes	 Nightscape	Suitable for tripod shooting of night scenes. Use of a tripod and remote control via OI.Share is recommended (P. 143, 148).
	 Portrait + Nightscape	Suitable for portrait shooting against a background of night view. Raise the flash (P. 75). Use of a tripod and remote control via OI.Share is recommended (P. 143, 148).
	 Handheld Starlight	Suitable for shooting night scenes without a tripod. Reduces blur when shooting low light/illuminated scenes. The camera makes eight exposures and combines them into a single photograph.
	 Fireworks	Suitable for shooting fireworks at night. Use of a tripod and remote control via OI.Share is recommended (P. 143, 148).
	 Light Trails	The camera automatically shoots multiple images, takes newly bright areas only, and composites them into a single image. With normal long exposure, an image of light trace such as star trails with bright buildings tends to get too bright. You can capture them without over exposure while checking the progress. Press the shutter button to start shooting, then view the changing result in the monitor and press the shutter button again to end shooting once the desired result is achieved (maximum 3 hours). Use of a tripod and remote control via OI.Share is recommended (P. 143, 148). • Advanced settings can be accessed via live composite photography (dark and light field composite) in <b>M</b> mode (P. 63).
Motion	 Sport	Suitable for fast action shooting. The camera will take photos while the shutter button is pressed.
	 Children	Suitable for photographs of children and other active subjects.
	 Panning	Choose to blur the background behind moving objects. The camera chooses the optimal shutter speed for panning shots based on camera motion.

Subject type	Scene mode	Description
Scenery	 Landscape	Suitable for landscape shooting.
	 Sunset	Suitable for shooting the sunset.
	 Beach & Snow	Suitable for shooting at snow-capped mountains, seascapes in the sun, and other whitish scenes.
	 Panorama	Take panoramic photos with a wider angle of view than other shots. • For information on taking photos using this feature, see “Shooting a Panorama” (P. 46), starting from Step 3.
	 Backlight HDR	Suitable for high-contrast scenes. Each time the shutter button is pressed, the camera takes four shots and subsequently merges them into one, correctly exposed image.
Indoors	 Candlelight	Suitable for shots of candlelit scenes. Warm colors are preserved.
	 Silent [♥]	Disable camera sounds and lights in situations in which they may be unwelcome. • For information on taking photos using this feature, see “[Silent [♥]] Mode” (P. 45), starting from Step 2.
	 Portrait	Suitable for portrait shooting. Brings out skin texture.
	 e-Portrait	Smooths out skin tones and texture. The camera records two pictures: one with the effect applied and one without.
	 Children	Suitable for photographs of children and other active subjects.
	 Backlight HDR	Suitable for high-contrast scenes. Each time the shutter button is pressed, the camera takes four shots and subsequently merges them into one, correctly exposed image.

Subject type	Scene mode	Description
Close-ups	 Macro	Suitable for close-ups.
	 Nature Macro	Suitable for vivid close-ups of flowers or insects.
	 Documents	Suitable for photos of timetables or other documents. The camera heightens the contrast between the text and background.
	 Multi Focus Shot	The camera takes eight photos, varying the focus distance with each shot. <ul style="list-style-type: none"> <li>For information on taking photos using this feature, see "[Focus Bracketing]: Varying Focus Distance over a Series of Shots" (P. 49), starting from Step 2.</li> </ul>

- To maximize the benefits of the scene modes, some of the shooting function settings are disabled.
- Some time may be needed to record pictures taken using [e-Portrait]. In addition, when the image quality mode is [RAW], the image is recorded in RAW+JPEG.
- Movies cannot be recorded using [e-Portrait], [Handheld Starlight], [Panorama], or [Backlight HDR].
- [Handheld Starlight] pictures taken with [RAW] selected for image quality will be recorded in RAW+JPEG format, with the first frame recorded as a RAW image and the final composite as a JPEG image.
- [Backlight HDR] records HDR-processed images in JPEG format. When the image quality mode is set to [RAW], the image is recorded in RAW+JPEG.
- In [Panning],  is displayed during panning detection, and  is displayed when nothing is detected.
- When using a lens with an image stabilizer switch in [Panning], turn the image stabilizer switch off.

Sufficient panning effects may not be obtained in bright conditions. Use a commercially available ND filter to obtain effects more easily.

## Shooting in advanced photo mode (AP mode)

Use for quick access to advanced shooting settings.

- 1 Rotate the mode dial to **AP**.

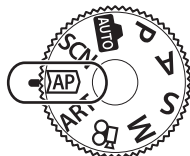

- 2 Use **<>** to highlight an AP mode.
  - Some modes offer additional options that can be accessed using **∇**.



- 3 Press the **OK** button to select the highlighted mode.
  - Press the **↔** button to choose a different mode. If additional options are displayed, press **△**.



- In some modes, the front dial can be used for exposure compensation (P. 71) and the rear dial for program shift (P. 55).
- Touch controls can also be used.

### AP Mode Options

AP mode	Description	
<b>Live Composite</b>	Record light trails from stars and other objects while keeping exposure constant overall.	41
<b>Live Time</b>	Choose for photos of fireworks and night scenery. Make long time exposures at selected shutter speeds.	42
<b>Multiple Exposure</b>	Combine two different images on top of one another.	43
<b>HDR</b>	Capture details in both highlights and shadows.	44
<b>Silent [♥]</b>	Disable camera sounds and lights in situations in which they may be unwelcome.	45
<b>Panorama</b>	Take a series of shots that are joined together to create a wide-angle photo. Choose from two angles of view: a wider angle than normal shots ( <b>STD</b> ), or an even wider angle ( <b>FULL</b> ).	46
<b>Keystone Compensation</b>	Correct the effects of perspective in photos of buildings or landscapes.	47
<b>AE Bracketing</b>	Each time the shutter button is pressed, the camera takes a series of photos, varying exposure with each shot.	48
<b>Focus Bracketing</b>	Each time the shutter button is pressed, the camera takes a series of eight photos, varying the focus distance with each shot.	49

## [Live Composite]: Live Composite Photography

Create photos that record light trails from stars and other objects without changing the brightness of the background; during shooting, the changing results can be viewed in the monitor. You can adjust white balance or picture mode and other settings not available with the **SCN** mode “Light Trails” option.

- 1 Highlight [Live Composite] in the AP mode menu (P. 40) and press the  button.
- 2 Press the shutter button halfway down to focus.
  - To reduce blur caused by camera shake, fix the camera securely to a tripod and use a remote shutter release controlled via OI.Share (P. 148).
  - If the focus indicator blinks, the camera is not in focus.
- 3 Press the shutter button all the way down to shoot.
  - The camera configures the proper settings automatically and starts shooting.
  - After pressing the shutter button, there is a time lag until shooting starts.
  - The composite image will be displayed at regular intervals.
- 4 Press the shutter button again to stop shooting.
  - View the changing result in the monitor and press the shutter button to end shooting once the desired result is achieved.
  - The recording length in one shooting is up to 3 hours.



- Advanced settings can be accessed via live composite photography (dark and light field composite) in **M** mode (P. 63).

## [Live Time]: Live Time Photography

You can make long exposures without having to keep the shutter button pressed. The changing result can be viewed in the monitor during shooting.





- 1 Highlight [Live Time] in the AP mode menu (P. 40).
- 2 Press  $\nabla$ , use  $\triangleleft \triangleright$  to choose the maximum exposure time, and press the  $\odot$  button.
  - The display refresh rate may change automatically depending on the maximum exposure time selected.
  - The shorter the maximum exposure time, the faster the display refresh rate.
- 3 Press the shutter button halfway down to focus.
  - To reduce blur caused by camera shake, fix the camera securely to a tripod and use a remote shutter release controlled via OI.Share (P. 148).
  - If the focus indicator blinks, the camera is not in focus.
- 4 Press the shutter button all the way down to start live time photography.
  - The camera adjusts settings automatically and begins shooting.
  - The changing result can be viewed in the monitor.
- 5 Press the shutter button again to stop shooting.
  - View the changing result in the monitor and press the shutter button to end shooting once the desired result is achieved.
  - Shooting ends automatically when the selected exposure time is reached.



- The long exposure (bulb/time) options in **M** mode offer more advanced settings (P. 61).

## [Multiple Exposure]: Shooting Multiple Exposures

Combine two different images on top of one another.

- 1 Highlight [Multiple Exposure] in the AP mode menu (P. 40) and press the  button.
- 2 Press the shutter button halfway down to focus.
  - If the focus indicator blinks, the camera is not in focus.
- 3 Press the shutter button all the way down for the first shot.
  -  is displayed in green if shooting starts.
  - The image is shown superimposed on the monitor.
  - Press  to delete the last shot.
- 4 Take the second shot.
  - Use the first image as a guide to compose the second shot.
  - The camera will not go to sleep while multiple exposure is in effect.
  - Performing any of the following actions automatically deletes the second shot:
    - The camera is turned off, the  button is pressed, the **MENU** button is pressed, pressing the  button, rotating the mode dial, the battery power runs out, or any cable is connected to the camera.



- For more information on creating image overlays:  “Combining Pictures (Image Overlay)” (P. 128)



- Advanced settings can be used when you select [Multiple Exposure] in the **P/A/S/M** mode.
  -  “Recording multiple exposures in a single image (Multiple Exposure)” (P. 120)

## [HDR]: Taking Composite Photos with HDR

Capture details in both highlights and shadows. The camera varies exposure over a series of four shots and combines them into a single image.

- 1 Highlight [HDR] in the AP mode menu (P. 40).
- 2 Press  $\nabla$ , use  $\triangleleft \triangleright$  to choose [HDR1] or [HDR2], and press the  $\odot$  button.

<b>HDR1</b>	Four shots are taken, each with a different exposure, and the shots are combined into one HDR image inside the camera. HDR2 provides a more impressive image than HDR1. ISO sensitivity is fixed to 200.
<b>HDR2</b>	





- 3 Press the shutter button halfway down to focus.
  - If the focus indicator blinks, the camera is not in focus.
- 4 Press the shutter button all the way down to start HDR photography.
  - The camera automatically takes four shots when the shutter button is pressed.
  - Noise may be more noticeable in photos taken in conditions associated with slow shutter speeds.
  - For best results, secure the camera by, for example, mounting it on a tripod.
  - The image displayed in the monitor or viewfinder during shooting differs from the final HDR picture.
  - The HDR-processed image will be saved as a JPEG file. When the image quality mode is set to [RAW], the image is recorded in RAW+JPEG.
  - The picture mode is fixed to [Natural] and the color space is fixed to [sRGB].





## [Silent [♥]] Mode

Disable camera sounds and lights in situations in which they may be unwelcome.

- 1 Highlight [Silent [♥]] in the AP mode menu (P. 40) and press the  button.
- 2 Press the shutter button halfway down to focus.
  - If the focus indicator blinks, the camera is not in focus.
- 3 Press the shutter button all the way down to shoot.
  - When the shutter is released, the monitor screen will go dark for a moment. No shutter sound will be emitted.
  - The desired results may not be achieved under flickering light sources such as fluorescent or LED lamps or if the subject moves abruptly during shooting.
  - When [Silent [♥]] is selected in the **SCN** or **AP** mode, the following measures are undertaken to reduce the sound and light produced by the camera.
    - Electronic shutter: Enabled
    - ): Off
    - AF Illuminator: Off
    - Flash mode: Off
  - Noise reduction is not available when [Silent [♥]] is selected in the **SCN** or **AP** mode.
  - Note that due to the electronic shutter, the subject may appear to be distorted in photographs if camera moves quickly during shooting or when shooting fast-moving subjects.





- Press  for sequential/self-timer photography (P. 77).
- Advanced settings can be used when you select Silent [♥] photography (P. 78) in the **P/A/S/M/ART** mode.  "Silent-Mode Options (Silent [♥] Settings)" (P. 123)

## Shooting a Panorama

Pan the camera following an on-screen guide to create a single wide-angle (panorama) photo.

1 Highlight [Panorama] in the AP mode menu (P. 40).

2 Press  $\nabla$ , then use  $\triangleleft \triangleright$  to highlight the desired panorama type and press the  $\odot$  button.

	Take panorama photos with a wider angle of view than other shots.
	Take panorama photos with a wider angle of view than  .



3 Highlight a pan direction using  $\triangle \nabla \triangleleft \triangleright$  and press the  $\odot$  button.

- You can also select the pan direction using the front and rear dials.



4 Press the shutter button halfway to focus.

5 Press the shutter button the rest of the way down to start shooting, and then pan the camera slowly in the direction indicated by the arrow in the display.

- The arrow in the display moves as the camera is panned.
- To cancel shooting and return to Step 3, press the **MENU** button.



6 When the arrow in the display reaches the end of the progress bar, shooting will end and the camera will create a panorama.



- Focus, exposure, and the like are fixed at the values in effect at the start of shooting.
- Before the arrow reaches the end of the progress bar, you can press the  $\odot$  button or press the shutter button again to end shooting and record a panorama from the data recorded to the current point.
- Shooting may be cancelled and an error displayed if:
  - the camera is panned too slowly or too quickly/the camera is panned diagonally/
  - the camera is panned in the opposite direction to the arrow in the display/the lens is zoomed in or out/panning does not start within a set period
- Panorama photography may be unavailable with some lenses.

## [Keystone Compensation]

Keystone distortion due to the influence of lens focal length and proximity to the subject can be corrected, or enhanced to exaggerate the effects of perspective. Keystone compensation can be previewed in the monitor during shooting. The corrected image is created from a smaller crop, slightly increasing the effective zoom ratio.

**1** Highlight [Keystone Compensation] in the AP mode menu (P. 40) and press the **OK** button.

**2** Frame the shot and adjust keystone compensation while viewing your subject in the display.

- Use the front and rear dials to choose the compensation amount.
- Use  $\Delta \nabla \triangleleft \triangleright$  to choose the area to be recorded. Depending on the compensation amount, you may be unable to choose the area recorded.
- Press and hold the **OK** button to cancel any changes.
- To adjust exposure compensation and other shooting options while keystone compensation is in effect, press the **INFO** button to view a display other than keystone compensation adjustment. To resume keystone compensation, press the **INFO** button until keystone compensation adjustment is displayed.



**3** Press the shutter button halfway down to focus.

- If the focus indicator blinks, the camera is not in focus.

**4** Press the shutter button all the way down to shoot.

- As the compensation amount increases:
  - The image will become coarser
  - The zoom ratio of the crop will increase
  - It will no longer be possible to reposition the crop in both the vertical and horizontal displays
- Photos are recorded in RAW+JPEG format when [RAW] is selected for image quality.
- The desired results may not be obtained with converter lenses.
- Depending on the amount of correction, some AF targets may be outside the display area. An icon ( $\uparrow$ ,  $\downarrow$ ,  $\leftarrow$  or  $\rightarrow$ ) is displayed when the camera focuses on an AF target outside the display area.
- If a focus distance is selected for [Image Stabilizer], the correction will be adjusted for the selected focus distance. Except when using a Micro Four Thirds or Four Thirds lens, choose a focal length using the [Image Stabilizer] option (P. 93).

## [AE Bracketing]: Varying Exposure over a Series of Shots

Take a series of photos, varying exposure with each shot.

- 1 Highlight [AE Bracketing] in the AP mode menu (P. 40).
- 2 Press  $\nabla$ , use  $\triangleleft \triangleright$  to choose the number of shots, and press the  $\text{OK}$  button.

3f	Take 3 shots, the first at optimal exposure ( $\pm 0.0$ EV), the second at $-1.0$ EV, and the third at $+1.0$ EV.
5f	Take 5 shots, the first at optimal exposure ( $\pm 0.0$ EV), the second at $-1.3$ EV, the third at $-0.7$ EV, the fourth at $+0.7$ EV, and the fifth at $+1.3$ EV.

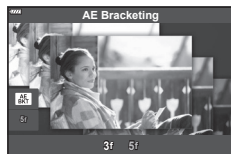



- 3 Press the shutter button halfway down to focus.
  - If the focus indicator blinks, the camera is not in focus.
- 4 Press the shutter button all the way down to shoot.
  - Take the set number of shots.
  - The  $\text{BKT}$  indicator turns green during bracketing.
  - The camera brackets the value currently selected for exposure compensation.

## [Focus Bracketing]: Varying Focus Distance over a Series of Shots

Each time the shutter button is pressed, the camera takes a series of eight photos, varying the focus distance with each shot.

- 1 Highlight [Focus Bracketing] in the AP mode menu (P. 40).
- 2 Press  $\nabla$ , use  $\triangleleft \triangleright$  to choose the amount focus distance changes with each shot, and press the  $\text{OK}$  button.

	The focus distance changes by a small amount with each shot.
	The focus distance changes by a large amount with each shot.



- 3 Press the shutter button halfway down to focus.
  - If the focus indicator blinks, the camera is not in focus.
- 4 Press the shutter button all the way down to shoot.
  - The camera takes eight photos, varying the focus distance with each shot. The camera will take pictures at, and at distances in front of and behind, the focus distance chosen when the shutter button is pressed halfway.
  - The  $\text{BKT}$  indicator turns green during bracketing.
  - Focus bracketing ends if zoom is adjusted during shooting.
  - Shooting ends when focus reaches  $\infty$  (infinity).
  - Focus bracketing uses the electronic shutter.
  - Focus bracketing is not available with lenses that have mounts conforming to the Four Thirds or some Micro Four Thirds standards.

## Using art filters (ART mode)

Using art filters, you can easily have fun with artistic effects.

- 1 Rotate the mode dial to **ART**.

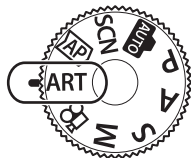

- 2 Use  $\triangleleft \triangleright$  to highlight a filter.

- The slider appears on the display when [Pop Art I] or [Soft Focus] is highlighted. Use the slider to adjust the degree of the art filter effect (P. 53).



Slider

- 3 Press  $\nabla$ , and highlight an effect using  $\triangleleft \triangleright$ .

- The effects available vary with the selected filter (Soft Focus Effect, Pin Hole Effect, Frame Effect, White Edge Effect, Star Light Effect, Color Filter, Monochrome Color, Blur Effect, or Shade Effect).

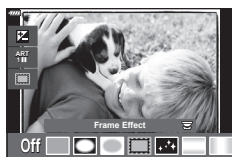

- 4 Press  $\nabla$  to adjust exposure compensation.

- The slider will appear on the display.
- Rotate the front dial to adjust exposure compensation.
- Choose positive (“+”) values to make pictures brighter, negative (“-”) values to make pictures darker. Exposure can be adjusted by  $\pm 5.0$  EV. During live view, the brightness of the monitor will be adjusted to a maximum of only  $\pm 3.0$  EV. If the exposure exceeds  $\pm 3.0$  EV, the exposure bar will begin flashing.
- To reset exposure compensation, press and hold the  $\text{OK}$  button.



Slider

Exposure bar

- 5 Press the  $\text{OK}$  button.

- 6 Shoot.

- Press the  $\text{Fn}$  button to choose a different art filter. If effects are displayed, press  $\triangle$ . If [Exposure/Brightness] is displayed, press  $\nabla$ .



- [Color Filter] (P. 97) and [Monochrome Color] (P. 98) options are available with some art filters.
- After you press the  button in Step 5, the front dial can be used for exposure compensation (P. 71) and the rear dial for program shift (P. 55).
- Touch controls can also be used.

## Types of art filters

<b>Pop Art I/II</b>	Creates an image that emphasizes the beauty of color.
<b>Soft Focus</b>	Creates an image that expresses a soft tone atmosphere.
<b>Pale&amp;Light Color I/II</b>	Creates an image that expresses warm light by scattering overall light and slightly overexposing the image.
<b>Light Tone</b>	Creates a high-quality image by softening both shadows and highlights.
<b>Grainy Film I/II</b>	Creates an image that expresses the roughness of black and white images.
<b>Pin Hole I/II/III</b>	Creates an image that looks as if it was taken using an old or toy camera by dimming the image perimeter.
<b>Diorama I/II</b>	Creates a miniature-like image by emphasizing saturation and contrast, and blurring unfocused areas.
<b>Cross Process I/II</b>	Creates an image that expresses a surreal atmosphere. Cross Process II creates an image that emphasizes magenta.
<b>Gentle Sepia</b>	Creates a high-quality image by drawing out shadows and softening the overall image.
<b>Dramatic Tone I/II</b>	Creates an image that emphasizes the difference between brightness and darkness by partially increasing contrast.
<b>Key Line I/II</b>	Creates an image that emphasizes edges and adds an illustrative style.
<b>Watercolor I/II</b>	Creates a soft, bright image by removing dark areas, blending pale colors on a white canvas, and further softening contours.
<b>Vintage I/II/III</b>	Expresses an everyday shot in a nostalgic, vintage tone using printed film discoloration and fading.
<b>Partial Color I/II/III</b>	Impressively expresses a subject by extracting colors you want to emphasize and keeping everything else monotone.
<b>Bleach Bypass I/II</b>	The "bleach bypass" effect, which you may recognize from motion pictures and the like, can be used to great effect in shots of streetscapes or metal objects.
<b>Instant Film</b>	A contemporary take on the skin tones and shadow gradations typical of film.

II and III are altered versions of the original (I).

- To maximize the benefits of the art filters, some of the shooting function settings are disabled.
- If [RAW] is currently selected for image quality (P. 86), image quality will automatically be set to RAW+JPEG. The art filter will be applied to the JPEG copy only.
- Depending on the subject, tone transitions may be ragged, the effect may be less noticeable, or the image may become more "grainy."
- Some effects may not be visible during movie recording.
- Your choice of filters, effects, and movie quality when recording movies may affect playback speed and smoothness.



## Adjusting the degree of the art filter effect (Fine-Tuning)

You can adjust the degree of the filter effect for Pop Art I and Soft Focus before taking pictures.

- 1 Select [Pop Art I] or [Soft Focus] in the art filter menu (P. 52).
  - The slider will appear on the display.
  - Rotate the front dial to fine-tune the art filter.
  - Touch controls can also be used.
  - The effect is visible in the display.
  - To reset the filter effect, press and hold the **OK** button.

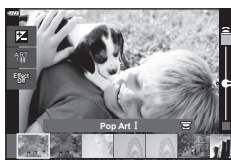

Slider

- 2 Press the **OK** button.
- 3 Shoot.
  - Press the **Reset** button if you want to fine-tune the art filter again.

## Using [Partial Color]

Record only selected hues in color.

- 1 Select [Partial Color I/II/III] in the art filter menu (P. 52).
  - A color ring appears in the display.



- 2 Rotate the front dial to select a color.
  - The effect is visible in the display.
  - Touch controls can also be used.
- 3 Press the **OK** button.
- 4 Shoot.
  - To choose a different color after shooting, press the **Reset** button.

## Letting the camera choose aperture and shutter speed (Program mode)

The camera chooses the optimal aperture and shutter speed according to subject brightness.

1 Rotate the mode dial to **P**.

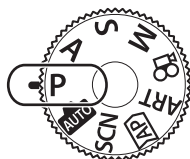

2 Focus and check the display.

- The shutter speed and aperture chosen by the camera are displayed.

3 Take pictures.

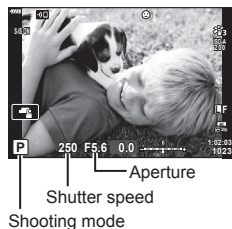

- You can use the front dial to select exposure compensation.
- You can use the rear dial to select program shift.
- The shutter speed and aperture value displays will blink if the camera is unable to achieve correct exposure. The aperture value at the moment when its indication blinks varies with the lens type and focal length of the lens. When using a fixed [ISO] setting, change the setting. "Changing ISO sensitivity (ISO)" (P. 74)

Warning display example (blinking)	Status	Action
	The subject is too dark.	Use the flash.
	The subject is too bright.	<ul style="list-style-type: none"> <li>The metered range of the camera is exceeded. A commercially available ND filter (for adjusting the amount of light) is required.</li> <li>Take pictures in silent mode.  "The Electronic Shutter (Silent [♥])" (P. 78)</li> </ul>



- You can choose the functions performed by the front and rear dials. [Dial Function] (P. 132)
- You can choose whether the display reflects the effects of exposure compensation or maintains a constant brightness for ease of viewing. At default settings, the effects of exposure settings are visible in the display. [Live View Boost] (P. 133)

## ■ Program Shift

Without changing exposure, you can choose from different combinations of aperture and shutter speed selected automatically by the camera. This is known as program shift.

- Rotate the rear dial until the camera displays the desired combination of aperture and shutter speed.
- The shooting mode indicator in the display changes from **P** to **Ps** while program shift is in effect. To end program shift, rotate the rear dial in the opposite direction until **P** is no longer displayed.



Program shift

## Choosing aperture (Aperture Priority mode)

In this mode, you choose the aperture (f/-number) and the camera automatically sets the shutter speed for optimal exposure according to subject brightness. Lower aperture values (larger apertures) reduce the depth of the area that appears to be in focus (depth of field), blurring the background. Higher aperture values (smaller apertures) increase the depth of the area that appears to be in focus in front of and behind the subject.

Lower aperture values...



...reduce depth of field and increase blur.

Higher aperture values...



...increase depth of field.

### 1 Rotate the mode dial to **A**.

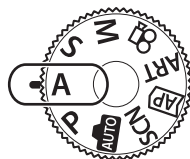

### 2 Choose an aperture.

- At default settings, aperture is selected by rotating the rear dial.
- The shutter speed selected automatically by the camera will appear in the display.
- You can use the front dial to select exposure compensation.





Aperture value

### 3 Take pictures.

- The shutter speed display will blink if the camera is unable to achieve correct exposure. When using a fixed [ISO] setting, change the setting. "Changing ISO sensitivity (ISO)" (P. 74)

Warning display example (blinking)	Status	Action
	The subject is underexposed.	Decrease the aperture value.
	The subject is overexposed.	<ul style="list-style-type: none"> <li>• Increase the aperture value.</li> <li>• If the warning display does not disappear, the metered range of the camera is exceeded. A commercially available ND filter (for adjusting the amount of light) is required.</li> <li>• Take pictures in silent mode.  "The Electronic Shutter (Silent [♥])" (P. 78)</li> </ul>



- You can choose the functions performed by the front and rear dials.  [Dial Function] (P. 132)
- You can choose whether the display reflects the effects of exposure compensation or maintains a constant brightness for ease of viewing. At default settings, the effects of exposure settings are visible in the display.  [Live View Boost] (P. 133)

## Choosing shutter speed (Shutter Priority mode)

In this mode, you choose the shutter speed and the camera automatically sets aperture for optimal exposure according to subject brightness. Faster shutter speeds appear to “freeze” fast-moving subjects. Slower shutter speeds add blur to moving objects, lending them a sense of motion for a dynamic effect.

**Slower shutter speeds...**



...produce dynamic shots with a sense of motion.

**Faster shutter speeds...**



...“freeze” the motion of fast-moving subjects.

### 1 Rotate the mode dial to **S**.

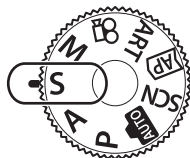

### 2 Choose a shutter speed.



- At default settings, shutter speed is selected by rotating the rear dial.
- Shutter speed can be set to values between 1/4000 and 60 s.
- Shutter speeds as fast as 1/16000 s are available in [▼] (silent) mode. “The Electronic Shutter (Silent [♥])” (P. 78)
- The aperture selected automatically by the camera will appear in the display.
- You can use the front dial to select exposure compensation.



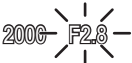

Shutter speed

### 3 Take pictures.

- The aperture value display will blink if the camera is unable to achieve correct exposure. The aperture value at the moment when its indication blinks varies with the lens type and focal length of the lens.  
When using a fixed [ISO] setting, change the setting. “Changing ISO sensitivity (ISO)” (P. 74)

Warning display example (blinking)	Status	Action
	The subject is underexposed.	Set the shutter speed slower.
	The subject is overexposed.	<ul style="list-style-type: none"> <li>• Choose a faster shutter speed. Shutter speeds as fast as 1/16000 s are available in silent mode.  "The Electronic Shutter (Silent [♥])" (P. 78)</li> <li>• If the warning display does not disappear, the metered range of the camera is exceeded. A commercially available ND filter (for adjusting the amount of light) is required.</li> </ul>



- You can choose the functions performed by the front and rear dials.  [Dial Function] (P. 132)
- You can choose whether the display reflects the effects of exposure compensation or maintains a constant brightness for ease of viewing. At default settings, the effects of exposure settings are visible in the display.  [Live View Boost] (P. 133)

## Choosing aperture and shutter speed (Manual mode)

In this mode, you choose the aperture and shutter speed. You can adjust settings according to your goals, for example by combining fast shutter speeds with small apertures (high *f*-numbers) for increased depth of field.

**1** Rotate the mode dial to **M**.

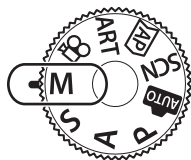



**2** Adjust aperture and shutter speed.

- At default settings, aperture is selected with the front dial and shutter speed with the rear dial.
- The exposure determined by the aperture value and shutter speed you have set and the difference from the suitable exposure measured by the camera are displayed on the monitor.
- Shutter speed can be set to values between 1/4000 and 60 seconds or to [BULB (LIVE BULB)], [TIME (LIVE TIME)], or [LIVECOMP].
- Shutter speeds as fast as 1/16000 s are available in [♥] (silent) mode.  "The Electronic Shutter (Silent [♥])" (P. 78)



**3** Take pictures.



- You can choose the functions performed by the front and rear dials.  [Dial Function] (P. 132)
- The brightness of the image displayed in the monitor will change with changes in aperture and shutter speed. You can fix the brightness of the display so that you can keep the subject in view while shooting.  [Live View Boost] (P. 133)



## Shooting with long exposure time (BULB/LIVE TIME)

Leave the shutter open for a long exposure. Use when long exposures are required, for example when photographing night scenes or fireworks.

### “Bulb” and “Live Bulb” Photography

The shutter remains open while the shutter button is pressed. Releasing the button ends the exposure.

- The amount of light entering the camera increases the longer the shutter is open.
- When live bulb photography is selected, you can choose how often the camera updates the live view display during the exposure.

### “Time” and “Live Time” Photography

The exposure begins when the shutter button is pressed all the way down. To end the exposure, press the shutter button all the way down a second time.

- The amount of light entering the camera increases the longer the shutter is open.
- When live time photography is selected, you can choose how often the camera updates the live view display during the exposure.

#### 1 Rotate the mode dial to **M**.

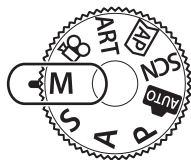

#### 2 Set the shutter speed to [BULB] or [LIVE TIME].

- At default settings, this is done by rotating the rear dial in the direction shown.

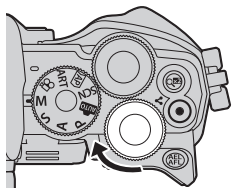

Bulb or time photography

#### 3 Press the **MENU** button.

- You will be prompted to choose the interval at which the preview is updated.

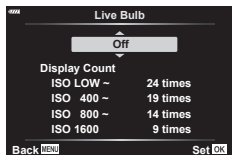

#### 4 Highlight an interval using $\Delta$ $\nabla$ on the arrow pad.

- 5 Press the **OK** button to select the highlighted option.
  - The menu will be displayed.
- 6 Press the **MENU** button to exit the menus.
  - If an option other than [Off] is selected, [LIVE BULB] or [LIVE TIME] will appear in the display.
- 7 Adjust aperture.
  - At default settings, aperture can be adjusted using the front dial.



Aperture

- 8 Take pictures.
  - In bulb mode, keep the shutter button pressed. The exposure ends when the button is released.
  - In time mode, press the shutter button all the way down once to start the exposure and again to end it.
  - The exposure ends automatically when the time selected for [Bulb/Time Timer] is reached. The default is [8 min]. The time can be changed. [Bulb/Time Timer] (P. 134)
  - [Noise Reduct.] is applied after shooting. The display shows the time remaining until the process is complete. You can choose the conditions under which noise reduction is performed (P. 134).
- During live time photography, you can refresh the preview by pressing the shutter button halfway.
- Some limitations apply to the choice of ISO sensitivity settings available.
- There are limits on the settings for the following functions.
  - Sequential shooting, self-timer shooting, time lapse shooting, image stabilizer, multiple exposure\*, etc.
  - \* When an option other than [Off] is selected for [Live Bulb] or [Live Time] (P. 134)
- [Image Stabilizer] (P. 93) turns off automatically.
- Depending on camera settings, the temperature, and the situation, you may notice noise or bright spots in the monitor. These may sometimes appear in pictures even when [Noise Reduct.] (P. 134) is enabled.

### Noise in images

While shooting at slow shutter speeds, noise may appear on screen. These phenomena occur when the temperature rises in the image pickup device or image pickup device internal drive circuit, causing current to be generated in those sections of the image pickup device that are not normally exposed to light. This can also occur when shooting with a high ISO setting in a high-temperature environment. To reduce this noise, the camera activates the noise reduction function. [Noise Reduct.] (P. 134)



- During bulb/time photography, the brightness of the subject in the display is enhanced for ease of viewing when lighting is poor. [Live View Boost] (P. 133)

## Live composite photography (dark and light field composite)

Leave the shutter open for a long exposure. You can view the light trails left by fireworks or stars and photograph them without changing the exposure of the background. The camera combines multiple shots and records them as a single photograph.

- 1 Rotate the mode dial to **M**.

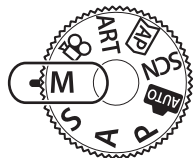

- 2 Set the shutter speed to [LIVE COMP].

- At default settings, this is done by rotating the rear dial in the direction shown.

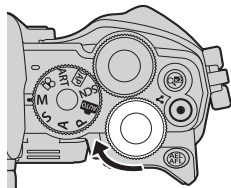

Live composite photography

- 3 Press the **MENU** button.

- The [Composite Settings] menu will be displayed.

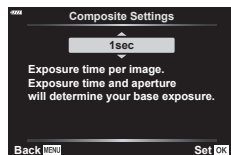

- 4 Highlight an exposure time using  $\Delta$   $\nabla$  on the arrow pad.

- Choose an exposure time of from 1/2 to 60 s.

- 5 Press the **OK** button to select the highlighted option.

- The menus will be displayed.

- 6 Press the **MENU** button repeatedly to exit the menus.

- 7 Adjust aperture.



- At default settings, aperture can be adjusted using the front dial.

- 8** Press the shutter button all the way down to ready the camera.
- The camera is ready to shoot when [Ready for composite shooting] is displayed.



- 9** Press the shutter button to start shooting.
- Live composite photography will start. The display will be updated after each exposure.
- 10** Press the shutter button again to end shooting.
- Live composite photography can continue for up to three hours. The maximum recording time available varies with battery level and shooting conditions.
  - Some limitations apply to the choice of ISO sensitivity settings available.
  - To reduce blur caused by camera shake, fix the camera securely to a tripod and use a remote shutter release controlled via OI.Share (P. 148).
  - During shooting, there are limits on the settings for the following functions.  
Sequential shooting, self-timer shooting, time lapse shooting, image stabilizer, multiple exposure, etc.
  - [Image Stabilizer] (P. 93) turns off automatically.

## Recording movies in photo shooting modes

The  button can be used for movie recording even when the mode dial is not in the  position.



- Be sure that [ REC] is assigned to the  button (P. 101).

### 1 Press the button to begin recording.

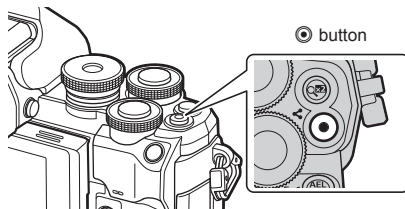
- Movie you are recording will be displayed on the monitor.
- If you put your eye to the viewfinder, movie you are recording will be displayed in the viewfinder.
- You can change the focus location by tapping the screen while recording.



### 2 Press the button again to end recording.

- The sound of touch operations and button operations may be recorded.
- CMOS image sensors of the type used in the camera generate a so-called "rolling shutter" effect that can cause distortion in pictures of moving objects. This distortion is a physical phenomenon that occurs in pictures of fast-moving subjects or if the camera is moved during shooting. It is particularly noticeable in pictures taken at long focal lengths.
- If the size of the movie file being recorded exceeds 4 GB, the file will be split automatically. (Depending on shooting conditions, movies under 4 GB in size may be split into multiple files.)
- If the camera is used for extended periods, the temperature of the image pickup device will rise and noise and colored fog may appear in images. Turn off the camera for a short time. Noise and colored fog may also appear in images recorded at high ISO sensitivity settings. If the temperature rises further, the camera will turn off automatically.
- The  button cannot be used to record movies in the following instances:
  - While shutter the button is pressed halfway; during bulb, time, composite, sequential or time lapse photography; or when e-portrait, handheld starlight, panorama, or backlight HDR is selected in **SCN** mode or keystone compensation, panorama, live time, multiple exposure, or HDR is selected in **MAP** mode
- When recording movies, use an SD card that supports an SD speed class of 10 or higher.
- A UHS-II or UHS-I card with a UHS speed class of 3 or better is required when:
  - a movie resolution of [4K] is selected in the [ ←:] menu
- When using a Four Thirds system lens, the AF will not operate while recording movies.



- Some settings, such as AF mode, can be set separately for movies and photographs.
  -  "Using the Video Menu" (P. 125)

## Recording movies in movie mode

When the mode dial is rotated to , movies can be recorded using functions such as the slow-motion mode.

- The effects available in **P**, **S**, **A**, and **M** modes can be applied to movies.  “Choosing an Exposure Mode (Movie Exposure Modes)” (P. 91)

1 Rotate the mode dial to .

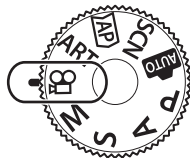





2 Use   to highlight movie mode (P. 67).



3 Press the  button to select the highlighted mode.

- Press the  button to choose a different movie mode.

4 Press the  button to begin recording.

- Be sure that  REC is assigned to the  button (P. 101).
- Press the  button again to end recording.
- The sound level during recording is shown by the recording level meter. The more the meter extends into the red, the higher the recording level.
- The recording level can be adjusted from the  video menu.  [Recording Volume] (P. 125)

Recording level meter







- A beep does not sound when the camera focuses in movie mode.



- You can prevent the camera from recording operating sounds that occur due to camera operations while shooting.  “Silencing Camera Sounds While Shooting Movies” (P. 68)
- Touch controls can also be used.

## Movie Mode Options

Movie mode	Description	
 <b>4K</b>	Shoot 4K movies.	—
 <b>Standard</b>	Shoot standard movies.	—
 <b>High-speed</b>	Record slow-motion movies. Sound will not be recorded.	68

- The picture modes available vary with the movie mode.
- When recording movies, use an SD card that supports an SD speed class of 10 or higher.
- Use UHS-II or UHS-I memory card with a UHS Speed Class of 3 when shooting in [4K] or [High-speed] mode.
- Depending on the system, some computers may be unable to play movies recorded at [4K]. See the OLYMPUS website for information on the system requirements for viewing 4K movies on a computer.

## Recording Slow Motion Movies

Record slow-motion movies. Footage shot at 120 fps plays back at 30 fps; quality is equivalent to [HD].

- 1 Highlight [High-speed] in the movie mode option (P. 67) and press the **OK** button.
- 2 Press the **⊙** button to start shooting.
  - Press the **⊙** button again to end shooting.
  - Focus and exposure are fixed at the start of recording.
  - Recording can continue for up to 20 seconds.
  - Sound will not be recorded.

## Silencing Camera Sounds While Shooting Movies

You can prevent the camera from recording operating sounds that occur due to camera operations while shooting.

Tap the silent shooting tab to display the function items.

After tapping an item, tap the displayed arrows to select the settings.

- Electronic zoom\*, recording volume, aperture, shutter speed, exposure compensation, ISO sensitivity
  - \* Only available with power zoom lenses
- The options available vary with the shooting mode.
- This option is not available in self-portrait mode (P. 69).

Silent shooting tab





## Taking Photos in Self-Portrait Mode

Inverting the monitor allows you to take pictures of yourself while you preview the frame.

**1** If the monitor is open, close it.

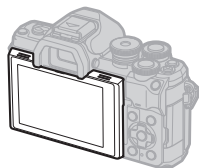

**2** Open the monitor downward.

- Read “Rotating the Monitor: Cautions” (P. 31) before moving the monitor.

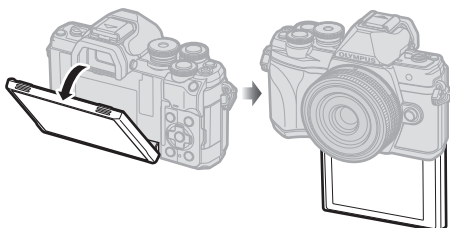

- If a power zoom lens is attached, the camera automatically switches to wide angle.
- The self portrait menu is displayed in the monitor.
- Different icons may be displayed depending on the shooting mode.



	<b>Shutter Touch</b>	When the icon is touched, the shutter is released about 1 second later.
	<b>Movie</b>	When you touch this icon, movie recording will start. To stop recording, press the  icon.
	<b>Playback</b>	Tap to switch to playback mode (P. 116).
	<b>One-Touch e-Portrait</b>	Turning this on makes skin look smooth and translucent.
	<b>One-Touch Custom Self Timer</b>	Shoot 3 frames using the self timer. You can set the number of times the shutter is released and the interval between each release using Custom Self Timer.  “Custom Self-timer” (P. 77)
	<b>Brightness adjustment (Exposure compensation)</b>	Touch [+] or [-] icon to adjust the brightness.



- 3 Frame the shot.
    - Be careful that your fingers or the camera strap do not obstruct the lens.
  - 4 Touch  and shoot.
    - You can also shoot by touching the subject displayed in the monitor, or by pressing the shutter button.
    - The shot image will be displayed on the monitor.
- Be careful not to drop the camera when using the touch screen with the camera held in one hand.

### Controlling exposure

(Exposure )

The exposure selected automatically by the camera can be altered to suit your artistic intent. Choose positive values to make pictures brighter, negative values to make them darker. Exposure compensation can be adjusted by up to  $\pm 5.0$  EV.



- Rotate the front dial to adjust exposure compensation.
- Exposure compensation is not available in , **M**, or **SCN** mode or when Live Time or panorama is selected in  mode.
- The viewfinder and live view show the effects of values not exceeding  $\pm 3.0$  EV. If the exposure exceeds  $\pm 3.0$  EV, the exposure bar will begin flashing.
- Movies can be corrected in a range up to  $\pm 3.0$  EV.









- You can choose the functions performed by the front and rear dials.  [Dial Function] (P. 132)

### Digital Zoom

(Digital Tele-converter)

This option takes a crop at the center of the frame the same dimensions as the size option currently selected for image quality and zooms it in to fill the display. The zoom ratio increases by about 2 $\times$ . This allows you to zoom in past the lens' maximum focal length, making it a good choice when you are unable to switch lenses or find it difficult to get any closer to your subject.

- Press the  button to turn on digital zoom.
-  is displayed on the monitor.
- If another role is assigned to the  button, choose [] (P. 101).
- To exit digital zoom, press the  button again.
- This function cannot be used with panorama, multiple exposure, or keystone compensation.
- When a RAW image is displayed, the area visible in the monitor is indicated by a frame.
- AF target drops.
- Digital Tele-converter can also be selected from  Shooting Menu 1 (P. 119).

## Selecting the AF target mode (AF target settings)

The frame showing the location of the focus point is referred to as the "AF target". You can change the size of the AF target. You can also select Face priority AF (P. 73).

- 1 Press the **[:::]** (<) button to display the AF target.
- 2 Select **[▪]** (Single Target) or **[:::]** (9-Target Group) using the front dial.

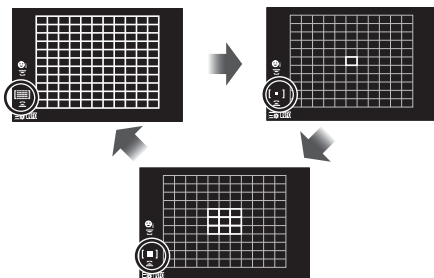

<b>[:::] All Targets</b>	The camera automatically chooses from the full set of focus targets.
<b>[▪] Single Target</b>	You can choose a single AF target.
<b>[:::] 9-Target Group</b>	The camera automatically chooses from the targets in the selected nine-target group.

- The single target mode is automatically applied in movie shooting if the group target mode is set.

## Setting the AF target

You can position the target over your subject.

- 1 Press the **[:::]** (<) button to display the AF target.
  - If **[:::]** (All Targets) is selected, select **[▪]** (Single Target) or **[:::]** (9-Target Group) using the front dial.
- 2 Use **△ ▽ ◀ ▶** to choose a focus area.
  - The size and number of the AF targets changes with the aspect ratio (P. 86) and the option selected for [Digital Tele-converter] (P. 119).



- Touch controls can also be used.

## Face priority AF/Eye priority AF

The camera automatically detects and focuses on the faces or eyes of portrait subjects. When digital ESP metering is used, exposure will be weighted according to the value metered for the face.

- 1 Press the **[:::]** (<) button to display the AF target.
- 2 Select an option using the rear dial.



	<b>Face Priority On</b>	The camera detects and focuses on faces.
	<b>Face Priority Off</b>	Face priority AF off.
	<b>Face &amp; Eye Priority On</b>	The camera detects faces and focuses on the eye closest to the camera.

- 3 Point the camera at your subject.
  - If a face is detected, it will be indicated by a white frame.
- 4 Press the shutter button halfway to focus.
  - When the camera focuses on the face in the white frame, the frame will turn green.
  - If the camera is able to detect the subject's eyes, it will display a green frame over the selected eye (eye priority AF).
- 5 Press the shutter button the rest of the way down to shoot.

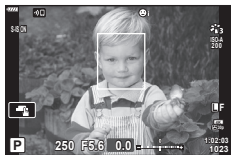

- Depending on the subject and the art filter setting, the camera may not be able to correctly detect the face.
- When set to (Digital ESP metering)] (P. 95), metering is performed with priority given to faces.



- Face priority is also available in [MF] (P. 84). Faces detected by the camera are indicated by white frames.

## Changing ISO sensitivity

(ISO)

Select a value according to subject brightness. Higher values let you photograph darker scenes but also increase image “noise” (mottling). Select [AUTO] to let the camera adjust sensitivity according to lighting conditions.

- 1 Press the ISO ( $\Delta$ ) button.
- 2 Use the front dial to select an option.



ISO

<b>AUTO</b>	Sensitivity is adjusted automatically according to shooting conditions. Use [ISO-Auto Set] (P. 134) in $\star$ Custom Menu <b>D1</b> to choose the maximum sensitivity selected by the camera and the shutter speed at which auto sensitivity control takes effect.
<b>LOW, 200–25600</b>	Choose a value for ISO sensitivity. ISO 200 offers a good balance between noise and dynamic range.

The flash can be used for flash photography in a variety of shooting conditions.

- 1 Rotate the **ON/OFF** lever to **UP** to raise the flash.

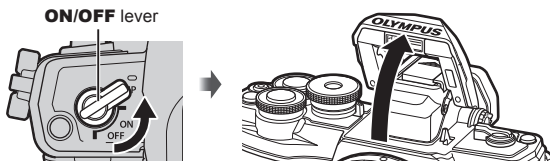

- 2 Press the **FLASH** button.

- 3 Select an item using the front dial and press the **OK** button.

- The options available and the order in which they are displayed vary depending on the shooting mode. "Flash modes that can be set by shooting mode" (P. 76)

<b>Fill In</b>	The flash fires. • Shutter speed can be set to values between that selected for [ Slow Limit] (P. 135) and [ X-Sync.] (P. 135) in  Custom Menu <b>E</b> .
<b>Redeye</b>	The flash fires so that the red-eye phenomenon is reduced.
<b>Flash Off</b>	The flash does not fire.
<b>Red-Eye Slow Slow synchronization (1st curtain/Red-eye reduction flash)</b>	The slow synchronization is combined with the red-eye reduction flash.
<b>Slow Slow synchronization (1st curtain)</b>	The flash fires with slow shutter speeds to brighten dimly-lit backgrounds.
<b>Slow2 Slow synchronization (2nd curtain)</b>	The flash fires immediately before the shutter closes to create trails of light behind moving light sources.
<b>Manual Value</b> etc.	For users who prefer manual operation. Press the <b>INFO</b> button and use  to adjust flash output.

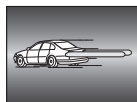

- In [ (Redeye)], after the pre-flashes, it takes about 1 second before the shutter is released. Do not move the camera until shooting is complete.
- [ (Redeye)] may not work effectively under some shooting conditions.
- When the flash fires, the shutter speed is set to 1/250 seconds or slower. When shooting a subject against a bright background with the flash, the background may be overexposed.
- The flash sync speed for the silent mode (P. 78) is 1/20 seconds or less.

### Optional Flash Units

When using optional flash units, be sure the built-in flash has been securely restored to its housing.

## Flash modes that can be set by shooting mode

Shooting mode	Monitor	Flash mode	Flash timing	Conditions for firing the flash	Shutter speed limit
P/A		Fill In	1st curtain	Always fires	30 sec. – 1/250 sec.*
		Redeye			1/30 sec. – 1/250 sec.*
		Flash Off	—	—	—
		Red-Eye Slow Slow synchronization (1st curtain/ Red-eye reduction flash)	1st curtain	Always fires	60 sec. – 1/250 sec.*
		Slow Slow synchronization (1st curtain)			
		Slow2 Slow synchronization (2nd curtain)	2nd curtain	Always fires	60 sec. – 1/250 sec.*
S/M		Fill In	1st curtain	Always fires	60 sec. – 1/250 sec.*
		Redeye			
		Flash Off	—	—	—
		Slow2 Slow synchronization (2nd curtain)	2nd curtain	Always fires	60 sec. – 1/250 sec.*

• Only and can be set in **AUTO** mode.

\* The shutter speed is 1/200 seconds when using a separately sold external flash. For the silent mode, the shutter speed is 1/20 seconds.

### Minimum range

The lens may cast shadows over objects close to the camera, causing vignetting, or the flash may be too bright even at minimum output.

Lens	Approximate distance at which vignetting occurs
14-42mm f3.5-5.6 II R	1m
ED 14-42mm f3.5-5.6 EZ	0.5m
ED 40-150mm f4.0-5.6	0.9 m
ED 14-150mm f4.0-5.6 II	0.5m











• External flash units can be used to prevent vignetting. To prevent photographs from being overexposed, select **A** or **M** mode, and choose a high aperture value or reduce ISO sensitivity.





## Performing the sequential/self-timer shooting

Adjust settings for burst or self-timer photography. Choose an option according to your subject.





- 1 Press the  (▼) button.
- 2 Use the front dial to select an option.

 <b>Single</b>	1 frame is taken at a time when the shutter button is pressed.
 <b>Sequential High</b>	With  pictures are taken at up to about 8.7 frames per second (fps) while the shutter button is pressed all the way down. With  pictures are taken at up to about 15 fps. Focus, exposure, and white balance are fixed at the values for the first shot in each series.
 <b>Sequential Low</b>	Pictures are taken at up to about 5 frames per second (fps) while the shutter button is pressed all the way down. Focus and exposure are fixed according to the options selected for [AF Mode] (P. 84) and [AEL/AFL] (P. 138).
 <b>12 sec</b>	Press the shutter button halfway to focus, the rest of the way down to start the timer. First, the self-timer lamp lights up for approximately 10 seconds, then it blinks for approximately 2 seconds and the picture is taken.
 <b>2 sec</b>	Press the shutter button halfway to focus, the rest of the way down to start the timer. The self-timer lamp blinks for approximately 2 seconds, and then the picture is taken.
 <b>Custom Self-timer</b>	Press the <b>INFO</b> button to set [  Timer], [Number of Frames], and [Interval Length]. Use <img alt="Left arrow icon" data-bbox="118 541 138 558"/> <img alt="Right arrow icon" data-bbox="118 541 138 558"/> to highlight items and   to choose a value.

Items marked with  allows you to take pictures with the small amount of blur caused by operation of the shutter reduced.

Items marked with  use the electronic shutter. Use these with shutter speeds faster than 1/4000 seconds, or in settings where the sound of the shutter would be unwelcome.

### 3 Press the button.

- Fix the camera securely on a tripod for self-timer shooting.
- If you stand in front of the camera to press the shutter button when using the self-timer, the picture may be out of focus.
- When you are using ,  or , live view is displayed. In  or , the display shows the last photograph taken during the sequential shooting.
- The speed of sequential shooting varies depending on the lens you are using and the focus of the zoom lens.
- During sequential shooting, if the battery level icon blinks due to low battery, the camera stops shooting and starts saving the pictures you have taken on the card. The camera may not save all of the pictures depending on how much battery power remains.



- To cancel the activated self-timer, press .

Take pictures using the electronic shutter. Use for shutter speeds faster than 1/4000 s or in settings where the sound of the shutter would be unwelcome. The electronic shutter can be used in single-frame mode and self-timer modes and for frame rates as high as about 15 fps in sequential shooting modes. This setting is only available in **P/A/S/M/ART** modes.

- The flash sync speed is 1/20 s.
- In [Silent [♥]] mode, [■]], [AF Illuminator], and [Flash Mode] are set to [Not Allow] by default. You can enable each operation in [Silent [♥] Settings].

**1** Press the  (▽) button.

**2** Highlight one of the options marked with ♥ using the front dial.

**3** Press the  button.

- When the shutter is released, the monitor screen will go dark for a moment. No shutter sound will be emitted.
- The desired results may not be achieved under flickering light sources such as fluorescent or LED lamps or if the subject moves abruptly during shooting.
- Note that due to the electronic shutter, the subject may appear to be distorted in photographs if camera moves quickly during shooting or when shooting fast-moving subjects.

## Calling shooting options

### ■ Live control

You can use live control to select the shooting function while checking the effect on the screen.



### ■ Available settings

Picture mode .....	P. 81	.....	P. 86
ISO sensitivity .....	P. 74	.....	P. 87
White balance .....	P. 83	Movie (exposure) mode .....	P. 91
AF mode .....	P. 84	Scene mode* <sup>2</sup> .....	P. 36
Aspect ratio* <sup>1</sup> .....	P. 86	Art filter mode* <sup>3</sup> .....	P. 50

\*1 Not available in movie mode.

\*2 Available in **SCN** mode.

\*3 Available in **ART** mode.

- 1 Press to display the live control.
  - To hide the live control, press again.

- 2 Use to highlight the desired function and to highlight a setting, and then press the button.

- You can use the front and rear dials to select a setting.
- The selected settings take effect automatically if no operations are performed for about 8 seconds.

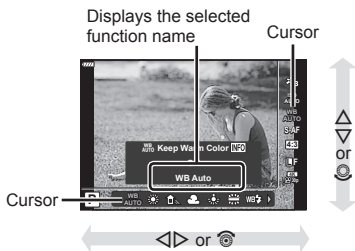

- Some items are not available in some shooting modes.



- For the default settings of each option, refer to "Defaults" (P. 169).

## ■ LV super control panel

Other shooting options can be accessed via the LV super control panel, which lists the options selected for the following shooting settings.

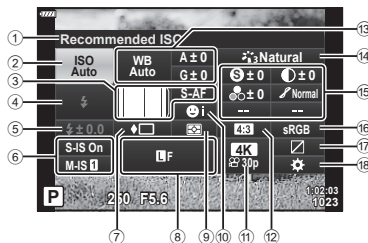

### Settings that can be modified using LV super control panel

- |  |   |
|--|---|
| ① Currently selected option                | ⑭ Picture mode.....P. 81                  |
| ② ISO sensitivity.....P. 74                | ⑮ Sharpness $\text{S}^*1$ .....P. 95      |
| ③ $\text{AF}$ mode.....P. 84               | Contrast $\text{C}^*1$ .....P. 96         |
| AF target.....P. 72                        | Saturation $\text{S}^*1$ .....P. 96       |
| ④ Flash mode.....P. 75                     | Gradation $\text{G}^*1$ .....P. 97        |
| ⑤ Flash intensity control.....P. 92        | Color filter $\text{F}^*1$ .....P. 97     |
| ⑥ Image stabilizer.....P. 93               | Monochrome color $\text{M}^*1$ .....P. 98 |
| ⑦ Sequential shooting/Self-timer.....P. 77 | Effect $\text{E}^*1$ .....P. 98           |
| ⑧ $\text{AF}$ .....P. 86                   | Color $\text{C}^*1*2$ .....P. 53          |
| ⑨ Metering mode.....P. 95                  | Color/Vivid $\text{C}^*1*3$ .....P. 81    |
| ⑩ Face priority.....P. 73                  | Effect <sup>*1</sup> .....P. 50           |
| ⑪ $\text{AF}$ .....P. 87                   | Fine-Tune <sup>*1</sup> .....P. 53        |
| ⑫ Aspect ratio.....P. 86                   | ⑯ Color space.....P. 99                   |
| ⑬ White balance.....P. 83                  | ⑰ Highlight & shadow control.....P. 100   |
| White balance compensation.....P. 94       | ⑱ Button function assignment.....P. 101   |

\*1 The display may differ when Art Filter is selected for picture mode.

\*2 Displayed when Partial Color is set.

\*3 Displayed when Color Creator is set.

### 1 Press the $\text{Fn}$ button in **P/A/S/M** modes.

- The LV super control panel will be displayed.
- In **Auto**, **ART**, **SCN**, and **AP** modes, the display of the LV super control panel is controlled via **[Control Settings]** (P. 133).
- The LV super control panel is not displayed in movie mode.

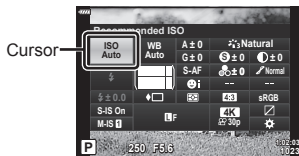

### 2 Highlight an item using $\Delta$ $\nabla$ $\leftarrow$ $\rightarrow$ and press the $\text{OK}$ button.

### 3 Use $\leftarrow$ $\rightarrow$ to highlight an option.



- Settings can also be adjusted using the dials or touch controls.
- For the default settings of each option, refer to “Defaults” (P. 169).

Choose how pictures are processed during shooting to enhance color, tone, and other properties. Choose from preset picture modes according to your subject or artistic intent. Contrast, sharpness, and other settings can be adjusted separately for each mode. You can also add artistic effects using art filters. Art filters give you the option of added frame effects and the like. Adjustments to individual parameters are stored separately for each picture mode and art filter.

- This item applies during both still photography and movie recording.

- 1 Press the **OK** button and use **Δ**/**▽** to highlight Picture Mode.
- 2 Highlight an option using **◀**/**▶** and press the **OK** button.



Picture Mode

### Picture mode options

<b>i-Enhance</b>	The camera adjusts colors and contrast for optimal results according to the type of subject (P. 98).
<b>Vivid</b>	Choose for vivid colors.
<b>Natural</b>	Choose for natural colors.
<b>Muted</b>	Choose for pictures that will later be retouched.
<b>Portrait</b>	Enhance skin tones.
<b>Monochrome</b>	Record pictures in monochrome. You can apply color filter effects and choose a tint (P. 98).
<b>Custom</b>	Adjust picture mode parameters to create a custom version of a selected picture mode.
<b>e-Portrait</b>	Smooth complexions.
<b>Color Creator</b>	Adjust hue and color to suit your creative intent
<b>ART 1 Pop Art*<sup>1</sup></b>	Uses Art Filter settings. Art effects can also be used.
<b>ART 2 Soft Focus*<sup>1</sup></b>	
<b>ART 3 Pale&amp;Light Color</b>	
<b>ART 4 Light Tone</b>	
<b>ART 5 Grainy Film</b>	
<b>ART 6 Pin Hole</b>	
<b>ART 7 Diorama</b>	
<b>ART 8 Cross Process</b>	
<b>ART 9 Gentle Sepia</b>	
<b>ART 10 Dramatic Tone</b>	
<b>ART 11 Key Line</b>	
<b>ART 12 Watercolor</b>	
<b>ART 13 Vintage</b>	
<b>ART 14 Partial Color*<sup>2</sup></b>	
<b>ART 15 Bleach Bypass</b>	
<b>ART 16 Instant Film</b>	

- \*1 After choosing Pop Art I or Soft Focus using the  $\triangleleft \triangleright$  buttons, press the **INFO** button to display the slider for Fine Tuning (P. 53).
- \*2 After choosing Partial Color using  $\triangleleft \triangleright$ , press the **INFO** button to display the color ring (P. 53).

## Adjusting overall color (Color Creator)

The overall color of the image can be adjusted using any combination of 30 hues and 8 saturation levels.

- 1** Press the  $\odot$  button and use  $\triangle \nabla$  to highlight Picture Mode.



Picture Mode

- 2** Highlight [Color Creator] using  $\triangleleft \triangleright$  and press the **INFO** button.
- 3** Adjust saturation and hue.
- Rotate the front dial to adjust hue.
  - Rotate the rear dial to adjust saturation.
  - To restore default values, press and hold the  $\odot$  button.
- 4** Press the  $\odot$  button to save changes.
- You can also save changes by pressing the shutter button halfway.
- Photos are recorded in RAW+JPEG format when [RAW] is selected for image quality (P. 86).
  - Pictures taken using [Multiple Exposure] (P. 120) are recorded at the [Natural] setting.



White balance (WB) ensures that white objects in images recorded by the camera appear white. [AUTO] is suitable in most circumstances, but other values can be selected according to the light source when [AUTO] fails to produce the desired results or you wish to introduce a deliberate color cast into your images.

- 1 Press the **OK** button and use  $\Delta$   $\nabla$  to highlight White Balance.
- 2 Highlight an option using  $\triangleleft$   $\triangleright$  and press the **OK** button.



White Balance

WB mode		Color temperature	Light conditions
Auto white balance	AUTO	—	For most light conditions (when there is a white portion framed on the monitor). Use this mode for general use. <ul style="list-style-type: none"> <li>• When this option is highlighted, you can press the <b>INFO</b> button and use <math>\Delta</math> <math>\nabla</math> <math>\triangleleft</math> <math>\triangleright</math> or the front or rear dial to select [On] or [Off] for [WB Auto Keep Warm Color] (P. 135).</li> </ul>
Preset white balance		5300 K	For shooting outdoors on a clear day, or to capture the reds in a sunset or the colors in a fireworks display
		7500 K	For shooting outdoors in the shadows on a clear day
		6000 K	For shooting outdoors on a cloudy day
		3000 K	For shooting under a tungsten light
		4000 K	For shooting under a fluorescent light
		5500 K	For flash shooting
One-touch white balance		Color temperature set by one-touch WB	Press the <b>INFO</b> button to measure white balance using a white or gray target when using a flash or other light source of an unknown type or when shooting under mixed lighting.  “One-touch white balance” (P. 84)
Custom white balance	CWB	2000 K–14000 K	After pressing the <b>INFO</b> button, use $\Delta$ $\nabla$ $\triangleleft$ $\triangleright$ to select a color temperature and then press the <b>OK</b> button.

### One-touch white balance

Measure white balance by framing a piece of paper or other white object under the lighting that will be used in the final photograph. This is useful when shooting a subject under natural light, as well as under various light sources with different color temperatures.

- 1 Select [W1], [W2], [W3], or [W4] (one-touch white balance 1, 2, 3, or 4) and press the **INFO** button.
- 2 Photograph a piece of colorless (white or gray) paper.
  - Frame the paper so that it fills the display and no shadows fall it.
  - The one-touch white balance screen appears.
- 3 Select [Yes] and press the **OK** button.
  - The new value is saved as a preset white balance option.
  - The new value is stored until one-touch white balance is measured again. Turning the power off does not erase the data.

### Choosing a focus mode (AF Mode)

You can select a focusing method (focus mode). You can choose separate focusing methods for still photography mode and movie mode.

- 1 Press the **OK** button and use  $\Delta \nabla$  to highlight AF Mode.



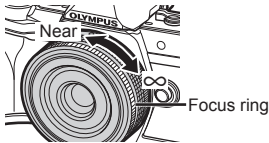

AF Mode

- 2 Highlight an option using  $\leftarrow \rightarrow$  and press the **OK** button.

<b>S-AF</b> (Single AF)	The camera focuses once when the shutter button is pressed halfway. When the focus is locked, a beep sounds, and the AF confirmation mark and the AF target mark light up. This mode is suitable for taking pictures of still subjects or subjects with limited movement.
<b>C-AF</b> (Continuous AF)	The camera repeats focusing while the shutter button remains pressed halfway. When the subject is in focus, the AF confirmation mark lights up on the monitor and the beep sounds when the focus is locked at the first time. Even if the subject moves or you change the composition of the picture, the camera continues trying to focus.
<b>MF</b> (Manual focus)	This function allows you to manually focus on any position by operating the focus ring on the lens. 



<b>S-AF+MF</b> (Simultaneous use of S-AF mode and MF mode)	After pressing the shutter button halfway to focus in [S-AF] mode, you can turn the focus ring to fine-adjust focus manually.
<b>C-AF+TR</b> (AF tracking)	Press the shutter button halfway to focus; the camera then tracks and maintains focus on the current subject while the shutter button is held in this position. <ul style="list-style-type: none"> <li>The AF target is displayed in red if the camera can no longer track the subject. Release the shutter button and then frame the subject again and press the shutter button halfway.</li> </ul>

- The camera may be unable to focus if the subject is poorly lit, obscured by mist or smoke, or lacks contrast.
- AF mode is unavailable when a Four Thirds system lens is used.
- AF mode is unavailable when the lens MF focus clutch is set to MF.
- If [MF], [C-AF], or [C-AF+TR] is selected in **P**, **A**, **S**, **M**,  or **ART** mode, the shutter can be released even when the camera is not focus.
- If [C-AF] or [C-AF+TR] is selected, keep the shutter button pressed halfway to let the camera focus on the subject for a little while, and then press the shutter button all the way down to shoot.
- If you operate the zoom during sequential shooting when [C-AF] or [C-AF+TR] is selected, the focus may move off the subject.
- If shooting a fast-moving person in sequential shooting mode when [C-AF] is selected, it is recommended that you select  Face Priority Off (P. 73).
- If shooting a fast-moving subject in sequential shooting mode when [C-AF+TR] is selected, the focus may move off the subject.



- The focus method can be chosen in the  custom menu.  "AEL/AFL" (P. 138)

## Setting the image aspect

Choose the ratio of width to height for pictures according to your intent or your goals for printing or the like. In addition to the standard aspect (width-to-height) ratio of [4:3], the camera offers settings of [16:9], [3:2], [1:1], and [3:4].

- 1 Press the **OK** button and use **Δ** **▽** to highlight Image Aspect.
- 2 Use **◀▶** to choose a value and press the **OK** button.



Image Aspect

- Image aspect can only be set for still images.
- JPEG images are recorded at the selected aspect ratio. RAW images are the same size as the image sensor and are recorded at an aspect ratio of 4:3 with a tag indicating the aspect ratio selected. A crop indicating the selected aspect ratio is displayed when images are played back.

## Selecting image quality (Still image quality, **📷** **⏪**)

You can set an image quality mode for still images. Select a quality suitable for the application (such as for processing on PC, use on website etc.).

- 1 Press the **OK** button and use **Δ** **▽** to highlight (Still image quality, **📷** **⏪**).



Still Image Quality

- 2 Highlight an option using **◀▶** and press the **OK** button.
  - Choose from JPEG (**L**SF, **L**F, **L**N, and **M**N) and RAW modes. Choose a JPEG+RAW option to record both a JPEG and a RAW image with each shot. JPEG modes combine image size (**L**, **M**, and **S**) and compression ratio (SF, F, and N).
  - When you want to select a combination other than **L**SF, **L**F, **L**N, and **M**N, change the [**⏪**- Set] (P. 135) settings in Custom Menu.

### RAW image data

RAW images consist of unprocessed image data to which settings such as exposure compensation and white balance have yet to be applied. They serve as raw data for images that will be processed after shooting. RAW image files:









- Have the extension ".orf"
- Cannot be viewed on other cameras
- Can be viewed on computers using Olympus Workspace photo editing software
- Can be saved in JPEG format using the [RAW Data Edit] (P. 126) retouch option in the camera menus

**🔗** "Retouching Pictures (Edit)" (P. 126)

## Selecting image quality

(Movie quality,  )

Choose the image quality options available for movie recording. When choosing an option, consider how the movie will be used: for example, are you planning to process it on a computer, or is it intended for upload to a website?

- 1 Press the  button and use   to highlight (Movie quality,  .
- 2 Use   to choose a value and press the  button.



Movie Quality

2













Shooting

### ■ Available Movie Quality Options

















The options available for movie quality vary with the movie mode (P. 67) and the options selected for [Video Frame Rate] and [Video Bit Rate] in the video menu (P. 125).

- When shooting movies that will be viewed on a television, choose a frame rate that matches the video standard used in the device, as otherwise the movie may not play back smoothly. Video standards vary by country or region: some use NTSC, others PAL.
  - When shooting for display on NTSC devices, choose 60p (30p)
  - When shooting for display on PAL devices, choose 50p (25p)

The following options are available when the mode dial is rotated to a position other than :





Movie quality	Movie quality components
 3840×2160 30p	Choose the desired combination of frame size, bit rate, and frame rate.  
 3840×2160 25p	
 3840×2160 24p	
 1920×1080 Super Fine 60p	
 1920×1080 Super Fine 30p	
 1280×720 Super Fine 30p	
 1920×1080 Fine 60p	
 1920×1080 Fine 30p	
 1280×720 Fine 30p	
 1920×1080 Normal 60p	
 1920×1080 Normal 30p	

- ① Frame size  
 4K : 3840×2160  
 FHD : 1920×1080  
 HD : 1280×720
- ② Bit rate (compression ratio)\*1  
 SF (Super Fine), F (Fine), N (Normal)
- ③ Frame rate  
 30p (60p), 25p (50p), 24p

Movie quality	Movie quality components
 1280×720 Normal 30p	<p>Choose the desired combination of frame size, bit rate, and frame rate.</p>  <p>① Frame size            4K : 3840×2160            FHD : 1920×1080            HD : 1280×720</p> <p>② Bit rate (compression ratio)*1            SF (Super Fine), F (Fine), N (Normal)</p> <p>③ Frame rate            30p (60p), 25p (50p), 24p</p>
 1920×1080 Super Fine 50p	
 1920×1080 Super Fine 25p	
 1280×720 Super Fine 25p	
 1920×1080 Fine 50p	
 1920×1080 Fine 25p	
 1280×720 Fine 25p	
 1920×1080 Normal 50p	
 1920×1080 Normal 25p	
 1280×720 Normal 25p	
 1920×1080 Super Fine 24p	
 1280×720 Super Fine 24p	
 1920×1080 Fine 24p	
 1280×720 Fine 24p	
 1920×1080 Normal 24p	
 1280×720 Normal 24p	

\*1 The bit rate can not be changed when the frame size is [4K].

The following options are available when [4K] is selected for movie mode \*2:



Movie quality	Movie quality components
 3840×2160 30p	Choose the desired combination of frame size and frame rate.  
 3840×2160 25p	
 3840×2160 24p	

① Frame size  
4K : 3840×2160

② Frame rate  
30p, 25p, 24p

\*2 The bit rate can not be changed.

The following option is available when [High-speed] is selected for movie mode \*3:

























Movie quality	Movie quality components
 1280×720 HighSpeed 120fps	

① Frame size  
HD : 1280×720

② Frame rate  
120fps

\*3 The frame rate and bit rate can not be changed.







The following options are available when [Standard] is selected for movie mode:

Movie quality	Movie quality components
 1920×1080 Super Fine 60p	<p>Choose the desired combination of frame size, bit rate, and frame rate.</p>  <p>① Frame size FHD : 1920×1080 HD : 1280×720</p> <p>② Bit rate (compression ratio) SF (Super Fine), F (Fine), N (Normal)</p> <p>③ Frame rate 30p (60p), 25p (50p), 24p</p>
 1920×1080 Super Fine 30p	
 1280×720 Super Fine 30p	
 1920×1080 Fine 60p	
 1920×1080 Fine 30p	
 1280×720 Fine 30p	
 1920×1080 Normal 60p	
 1920×1080 Normal 30p	
 1280×720 Normal 30p	
 1920×1080 Super Fine 50p	
 1920×1080 Super Fine 25p	
 1280×720 Super Fine 25p	
 1920×1080 Fine 50p	
 1920×1080 Fine 25p	
 1280×720 Fine 25p	
 1920×1080 Normal 50p	
 1920×1080 Normal 25p	
 1280×720 Normal 25p	
 1920×1080 Super Fine 24p	
 1280×720 Super Fine 24p	
 1920×1080 Fine 24p	
 1280×720 Fine 24p	
 1920×1080 Normal 24p	
 1280×720 Normal 24p	

- Movies are stored in MPEG-4 AVC/H.264 format. The maximum size of individual file is limited to 4 GB. The maximum recording time of individual movie is limited to 29 minutes.
- Depending on the type of card used, recording may end before the maximum length is reached.

## Choosing an Exposure Mode (Movie Mode (Movie Exposure Modes))

You can create movies that take advantage of the effects available in **P**, **A**, **S**, and **M** modes. This option takes effect when the mode dial is rotated to .

- 1 Rotate the mode dial to .
- 2 Press the  button and use   to highlight movie (exposure) mode.
- 3 Use   to choose a value and press the  button.



Movie (exposure) mode

<b>P</b>	Exposure is automatically adjusted in response to subject brightness. Use the front dial to adjust exposure compensation.
<b>A</b>	Depiction of background is changed by setting the aperture. Use the front dial to adjust exposure compensation and rear dial to adjust aperture.
<b>S</b>	Shutter speed affects how the subject appears. Use the front dial to adjust exposure compensation and rear dial to adjust shutter speed. Shutter speed can be set to values between 1/24 s and 1/4000 s.
<b>M</b>	Aperture and shutter speed can be manually set. Use the front dial to select aperture value and the rear dial to select shutter speed. Shutter speed can be set to values between 1/24 s and 1/4000 s. ISO sensitivity can only be set manually to values between 200 and 6400.





- Blurred frames caused by such factors as the subject moving while the shutter is open can be reduced by selecting the fastest available shutter speed.
- The low end of the shutter speed changes according to the frame rate of the movie record mode.



- You can choose the functions performed by the front and rear dials.  [Dial Function] (P. 132)

## Adjusting flash output (Flash intensity control)

Flash output can be adjusted if you find that your subject to appears overexposed, or is underexposed even though the exposure in the rest of the frame is just right.

- 1 Press the  button in **P/A/S/M** modes.
  - In **Auto**, **ART**, **SCN**, and **AP** modes, the display of the LV super control panel is controlled via  Control Settings] (P. 133).
- 2 Use  $\Delta$   $\nabla$   $\triangleleft$   $\triangleright$  to select , then press the  button.
- 3 Use  $\triangleleft$   $\triangleright$  to choose a value and press the  button.

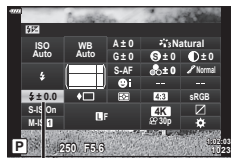

Flash intensity control









- This setting has no effect when the flash control mode for the external flash unit is set to MANUAL.
- Changes to flash intensity made with the external flash unit are added to those made with the camera.



## Reducing camera shake (Image Stabilizer)

You can reduce the amount of camera shake that can occur when shooting in low light situations or shooting with high magnification.

The image stabilizer starts when you press the shutter button halfway.

- Press the  button in **P/A/S/M** modes.
  - In **Auto**, **ART**, **SCN**, and **AP** modes, the display of the LV super control panel is controlled via [Control Settings] (P. 133).
- Use     to select [Image Stabilizer], then press the  button.
- Highlight an option using   and press the  button.

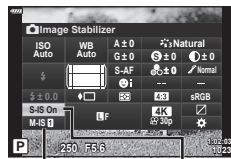

 Image Stabilizer





 Image Stabilizer

Still picture (S-IS)	S-IS Off	Image stabilizer is off.
	S-IS On	The camera detects the panning direction and applies the appropriate image stabilization.
Movie (M-IS)	M-IS Off	Image stabilizer is off.
	M-IS <b>1</b>	The camera uses both sensor shift (VCM) and electronic correction.
	M-IS <b>2</b>	The camera uses sensor shift (VCM) correction only. Electronic correction is not used.

- The edges of the frame are cropped out when [M-IS **1**] is selected, reducing the area recorded.
- The image stabilizer cannot correct excessive camera shake or camera shake that occurs when the shutter speed is set to the slowest speed. In these cases, it is recommended that you use a tripod.
- When using a tripod, set [Image Stabilizer] to [S-IS Off]/[M-IS Off].
- When using a lens with an image stabilization function switch, priority is given to the lens side setting.
- You may notice an operating sound or vibration when the image stabilizer is activated.

### Using lenses other than Micro Four Thirds/Four Thirds System lenses

You can use focal length information to reduce camera shake when shooting with lenses that are not Micro Four Thirds or Four Thirds system lenses.





- Press the **INFO** button while [Image Stabilizer] is selected, use     to highlight a focal length, and press the  button.
- Choose a focal length between 0.1 mm and 1000.0 mm.
- Choose the value that matches the one printed on the lens.
- Selecting [Reset] (basic) in Shooting Menu 1 does not reset the focal length.

## Making fine adjustments to white balance (WB Compensation)

You can set and finely adjust the compensation values for both auto white balance and preset white balance.

Before proceeding, choose a white balance option to which to make fine adjustments.

☞ “Adjusting color (WB (white balance))” (P. 83)

- 1 Press the  button in **P/A/S/M** modes.
  - In **Auto**, **ART**, **SCN**, and **AP** modes, the display of the LV super control panel is controlled via  Control Settings] (P. 133).
- 2 Highlight white balance compensation using  $\Delta$   $\nabla$   $\triangleleft$   $\triangleright$  and press the  button.
- 3 Use  $\triangleleft$   $\triangleright$  to choose an axis.
- 4 Choose a value using  $\Delta$   $\nabla$  and press the  button.

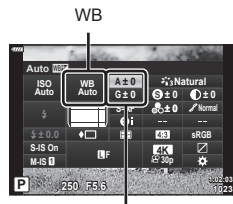

White balance compensation

### For compensation on the A axis (Red-Blue)

Move the bar in the + direction to emphasize red tones and in the – direction to emphasize blue tones.





### For compensation on the G axis (Green-Magenta)

Move the bar in the + direction to emphasize green tones and in the – direction to emphasize magenta tones.

- Selecting [Reset] (basic) in Shooting Menu 1 does not reset the values selected.









## Choosing how the camera measures brightness (Metering)

You can choose how the camera meters subject brightness.

- 1 Press the  button in **P/A/S/M** modes.
  - In **Auto**, **ART**, **SCN**, and **AP** modes, the display of the LV super control panel is controlled via [  Control Settings] (P. 133).
- 2 Use  $\Delta \nabla \triangleleft \triangleright$  to select [Metering], then press the  button.
- 3 Highlight an option using  $\triangleleft \triangleright$  and press the  button.







Metering

 <b>Digital ESP metering</b>	Meters exposure in 324 areas of the frame and optimizes exposure for the current scene or portrait subject (if an option other than [OFF] is selected for [  Face Priority]). This mode is recommended for general use.	
 <b>Center weighted averaging metering</b>	Provides the average metering between the subject and the background lighting, placing more weight on the subject at the center.	
 <b>Spot metering</b>	Meters a small area (about 2% of the frame) with the camera pointed at the object you wish to meter. Exposure will be adjusted according to the brightness at the metered point.	
 <b>Spot metering (highlight)</b>	Increases spot metering exposure. Ensures bright subjects appear bright.	
 <b>Spot metering (shadow)</b>	Lowers spot metering exposure. Ensures dark subjects appear dark.	

## Making fine adjustments to sharpness (Sharpness)

Adjust image sharpness. Outlines can be emphasized for a sharp, clear picture. Settings are stored separately for each picture mode.

- Adjustments may not be available depending on the shooting mode.

- 1 Press the  button in **P/A/S/M** modes.
  - In **Auto**, **ART**, **SCN**, and **AP** modes, the display of the LV super control panel is controlled via [  Control Settings] (P. 133).
- 2 Use  $\Delta \nabla \triangleleft \triangleright$  to select [Sharpness], then press the  button.
- 3 Adjust sharpness using  $\triangleleft \triangleright$  and press the  button.

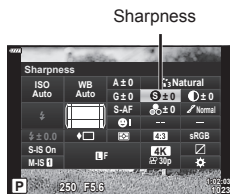



Sharpness

## Making fine adjustments to contrast (Contrast)

Adjust image contrast. Increasing contrast heightens the difference between bright and dark areas for a harder, more well-defined picture. Settings are stored separately for each picture mode.

- Adjustments may not be available depending on the shooting mode.

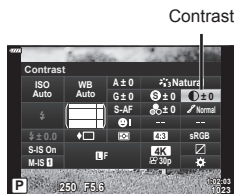

- Press the  button in **P/A/S/M** modes.
  - In **Auto**, **ART**, **SCN**, and **AP** modes, the display of the LV super control panel is controlled via **[Control Settings]** (P. 133).
- Use  $\Delta$   $\nabla$   $\triangleleft$   $\triangleright$  to select [Contrast], then press the  button.
- Adjust contrast using  $\triangleleft$   $\triangleright$  and press the  button.



## Making fine adjustments to saturation (Saturation)

Adjust color saturation. Increasing saturation makes pictures more vivid. Settings are stored separately for each picture mode.

- Adjustments may not be available depending on the shooting mode.

- Press the  button in **P/A/S/M** modes.
  - In **Auto**, **ART**, **SCN**, and **AP** modes, the display of the LV super control panel is controlled via **[Control Settings]** (P. 133).
- Use  $\Delta$   $\nabla$   $\triangleleft$   $\triangleright$  to select [Saturation], then press the  button.
- Adjust saturation using  $\triangleleft$   $\triangleright$  and press the  button.

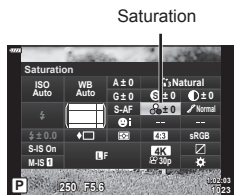

## Making fine adjustments to tone (Gradation)

Adjust color brightness and shading. Bring pictures closer to what you envisage by, for example, brightening the entire picture. Settings are stored separately for each picture mode.

- Adjustments may not be available depending on the shooting mode.

- Press the button in **P/A/S/M** modes.
  - In **Auto**, **ART**, **SCN**, and **AP** modes, the display of the LV super control panel is controlled via [ Control Settings] (P. 133).
- Use  $\Delta$   $\nabla$   $\triangleleft$   $\triangleright$  to select [Gradation], then press the button.
- Adjust tone using  $\triangleleft$   $\triangleright$  and press the button.

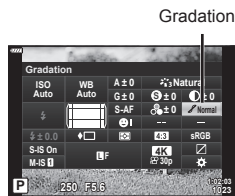

<b>Auto</b> (Shadow Adj)	Divides the image into detailed regions and adjusts the brightness separately for each region. This is effective for images with areas of large contrast in which the whites appear too bright or the blacks appear too dark.
<b>Normal</b> (Gradation Normal)	Optimal shading. Recommended in most circumstances.
<b>High</b> (Gradation High Key)	Uses a tone suitable for a bright subject.
<b>Low</b> (Gradation Low Key)	Uses a tone suitable for a dark subject.

## Applying filter effects to monochrome pictures (Color Filter)

Color filter effects can be added when [Monochrome] is selected for picture mode (P. 81). Depending on the color of the subject, color filter effects can make subjects brighter or enhance contrast. Orange adds more contrast than yellow, red more contrast than orange. Green is a good choice for portraits and the like.



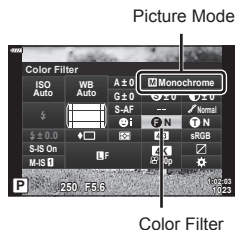







- Press the button in **P/A/S/M** modes.
  - In **Auto**, **ART**, **SCN**, and **AP** modes, the display of the LV super control panel is controlled via [ Control Settings] (P. 133).
- Use  $\Delta$   $\nabla$   $\triangleleft$   $\triangleright$  to select [Color Filter], then press the button.
- Highlight an option using  $\triangleleft$   $\triangleright$  and press the button.



<b>N:None</b>	Creates a normal black and white image.
<b>Ye:Yellow</b>	Reproduces clearly defined white cloud with natural blue sky.
<b>Or:Orange</b>	Slightly emphasizes colors in blue skies and sunsets.
<b>R:Red</b>	Strongly emphasizes colors in blue skies and brightness of crimson foliage.
<b>G:Green</b>	Strongly emphasizes colors in red lips and green leaves.

## Adjusting the tone of a monochrome image (Monochrome Color)

Add a tint to black-and-white pictures in the [Monochrome] picture mode (P. 81).



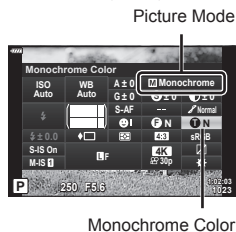







- 1 Press the  button in **P/A/S/M** modes.
  - In **Auto**, **ART**, **SCN**, and **AP** modes, the display of the LV super control panel is controlled via  Control Settings] (P. 133).
- 2 Use     to select [Monochrome Color], then press the  button.
- 3 Use   to choose a value and press the  button.







<b>N:Normal</b>	Creates a normal black and white image.
<b>S:Sepia</b>	Shoot in sepia-tinted monochrome.
<b>B:Blue</b>	Shoot in blue-tinted monochrome.
<b>P:Purple</b>	Shoot in purple-tinted monochrome.
<b>G:Green</b>	Shoot in green-tinted monochrome.

## Adjusting i-Enhance effects (Effect)

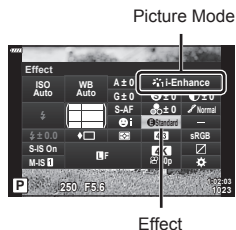
Choose the strength of the i-Enhance effect when [i-Enhance] is selected for picture mode (P. 81).



- 1 Press the  button in **P/A/S/M** modes.
  - In **Auto**, **ART**, **SCN**, and **AP** modes, the display of the LV super control panel is controlled via  Control Settings] (P. 133).
- 2 Use     to select [Effect], then press the  button.
- 3 Adjust the effect using   and press the  button.



 <b>Low (Effect: Low)</b>	Adds a low i-Enhance effect to images.
 <b>Standard (Effect: Standard)</b>	Adds an i-Enhance effect between “low” and “high” to images.
 <b>High (Effect: High)</b>	Adds a high i-Enhance effect to images.

## Setting the color reproduction format (Color Space)

You can select a format to ensure that colors are correctly reproduced when shot images are regenerated on a monitor or using a printer. This option is equivalent to the [Color Space] (P. 135) in Custom Menu.

- 1 Press the  button in **P/A/S/M** modes.
  - In **AUTO**, **ART**, **SCN**, and **AP** modes, the display of the LV super control panel is controlled via [Control Settings] (P. 133).
- 2 Use  $\Delta$   $\nabla$   $\langle$   $\rangle$  to select [Color Space], then press the  button.
- 3 Select a color format using  $\langle$   $\rangle$  and press the  button.

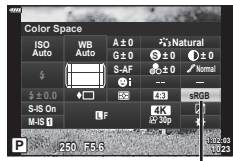

Color Space



<b>sRGB</b>	The established color space standard for Windows systems. It is widely supported across displays, printers, digital cameras, and computer applications. This setting is recommended in most circumstances.
<b>AdobeRGB</b>	A color space standard defined by Adobe Systems Inc. It can reproduce a wider gamut of colors than sRGB. Accurate color reproduction is available only with software and devices (displays, printers, and the like) that support this standard. An underscore (“_”) appears at the beginning of the file name (e.g., “_xxx0000.jpg”).

- [AdobeRGB] is not available in **AUTO** (, P. 34), **ART** (P. 50), **SCN** (P. 36), **AP** (P. 40), or movie () mode.

## Changing the brightness of highlights and shadows (Highlight&Shadow Control)



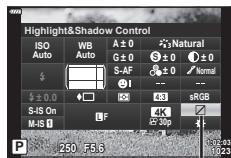

Adjust brightness separately for highlights, mid-tones, and shadows. You gain greater control over exposure than you would with exposure compensation alone. You can selectively make highlights darker or shadows brighter.

- Adjustments may not be available depending on the shooting mode.

- Press the  button in **P/A/S/M** modes.
  - In **Auto**, **ART**, **SCN**, and **AP** modes, the display of the LV super control panel is controlled via  Control Settings] (P. 133).



Highlight&Shadow Control

- Use     to select [Highlight&Shadow Control], then press the  button.

- Press the **INFO** button to choose the desired tone range.

- The tone range changes each time the button is pressed.

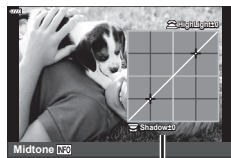

Selected tone range

- Rotate the dials to choose the desired setting.
  - [Hi. & Sh.] selected**  
Adjust highlights using the front dial and shadows using the rear dial.
  - [Midtone] selected**  
Use the front or rear dial.
  - Press and hold the  button to restore the default curve.

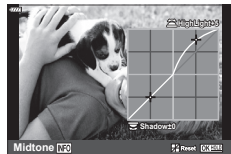

- Press the  button to save changes.
  - You can also save changes by pressing the shutter button halfway.



## Assigning functions to buttons (Button Function)

Other roles can be assigned to buttons in place of their existing functions.

### ■ Customizable Controls

Button	Default
Function	AEL/AFL
Function	(Digital Tele-converter)
Function	REC

To change the function assigned to a button, follow the steps below.

- Press the button in **P/A/S/M** modes.
  - In **Auto**, **ART**, **SCN**, and **AP** modes, the display of the LV super control panel is controlled via [Camera Control Settings] (P. 133).
- Use to select [Button Function], then press the button.
  - The custom menu [Button Function] item will be displayed.
  - [Button Function] can also be accessed from the menus (P. 117, 132).
- Use to highlight the desired button and press .
- Use to highlight the desired function and press the button.
- Press the button again to exit.

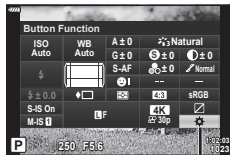

















Button Function







- The functions assigned to the buttons may be unavailable in some modes.
- The options available vary with the current mode.

## ■ Available Roles

 (AEL/AFL)	Press the button to use AE lock or AF lock. The function changes according to the [AEL/AFL] (P. 138) setting. When AEL is selected, press the button once to lock the exposure and display  on the monitor. Press the button again to cancel the lock.
 REC	Press the button to record a movie.
 (Preview)	Aperture is stopped down to the selected value while the button is pressed.
 (One-touch white balance)	Press the shutter button while the button is pressed to acquire a white balance value (P. 84). Highlight the desired number and press the  button to save the value.
 (AF Area Select)	Press the button to choose the AF target (P. 72).
MF	Press the button to select [MF] mode. Press the button again to restore the previously selected AF mode. The focus mode can also be selected by holding the button and rotating a dial.
 (Exposure compensation)	Press the button to adjust exposure compensation. In <b>P</b> , <b>A</b> , <b>S</b> , <b>ART</b> ,  , and movie modes, you can adjust exposure compensation by pressing the button and using  or the front or rear dial to choose the desired value. In <b>M</b> mode, you can adjust shutter speed or aperture by pressing the button and using    or the front or rear dial to choose the desired values.
 (Digital Tele-converter)	Press the button to turn digital zoom [On] or [Off] (P. 119).
 (Magnify)	Press the button to display the magnification frame and press it again to magnify the image. Press and hold the button to cancel magnified display.
Peaking	Press the button to turn on and off the peaking display. When peaking is displayed, histogram and highlight/shadow display are not available (P. 138).
 (Switch  Lock)	Press and hold the button to enable and disable touch screen operation.

## ■ Locking the exposure (AE Lock)

You can lock the exposure by pressing the **AEL/AFL** button. Use this when you want to adjust the focus and exposure separately or when you want to shoot several images at the same exposure.

- If you press the button to which  has been assigned once, the exposure is locked and  is displayed.  "AEL/AFL" (P. 138)
- Press the button to which  has been assigned once again to release the AE Lock.
- The lock will be released if you operate the mode dial, **MENU** button, or  button.

You can zoom in on the display during shooting. For greater precision during focusing, zoom in on the focus area. At higher zoom ratios, you can focus on areas smaller than the standard focus target. You can reposition the focus area as desired during zoom.

- To use Super Spot AF, you must first assign [Q] to a button with Button Function (P. 132).

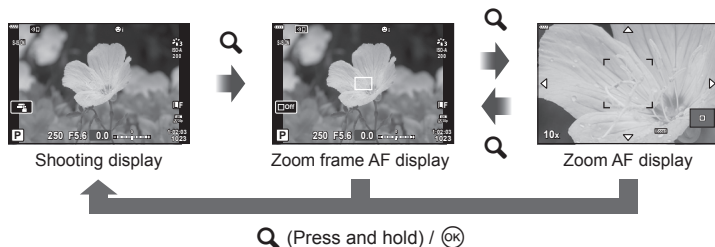

### 1 Press the button to which [Q] (magnify) is assigned.

- The zoom frame will be displayed.
- The frame is displayed in the same position as the target most recently used for autofocus.



### 2 Use $\Delta$ $\nabla$ $\triangleleft$ $\triangleright$ to position the zoom frame.

- To re-center the frame, press and hold the  $\text{OK}$  button.

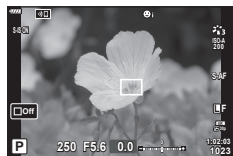

### 3 Adjust the size of the zoom frame to choose the zoom ratio.

- Press the **INFO** button and then use the  $\Delta$   $\nabla$  buttons or the front or rear dial to adjust the size of the zoom frame.
- Press the  $\text{OK}$  button to accept and exit.



#### 4 Press the button to which [Q] is assigned once more.

- The camera will zoom the selected area in to fill the display.
- Use the front or rear dial to zoom in or out.
- You can also scroll the display using the arrow pad ( $\Delta \nabla \triangleleft \triangleright$ ).
- In **M** mode, you can press the **INFO** button during zoom to choose aperture or shutter speed.
- Press the **Q** button to return to the zoom frame.
- Press the **OK** button to end focus zoom.
- You can also end focus zoom by pressing and holding the **Q** button.



Exposure adjustment display for **M** mode

#### 5 Press the shutter button halfway to focus using autofocus.

- Focus zoom applies to the display only. Pictures taken with the camera are not affected.



- Touch controls can be used for focus zoom.  "Shooting with touch screen operations" (P. 32)

# 3 Playback

## Information display during playback

### Playback image information

#### Simplified display

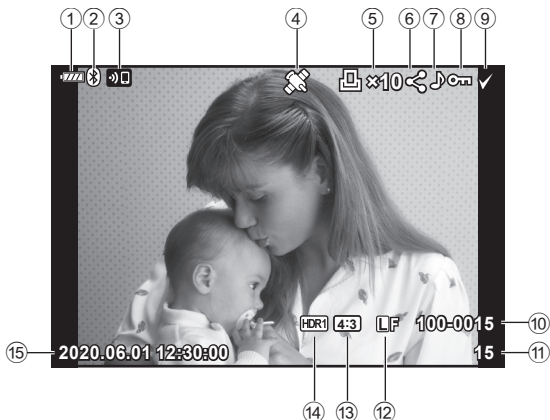

#### Overall display

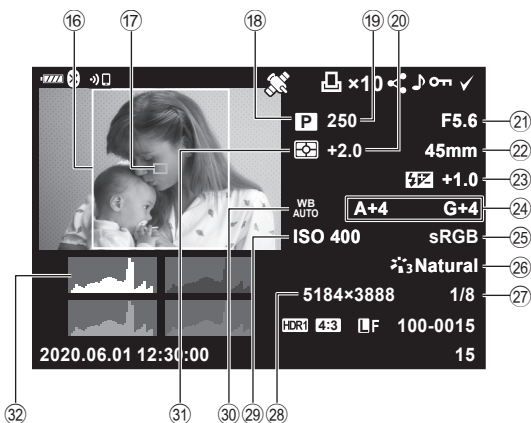

① Battery level.....P. 21	⑯ Aspect border.....P. 86
② <b>Bluetooth</b> ® connection status .....P. 142–150	⑰ AF area pointer.....P. 72
③ Wireless LAN connection.....P. 142–150	⑱ Shooting mode.....P. 29–66
④ Including GPS information.....P. 149	⑲ Shutter speed.....P. 54–60
⑤ Print order Number of prints.....P. 112	⑳ Exposure compensation.....P. 71
⑥ Share order.....P. 111	㉑ Aperture value.....P. 54–60
⑦ Sound record.....P. 113, 127	㉒ Focal length
⑧ Protect.....P. 110	㉓ Flash intensity control.....P. 92
⑨ Image selected.....P. 111	㉔ White balance compensation.....P. 94
⑩ File number.....P. 136	㉕ Color space.....P. 99
⑪ Frame number	㉖ Picture mode.....P. 81, 119
⑫ Image quality.....P. 86	㉗ Compression rate.....P. 141
⑬ Aspect ratio.....P. 86	㉘ Pixel count.....P. 141
⑭ HDR image.....P. 44	㉙ ISO sensitivity.....P. 74
⑮ Date and time.....P. 22	㉚ White balance.....P. 83
	㉛ Metering mode.....P. 95
	㉜ Histogram.....P. 28

## Switching the information display

You can switch the information displayed during playback by pressing the **INFO** button.

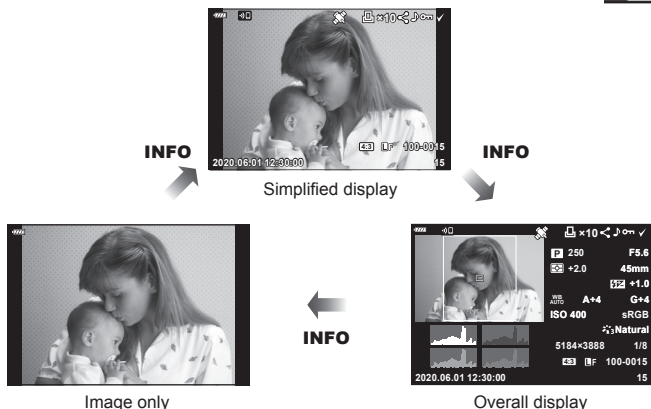
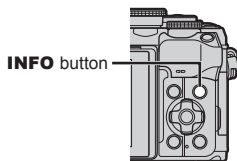









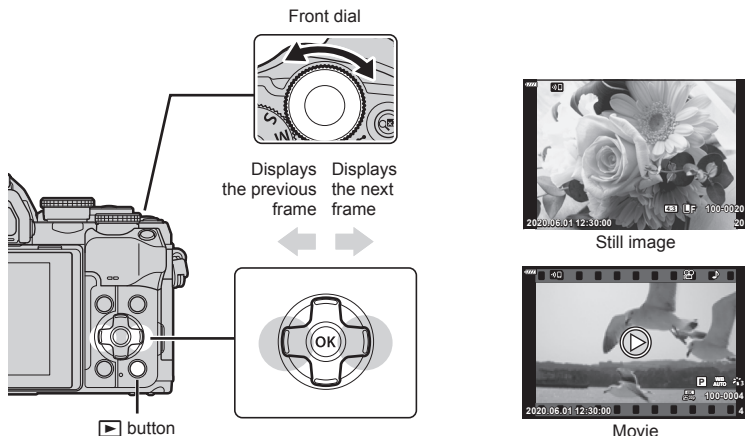











- You can add histogram and highlight & shadow to the information displayed during playback. [Info] (P. 139)

## Viewing photographs and movies





### 1 Press the button.

- A photograph or movie will be displayed.
- Select the desired photograph or movie using the front dial or arrow pad.
- To return to shooting mode, press the shutter button halfway or press the  button.



<b>Rear dial</b>	Zoom in (  ) / Index (  )
<b>Front dial</b>	Previous (  ) / Next (  ) Operation also available during close-up playback.
<b>Arrow pad (   )</b>	Single-frame playback: display the next frame (  ) / display the previous frame (  ) / jump ahead 10 frames (  ) / jump back 10 frames (  ) Close-up playback: Changing the close-up position You can display the next frame (  ) or the previous frame (  ) during close-up playback by pressing the <b>INFO</b> button. Index/calendar playback: Highlight image
<b>INFO button</b>	View image info
<b> () button</b>	Select images for sharing (P. 111)
<b> button</b>	Protect picture (P. 110)
<b> button</b>	Delete picture (P. 110)
<b> button</b>	View menus (in calendar playback, press this button to exit to single-frame playback)

## Finding Pictures Quickly (Index and Calendar Playback)

- In single-frame playback, rotate the rear dial to  () for index playback. Rotate further for calendar playback.
- Turn the rear dial to  () to return to single-frame playback.

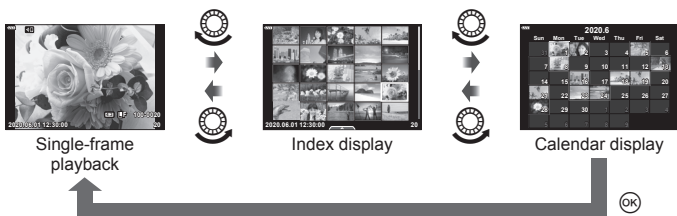





- You can change the number of frames for index display.  [ Settings] (P. 139)



- Touch controls can also be used (P. 115).

## Zooming In (Playback Zoom)



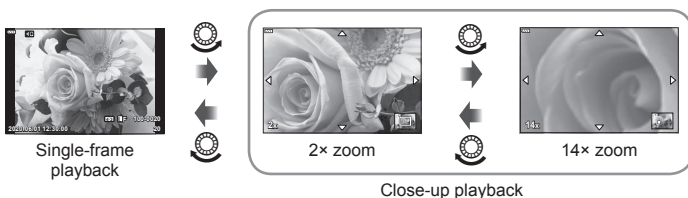

In single-frame playback, turn the rear dial to  () to zoom in. Turn to  () to return to single-frame playback.





- Touch controls can also be used (P. 115).

## Rotating Pictures (Rotate)

Choose whether to rotate photographs.

- 1 Play the photograph back and press the  button.
- 2 Select [Rotate] and press the  button.
- 3 Press  to rotate the image counterclockwise,  to rotate it clockwise; the image rotates each time the button is pressed.
  - Press the  button to save settings and exit.
  - The rotated image is saved in its current orientation.
  - Movies and protected images cannot be rotated.



- The camera can be configured to automatically rotate portrait-orientation pictures during playback.  playback menu > [] (P. 126)  
[Rotate] is not available when [Off] is selected for [].



## Viewing Images as a Slideshow



This function displays images stored on the card one after another.

- 1 Press the **OK** button in the playback display.
- 2 Select **[F2]** and press the **OK** button.

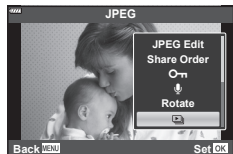

- 3 Adjust settings.

<b>Start</b>	Start the slideshow. Images are displayed in order, starting with the current picture.
<b>BGM</b>	Set [On] or [Off].
<b>Slide</b>	Set the type of data to be played back.
<b>Slide Interval</b>	Choose the length of time each slide is displayed from 2 to 10 seconds.
<b>Movie Interval</b>	Select [Full] to play back full length of each movie clip in the slideshow or [Short] to play back only the opening portion of each movie clip.

- 4 Select [Start] and press the **OK** button.
  - The slideshow will start.
  - Press **Δ**/**∇** during the slideshow to adjust the overall volume of the camera speaker. Press **◀**/**▶** while the volume adjustment indicator is displayed to adjust the balance between the sound recorded with the image or movie and background music.
  - Press the **OK** button to stop the slideshow.

## Watching movies

Select a movie and press the **OK** button to display the playback menu. Select [Play Movie] and press the **OK** button to begin playback. Fast-forward and rewind using **</>**. Press the **OK** button again to pause playback. While playback is paused, use **△** to view the first frame and **▽** to view the last frame. Use **</>** or the front dial to view previous or next frame. Press the **MENU** button to end playback.



- Use **△** **▽** to adjust the volume during movie playback.



- Touch controls can also be used (P. 115).

### Viewing Movies over 4 GB in Size

Long movies may exceed 4 GB in size. Movies over 4 GB in size are recorded over multiple files. The files can be played back as a single movie.

- 1 Press the **▶** button.
  - The most recent picture will be displayed.
- 2 Display a long movie you want to view and press the **OK** button.
 

[Play from Beginning]:	Plays back a split movie all the way through
[Play Movie]:	Plays back files separately
[Delete entire ]:	Deletes all parts of a split movie
[Erase]:	Deletes files separately

- We recommend using the latest version of Olympus Workspace to play back movies on a computer. Before launching the software for the first time, connect the camera to the computer.

## Protecting Pictures

(**On**)

Protect images from accidental deletion. Display the image you want to protect and press the **Qz** button to add **On** to the image (protection icon). Press the **Qz** button again to cancel protection. You can also protect multiple selected images.

"Selecting Multiple Pictures (**On**, Erase Selected, Share Order Selected)" (P. 111)

**On** (protect) icon

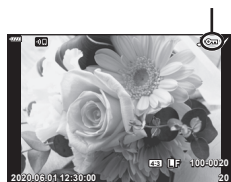

- Formatting the card erases all data including protected images.



## Deleting Pictures

(**Erase**)

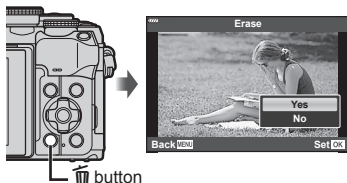
Display an image you want to delete and press the **trash** button. Select [Yes] and press the **OK** button.







## Selecting Pictures for Sharing (Share Order)

You can select images you want to transfer to a smartphone in advance. You can also use OI.Share to browse the images included in the share order. Display the image you want to transfer and press the  (⊙) button to set a share order. A  icon will appear on the image. Press the  (⊙) button again to cancel a share order.

You can select images you want to transfer in advance and set a share order all at once.

- You can set a share order on 200 frames.
- Share orders cannot include RAW images.





If the  (⊙) button is currently assigned a role other than , assign it the  role using the  [Function] option in the custom menus (P. 132).





## Cancelling all share orders (Reset share Order)



Cancel share orders that are set on images.



- 1 Highlight [Reset share Order] in the  playback menu and press the  button.
- 2 Select [Yes] and press the  button.

## Selecting Multiple Pictures (On, Erase Selected, Share Order Selected)

You can select multiple images for , [Erase Selected] or [Share Order Selected].

- To select multiple images, you will first need to select  for  [Function] (P. 132).

Press the  (⊙) button on the index display screen (P. 108) to select an image; a  icon will appear on the image. Press the  (⊙) button again to cancel the selection.

Press the  button to display the menu, and then select from , [Erase Selected] or [Share Order Selected]. This function is also available in single-frame playback.



- Touch controls can also be used (P. 116).

You can select pictures for printing and choose the number of copies and the information printed on each picture. The pictures can be printed at print shops that support the Digital Print Order Format (DPOF). A digital print order is stored on the memory card.

- 1 Press the **OK** button in the playback display.
- 2 Select [**Print Order**] and press the **OK** button.

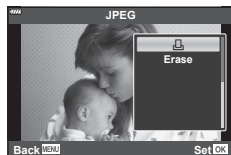

- 3 Select [**Print Order**] or [**Print Order ALL**] and press the **OK** button.

### Individual picture

Press **Left/Right** to select the frame that you want to set as print reservation, then press **Up/Down** to set the number of prints.

- To set print reservation for several pictures, repeat this step. Press the **OK** button when all the desired pictures have been selected.

### All pictures

Select [**Print Order ALL**] and press the **OK** button.

- 4 Select the date and time format and press the **OK** button.

<b>No</b>	The pictures are printed without the date and time.
<b>Date</b>	The pictures are printed with the shooting date.
<b>Time</b>	The pictures are printed with the shooting time.

- When printing images, the setting cannot be changed between the images.

- 5 Select [**Set**] and press the **OK** button.
  - The setting will be applied to the images saved on the card being used for playback.
  - The camera cannot be used to modify print orders created with other devices. Creating a new print order deletes any existing print orders created with other devices.
  - Print orders cannot include RAW images or movies.



- Pictures can also be marked for printing using the **Mark** button. If the **Mark** button is currently assigned a role other than [**Print Order**], assign it the [**Print Order**] role using the [**Function**] option in the custom menus (P. 132).

## Removing all or selected pictures from the print order

You can reset all print reservation data or just the data for selected pictures.

- 1 Press the **OK** button in the playback display.
- 2 Select [**Print Order**] and press the **OK** button.
- 3 Select [**Print Order**] and press the **OK** button.
  - To remove all pictures from the print order, select [Reset] and press the **OK** button. To exit without removing all pictures, select [Keep] and press the **OK** button.
- 4 Press **<>** to select images you wish to remove from the print order.
  - Use **∇** to set the number of prints to 0. Press the **OK** button once you have removed all the desired pictures from the print order.
- 5 Select the date and time format and press the **OK** button.
  - This setting is applied to all frames with print reservation data.
  - The setting will be applied to the images saved on the card being used for playback.
- 6 Select [Set] and press the **OK** button.

## Adding Audio to Pictures



You can record audio using the built-in stereo microphone and add it to pictures. The recorded audio provides a simple replacement for written notes about the pictures.

- Audio recordings can be up to 30 s long.
- 1 Display the image to which you want to add audio and press the **OK** button.
    - Audio recording is not available with protected images.
    - Audio can also be added to pictures using the [Edit] option in the playback menu. Use [Edit] > [Sel. Image] to select the picture, then press the **OK** button and select [**Audio**].
  - 2 Select [**Audio**] and press the **OK** button.
    - To exit without adding audio, select [No].
  - 3 Select [**Start**] and press the **OK** button to begin recording.
  - 4 Press the **OK** button to end recording.
    - Images recorded with audio are indicated by a **♪** icon.

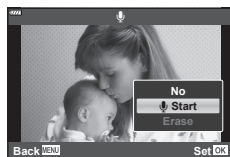
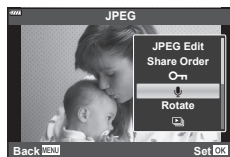

- To delete recorded audio, select [Erase] in Step 3.

## Audio Playback





If an audio recording is available for the current picture, pressing the **OK** button will display audio playback options. Highlight [Play **♪**] and press the **OK** button to begin playback. To end playback, press the **OK** or **MENU** button. During playback, you can press **△** **∇** to raise or lower the volume.







- Audio recordings can also be played back using touch controls (P. 115).

## Scrolling Panoramas

Panoramas made up of multiple images joined together can be viewed in a scrolling display.

- 1 Select a panorama in single-frame playback.
- 2 Turn the rear dial to .
  - Use   to scroll.



- During playback, you can turn the rear dial further to  to zoom in from 2x to 14x or turn it to  to zoom out. Press the  button to return to single-frame playback.
- To view other images at zoom ratios above 2x, press the **INFO** button and then press  . Press the **INFO** button again to re-enable scrolling. You can also view other images using the front dial.



- Touch controls can also be used (P. 115).

## Using the touch screen

You can use the touch screen to manipulate images.

- Do not tap the display with your fingernails or other sharp objects.
- Gloves or monitor covers may interfere with touch screen operation.

### Single-frame playback

#### ■ Displaying the previous or next image

- Slide your finger to the left to view the next image, and right to view the previous image.





#### ■ Magnify

- Lightly tap the screen to display the slider and .
- Slide the bar up or down to zoom in or out.
- Slide your finger to scroll the display area when the picture is zoomed in.



#### ■ Audio playback/Movie playback





- Tap  to start playback.
- To adjust volume during playback, place a finger on the display and slide it up or down.
- Movie playback can be paused by tapping the display. Tap again to resume playback.
- While playback is paused, you can slide the playback position indicator at the bottom of the screen left or right to choose a new starting point.
- Tap  to end playback.



### Index/Calendar playback

Lightly tapping the display during single-frame playback displays a  icon. Tap  to display index playback. Tap  for calendar playback.

#### ■ Displaying the previous or next page

- Slide your finger up to view the next page, and down to view the previous page.
- Tap  or  to switch the number of images displayed.   [Settings] (P. 133)
- Tap  several times to return to single-frame playback.

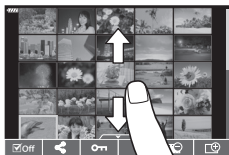





#### ■ Viewing images

- Tap an image to view it full frame.

## Selecting and protecting images

To view the touch menu, lightly tap the display (single-frame playback) or tap the  icon (index playback). You can then perform the desired operation by tapping the icons in the touch menu.



	Select an image. You can select multiple images and delete them collectively.
	Images you want to share with a smartphone can be set.  "Selecting Pictures for Sharing (Share Order)" (P. 111)
	Protects an image.

## Viewing pictures in self-portrait mode

### ■ Displaying the previous or next image

The controls are the same as for single-frame playback (P. 115).

### ■ Magnify

The controls are the same as for single-frame playback (P. 115).

### ■ Audio playback/Movie playback

The controls are the same as for single-frame playback (P. 115).

### ■ Selecting pictures for sharing

- Tap the monitor to display the share icon.
- Tap  to select pictures for sharing.



### ■ Returning to shooting mode

- Tap  to return to shooting mode (P. 69).



- The **INFO** button is disabled in self-portrait mode.



# 4 Menu functions

## Basic menu operations

The menus can be used to customize the camera for ease of use and include shooting and playback options not accessible via the live control, LV super control panel, or the like.

Tab	Tab name	Description
	<b>Shooting Menu 1</b>	Photography-related items. Ready the camera for shooting or access photo settings.
	<b>Shooting Menu 2</b>	
	<b>Video Menu</b>	Items related to movie recording. Adjust basic and custom settings.
	<b>Playback Menu</b>	Playback- and retouch-related items.
	<b>Custom Menu</b>	Items for customizing the camera.
	<b>Setup Menu</b>	Items for setting the clock, choosing a language, and the like.

### Functions that cannot be selected from menus

Some items may not be selectable from the menus when using the arrow pad.

- Items that cannot be set with the current shooting mode.
- Items that cannot be set because of an item that has already been set:  
Settings such as picture mode are unavailable when the mode dial is rotated to .

### 1 Press the **MENU** button to display the menus.

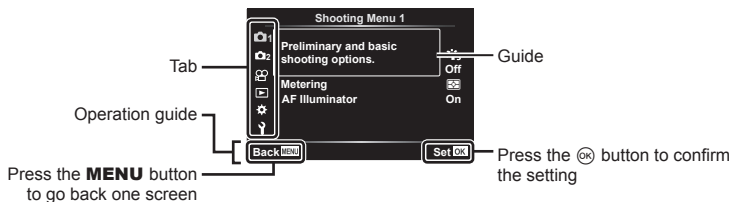

- A guide is displayed in 2 seconds after you select an option.
- Press the **INFO** button to view or hide guides.

### 2 Use $\Delta$ / $\nabla$ to select a tab and press $\triangleright$ .

- The menu group tab appears when the Custom Menu is selected. Use  $\Delta$ / $\nabla$  to select the menu group and press  $\triangleright$ .

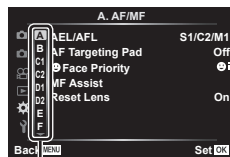

Menu group

- 3 Select an item using  $\Delta$   $\nabla$  and press  $\triangleright$  to display options for the selected item.

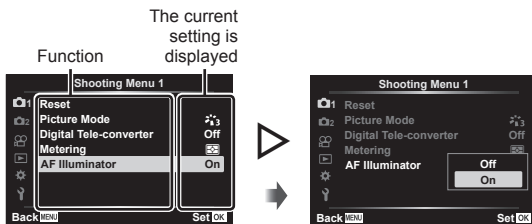

- 4 Use  $\Delta$   $\nabla$  to highlight an option and press the  $\text{OK}$  button to select.
  - Press the **MENU** button repeatedly to exit the menu.



- For the default settings of each option, refer to “Defaults” (P. 169).

## Using Shooting Menu 1/Shooting Menu 2



### Shooting Menu 1

- Reset
- Picture Mode (P. 81, 119)
- Digital Tele-converter (P. 119)
- Metering (P. 95)
- AF Illuminator (P. 119)

### Shooting Menu 2

- Image Stabilizer (P. 93)
- Elec. Zoom Speed (P. 120)
- (P. 92)
- Multiple Exposure (P. 120)
- Intrvl. Sh./Time Lapse (P. 122)
- Silent [ $\heartsuit$ ] Settings (P. 123)
- RC Mode (P. 124)

## Returning to default settings (Reset)

Camera settings can be easily restored to default settings. You can opt to reset almost all settings or only those directly related to photography.

- 1 Select [Reset] in  $\text{MENU}$  Shooting Menu 1 and press  $\triangleright$ .
- 2 Highlight a reset option ([Full] or [Basic]) and press the  $\text{OK}$  button.
  - To reset all settings except the time, date, and a few others, highlight [Full] and press the  $\text{OK}$  button.  $\text{MENU}$  “Defaults” (P. 169)
- 3 Select [Yes] and press the  $\text{OK}$  button.

## Processing options (Picture Mode)

You can make individual adjustments to contrast, sharpness and other parameters in [Picture Mode] (P. 81) settings. Changes to parameters are stored for each picture mode separately.

- 1 Select [Picture Mode] in Shooting Menu 1 and press .
  - The camera will display the picture mode available in the current shooting mode.

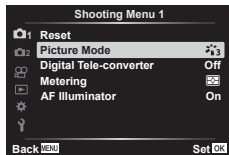

- 2 Select an option with and press the button.
  - Press to set the detailed options for the selected picture mode. Detailed options are not available for some picture modes.
  - Changes to contrast have no effect at settings other than [Normal].

## Digital Zoom (Digital Tele-converter)

This option takes a crop at the center of the frame the same dimensions as the size option currently selected for image quality and zooms it in to fill the display. The zoom ratio increases by about 2x. This allows you to zoom in past the lens' maximum focal length, making it a good choice when you are unable to switch lenses or find it difficult to get any closer to your subject.

- 1 Select [On] for [Digital Tele-converter] in Shooting Menu 1.
- 2 The view in the monitor will be enlarged by a factor of two.
  - The subject will be recorded as it appears in the monitor.

- Digital zoom is not available when panorama, multiple exposure, or keystone compensation is selected.
- When a RAW image taken with [On] selected for [Digital Tele-converter] is displayed, the area visible in the monitor is indicated by a frame.
- AF target drops.
- is displayed on the monitor.

## Improving Focus in Dark Surroundings (AF Illuminator)

The AF illuminator (AF assist lamp) lights to assist the focus operation in dark environments. Select [Off] to disable AF illuminator.

## Choosing a Zoom Speed (Elec. Zoom Speed)

Choose the speed at which electronic zoom lenses can be zoomed in or out using the zoom ring during still photography.

- 1 Highlight [Elec. Zoom Speed] in Shooting Menu 2 and press  $\triangleright$ .
- 2 Select an option with  $\triangle$   $\nabla$  and press the  $\text{OK}$  button.

## Recording multiple exposures in a single image (Multiple Exposure)

Take two shots and combine them into a single picture. Alternatively, you can take a shot and combine it with an existing picture stored on the memory card.

The combined image is recorded at current image quality settings. Only RAW pictures can be selected for multiple exposures that include an existing image.

If you record a multiple exposure with RAW selected for [Elec. Zoom Speed], you can then select it for subsequent multiple exposures using [Overlay], allowing you to create multiple exposures combining three or more photographs.

- This option is available in **P**, **A**, **S**, and **M** modes.

- 1 Select [Multiple Exposure] in Shooting Menu 2 and press  $\triangleright$ .
- 2 Use  $\triangle$   $\nabla$  to select the item and press  $\triangleright$ .
  - Use  $\triangle$   $\nabla$  to select the setting and press the  $\text{OK}$  button.

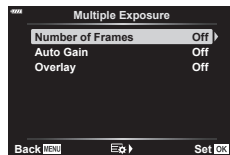

<b>Number of Frames</b>	[Off]: Do not create additional multiple exposures. [2f]: Create a multiple exposure from 2 pictures.
<b>Auto Gain</b>	[On]: Halve the brightness of each picture in the multiple exposure. [Off]: Do not adjust brightness the brightness of the pictures in the multiple exposure.
<b>Overlay</b>	[On]: Shoot a multiple exposure that includes an existing RAW image stored on the memory card. [Off]: Create a multiple exposure from the next 2 pictures taken. <ul style="list-style-type: none"><li>• [Overlay] is only available when [2f] is selected for [Number of Frames].</li></ul>

- 3 If [On] is selected for [Overlay], you will be prompted to choose a picture for the multiple exposure.
  - Highlight a picture using the arrow pad ( $\triangle$   $\nabla$   $\triangleleft$   $\triangleright$ ) and press the  $\text{OK}$  button.
  - Only RAW images can be selected.

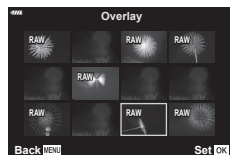



- 4 Press the  $\text{OK}$  button in the multiple exposure menu to save the selected settings.
  - The shooting menu will be displayed.

## 5 Press the **MENU** button to exit the menus.

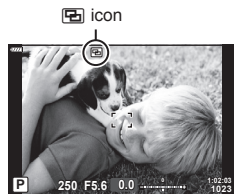

- A  icon will be displayed.
- If [Overlay] is selected, the chosen photograph will be visible superimposed on the view through the lens.



## 6 Take pictures.

- The first shot (or if [Overlay] is selected, the previously-chosen photograph) will be visible superimposed on the view through the lens as you compose the next shot.
- The  icon turns green.
- Normally, a multiple exposure will be created after the second shot is taken.
- Pressing the  button allows you to retake the first shot.
- If [On] is selected for [Overlay], you can take additional pictures that will be overlaid on the previously-chosen photograph.

## 7 Press the **MENU** button or press the button to end multiple exposure photography.



- If you end multiple exposure photography by pressing the **MENU** button, [Off] will be selected for [Number of Frames] in the multiple exposure menu.
- The  icon clears from the display when multiple exposure photography ends.
- The camera will not enter sleep mode during multiple exposure photography.
- Pictures taken with other cameras cannot be used for multiple exposures.
- The RAW pictures listed in the image-selection display when [On] is selected for [Overlay] are those processed using the settings in effect at the time the photograph was taken.
- The image-selection display for [Overlay] shows the RAW copies of photographs taken with RAW + JPEG selected for image quality.
- Exit multiple exposure mode before adjusting shooting settings. Some settings cannot be adjusted while multiple exposure mode is in effect.
- Performing any of the following operations after the first shot is taken ends multiple exposure photography:
  - turning the camera off, pressing the  or **MENU** button, choosing a different shooting mode, or connecting cables of any type. Multiple exposure is also canceled when the battery is exhausted.
- This function cannot be used with interval-timer photography.
- Pictures taken with RAW selected for  can also be overlaid during playback.

## Shooting automatically with a fixed interval (Intrvl. Sh./Time Lapse)

You can set the camera to shoot automatically with a set time lapse. The shot frames can also be recorded as into a single movie. This setting is only available in **P/A/S/M** modes.

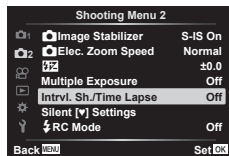
- 1 Highlight [Intrvl. Sh./Time Lapse] in  Shooting Menu 2 and press .



- 2 Select [On] and press the .
- 3 Adjust the following settings and press the .

<b>Number of Frames</b>	Sets the number of frames to be shot.
<b>Start Waiting Time</b>	Sets waiting time before starting to shoot.
<b>Interval Length</b>	Sets interval between shots after shooting starts.
<b>Time Lapse Movie</b>	Sets recording format of frame sequence. [Off]: Records each frame as a still picture. [On]: Records each frame as a still picture and generates a single movie from the frame sequence.
<b>Movie Settings</b>	[Movie Resolution]: Choose a size for time lapse movies. [Frame Rate]: Choose a frame rate for time lapse movies.

- The starting and ending times shown in the display are intended as a guide only. The actual times may vary with shooting conditions.

- 4 The [Off]/[On] options will be displayed once more; confirm that [On] is highlighted and press the  button again.
- 5 Shoot.

- Frames are shot even if the image is not in focus after AF. If you wish to fix the focus position, shoot in MF.
- [Rec View] (P. 130) operates for 0.5 seconds.
- If either of the time before shooting, or shooting interval is set to 1 minute 31 seconds or longer, the monitor and camera power will turn off after 1 minute. 10 seconds before shooting, the power will automatically turn on again. When the monitor is off, press the shutter button to turn it on again.
- If the AF mode (P. 84) is set to [C-AF] or [C-AF+TR], it is automatically changed to [S-AF].
- Touch operations are disabled during time lapse shooting.
- Bulb, time, and composite photography are not available during time lapse photography.
- This function cannot be used with multiple exposure.
- The flash will not work if the flash charging time is longer than the interval between shots.
- If any of still pictures are not recorded correctly, the time lapse movie will not be generated.
- If there is insufficient space on the card, the time lapse movie will not be recorded.
- The following cancel time-lapse shooting:  
using the mode dial, **MENU** button,  button, or lens-release button; connecting a USB cable; turning the camera off
- If there is not enough charge left on the battery, the shooting may end partway through. Make sure the battery is charged enough before shooting.
- Movies recorded with [4K] selected for [Movie Settings] > [Movie Resolution] may not display on some computer systems. More information is available on the OLYMPUS website.

## Silent-Mode Options (Silent [♥] Settings)

Choose the following options when shooting in the silent mode (P. 78):





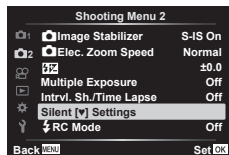

- Noise reduction on/off
- Whether or not to enable , [AF Illuminator], and [Flash Mode]

**1** Highlight [Silent [♥] Settings] in  Shooting Menu 2 and press .



**2** Select an option with   and press .

### 3 Adjust the following settings and press the button.

<b>Noise Reduction</b> 	[Auto]: Reduce noise in long exposures when shooting in the silent mode (P. 78). The sound of the shutter may be audible when noise reduction is active. [Off]: Noise reduction off.
<b> (Beep sound)</b>	[Allow]: Uses the settings currently selected for  in  Custom Menu  (P. 133). [Not Allow]: Turns off the beep sound when shooting in the silent mode.
<b>AF Illuminator</b>	[Allow]: Uses the settings currently selected for [AF Illuminator] in  Shooting Menu 1 (P. 119). [Not Allow]: Disables the AF Illuminator when shooting in the silent mode.
<b>Flash Mode</b>	[Allow]: Uses the current flash settings (P. 75). [Not Allow]: Disables the flash when shooting in the silent mode.

### Wireless remote control flash photography (RC Mode)

You can take wireless flash photographs using the built-in flash and a special flash with a remote control function.  "Wireless remote control flash photography" (P. 158)



## Using the Video Menu

Movie recording functions are set in the Video Menu.



Option	Description	
<b>Movie</b>	[Off]: Record movies without sound. [On]: Record movies with sound. [On ]: Record movies with sound; wind noise reduction enabled.	—
<b>Recording Volume</b>	Adjust the sensitivity of the built-in microphone. Adjust the sensitivity using $\Delta$ $\nabla$ while checking the peak sound level picked up by the microphone over the previous few seconds.	—
<b>AF Mode</b>	Choose the AF mode for movie recording.	84
<b>Image Stabilizer</b>	Sets image stabilization for movie recording.	93
<b>Elec. Zoom Speed</b>	Choose the speed at which electronic zoom lenses can be zoomed in or out during movie recording.	—
<b>Video Frame Rate</b>	Choose the frame rate for movie recording. • When shooting movies that will be viewed on a television, choose a frame rate that matches the video standard used in the device, as otherwise the movie may not play back smoothly. Video standards vary by country or region: some use NTSC, others PAL. - When shooting for display on NTSC devices, choose 60p (30p) - When shooting for display on PAL devices, choose 50p (25p)	87
<b>Video Bit Rate</b>	Choose the compression ratio for movie recording.	87

- Operation sounds of the lens and camera may be recorded in a movie. To prevent it from recording, reduce the operation sounds by setting [AF Mode] to [S-AF] or [MF], or by minimizing the button operations of the camera.
- Sound cannot be recorded in <sup>ART</sup> (Diorama) mode.
- When [Movie ] is set to [Off], is displayed.

## Using the Playback Menu

### Playback Menu

 (P. 109)



Edit

Print Order (P. 112)

Reset Protect (P. 129)

Reset share Order (P. 111)

Device Connection (P. 143)

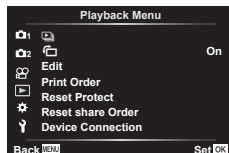

### Automatically Rotating Portrait-Orientation Pictures for Playback











If set to [On], images in portrait orientation are automatically rotated to be displayed in the correct orientation on the playback display.

### Retouching Pictures



Create retouched copies of pictures. In the case of RAW pictures, you can adjust the settings such as art filters, which are usually applied when the pictures are taken. With JPEG pictures, you can make simple edits such as cropping and resizing.

- 1 Select [Edit] in the  Playback Menu and press .
- 2 Use   to select [Sel. Image] and press the  button.
- 3 Use   to select the image to be edited and press the  button.
  - [RAW Data Edit] is displayed if a RAW image is selected, and [JPEG Edit] if a JPEG image is selected. For images recorded in RAW+JPEG format, both [RAW Data Edit] and [JPEG Edit] are displayed. Select the desired option from them.
- 4 Select [RAW Data Edit] or [JPEG Edit] and press the  button.

#### RAW Data Edit



Creates a JPEG copy of a RAW image according to the selected settings.





#### Current

The JPEG copy is processed using the current camera settings. Adjust the camera settings before choosing this option. Some settings such as exposure compensation are not applied.

#### ART BKT

The camera creates multiple JPEG copies of each image, one for each art filter selected. Select one or more filters and apply them to one or more images.















<b>JPEG Edit</b>	<p>The [JPEG Edit] menu contains the following options.</p> <p><b>Shadow Adj.</b> Brighten back-lit subjects.</p> <p><b>Red-eye Fix</b> Reduce "red-eye" in pictures taken with a flash.</p> <p> Crop pictures. Size the crop with the front or rear dial and position it with the arrow pad.</p> <p><b>Aspect</b> Change the aspect ratio from the standard 4:3 to [3:2], [16:9], [1:1], or [3:4]. After choosing an aspect ratio, use the arrow pad to position the crop.</p> <p><b>Black &amp; White</b> Create a black-and-white copy of the current picture.</p> <p><b>Sepia</b> Create a sepia copy of the current picture.</p> <p><b>Saturation</b> Adjust the vividness of colors. The results can be previewed in the display.</p> <p> Create a resized copy 1280 × 960, 640 × 480, or 320 × 240 pixels in size. Pictures with an aspect ratio other than the standard 4:3 are resized to dimensions as close as possible to the selected option.</p> <p><b>e-Portrait</b> Smooth complexions. The desired effect may not be achieved if no faces are detected.</p>
------------------	--

- 5** When the settings are complete, press the  button.
    - The settings are applied to the image.
  - 6** Select [Yes] and press the  button.
    - The edited image is stored in the card.
- Red-eye correction may not work depending on the image.
  - Editing of a JPEG image is not possible in the following cases:
    - When an image is processed on a PC, when there is not enough space in the card memory, or when an image is recorded on another camera.
  - The image cannot be resized () to the larger size than the original size.
  - Some images can not be resized.
  - [] (trimming) and [Aspect] can only be used to edit images with an aspect ratio of 4:3 (standard).

### **Audio recording**

Audio can be added to still images (up to 30 sec. long).  
This is the same function as [] during playback (P. 113).

Overlay existing RAW photos and to create a new picture. Up to 3 pictures can be included in the overlay.

- 1 Select [Edit] in the  Playback Menu and press .
- 2 Use   to select [Image Overlay] and press the  button.
- 3 Select the number of images to be overlaid and press the  button.
- 4 Use   to select the RAW images and press the  button to add them to the overlay.
  - The overlaid image will be displayed if images of the number specified in step 3 are selected.
- 5 Adjust the gain for each image to be overlaid.
  - Use   to select an image and   to adjust gain.
  - Gain can be adjusted in the range 0.1–2.0. Check the results in the monitor.
- 6 Press the  button to display the confirmation dialog. Select [Yes] and press the  button.

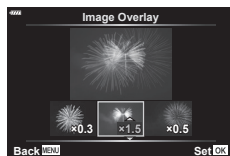
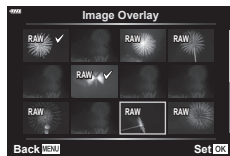

















- To overlay 4 or more frames, save the overlay image as a RAW file and use [Image Overlay] repeatedly.

## Creating Movie Stills

## (In-Movie Image Capture)

Save a still copy of a selected frame.





















- This option is available only with [4K] movies recorded with the camera.

- 1 Select [Edit] in the  Playback Menu and press .
- 2 Use   to select [Sel. Image] and press the  button.
- 3 Use   to select a movie and press the  button.
- 4 Select [Movie Edit] and press the  button.
- 5 Use   to select [In-Movie Image Capture] and press the  button.
- 6 Use   to select a frame to be saved as a still image and press the  button.
  - Use   or to skip multiple frames.
  - The date of recording of the still may differ from that of the original movie.

## Trimming movies (Movie Trimming)



Cut selected footage from movies. Movies can be trimmed repeatedly to create files containing only footage you want to preserve.

- This option is available only with movies recorded with the camera.

- 1 Select [Edit] in the  Playback Menu and press .
- 2 Use   to select [Sel. Image] and press the  button.
- 3 Use   to select a movie and press the  button.
- 4 Select [Movie Edit] and press the  button.
- 5 Use   to select [Movie Trimming] and press the  button.
- 6 Select [Overwrite] or [New File] and press the  button.
  - If the image is protected, you cannot select [Overwrite].
- 7 Choose whether the section to be deleted begins with the first frame or ends with the last frame, using   to highlight the desired option and pressing the  button to select.
- 8 Use   to choose the section to be deleted.
  - The section to be deleted is shown in red.
- 9 Press the  button.
- 10 Select [Yes] and press the  button.
  - The date of recording of the still may differ from that of the original movie.

## Removing Protection from All Pictures (Reset Protect)



Protections of multiple images can be canceled at a time.

- 1 Select [Reset Protect] in the  Playback Menu and press .
- 2 Select [Yes] and press the  button.

## Using the setup menu

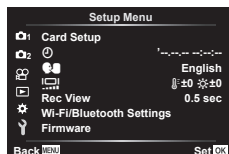
Adjust basic camera settings. Examples include language selection and monitor brightness. The setup menu also contains options used during the initial setup process.





Option	Description	
<b>Card Setup</b>	Format the card and delete all images.	131
<b>(Date/time setting)</b>	Set the camera clock.	22
<b>(Changing the display language)</b>	Choose a language for camera menus and guides.	131
<b>(Monitor brightness adjustment)</b>	<p>You can adjust the brightness and color temperature of the monitor. Use &lt;Left&gt;&lt;Right&gt; to highlight (color temperature) or (brightness) and <math>\Delta</math> <math>\nabla</math> to adjust the value.</p>  <p>Press the <b>INFO</b> button to switch the saturation of the monitor between [Natural] and [Vivid] settings.</p>	—
<b>Rec View</b>	<p>Sets whether to display the captured image on the monitor after shooting, and the length of time for the display. This is useful for a brief check of the picture you have taken. You can shoot the next shot by pressing the shutter button halfway even while the captured image is displayed on the monitor.</p> <p>[0.3sec]–[20sec]: Sets the length of time (seconds) to display the captured image on the monitor.</p> <p>[Off]: The captured image is not displayed on the monitor.</p> <p>[Auto ]: Displays the captured image, and then switches to playback mode. This is useful for erasing a picture after checking it.</p>	—
<b>Wi-Fi/Bluetooth Settings</b>	Adjust settings for connection to Wi-Fi/ <b>Bluetooth</b> compatible smartphones using the camera's wireless function.	145, 149, 150
<b>Firmware</b>	View the versions of the firmware for the camera and any lenses or other peripherals currently connected. You may need this information when contacting customer support or performing firmware updates.	—

## Formatting the card (Card Setup)

Cards must be formatted with this camera before first use or after being used with other cameras or computers.

All data stored on the card, including protected images, is erased when the card is formatted.

When formatting a used card, confirm there are no images that you still want to keep on the card.  “Usable cards” (P. 154)

- 1 Select [Card Setup] in the  Setup Menu and press .

- If there is data on the card, menu items appear. Select [Format] and press the  button.

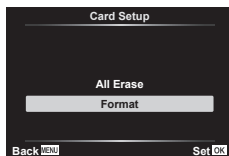

- 2 Select [Yes] and press the  button.

- Formatting is performed.



## Deleting all images (Card Setup)

All images on a card can be deleted at a time. Protected images are not deleted.

- 1 Select [Card Setup] in the  Setup Menu and press .

- 2 Select [All Erase] and press the  button.

- 3 Select [Yes] and press the  button.

- All images are deleted.

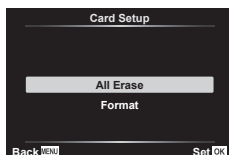





## Choosing a language ( )

Choose a language for camera menus and guides.

- 1 Select  in the  Setup Menu and press .

- 2 Highlight the desired language using the front or rear dial or the     buttons on the arrow pad.

- The language-selection dialog has two pages of options. Use the front or rear dial or the     buttons on the arrow pad to move the cursor between pages.



- 3 Press the  button when the desired language is highlighted.



## Using the custom menu

Camera settings can be customized using the  Custom Menu.

### Custom Menu

- A** AF/MF
- B** Button/Dial
- C1/C2** Disp./PC (P. 133)
- D1/D2** Exp/ISO/BULB (P. 134)
- E**  Custom (P. 135)
- F**  /WB/Color (P. 135)
- G** Record (P. 136)
- H** EVF (P. 137)
- I**  Utility (P. 137)

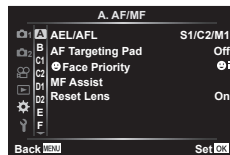





### **A** AF/MF

MENU →  → **A**

Option	Description	
<b>AEL/AFL</b>	Customize AF and AE lock.	138
<b>AF Targeting Pad</b>	If [On] is selected, the AF target can be positioned by tapping the monitor during viewfinder photography. Tap the monitor and slide your finger to position the AF target. <ul style="list-style-type: none"> <li>• When set to [On], drag operation can be disabled or enabled by double-tapping the monitor.</li> <li>• [AF Targeting Pad] can also be used with zoom frame AF (P. 103).</li> </ul>	—
<b>Face Priority</b>	You can select the face priority or eye priority AF mode.	73
<b>MF Assist</b>	When set to [On], you can automatically switch to zoom or peaking in manual focus mode by rotating the focus ring.	138
<b>Reset Lens</b>	When set to [Off], the focus position of the lens is not reset even when the power is turned off. When set to [On], the focus of power zoom lenses is also reset.	—

### **B** Button/Dial

MENU →  → **B**

Option	Description	
<b>Button Function</b>	Choose the function assigned to the selected button.	101
<b>Function</b>	Choose the role played by the  button during playback. <ul style="list-style-type: none"> <li>[]: Mark pictures for sharing.</li> <li>[]: Select multiple pictures.</li> <li>[]: Mark pictures for printing at a later date. The number of copies is set to 1. The date is not printed.</li> </ul>	111, 112
<b>Dial Function</b>	You can change the function of the front dial and rear dial.	—



Option	Description	
<b>Control Settings</b>	For each shooting mode except movie, choose whether pressing the  button displays live controls or LV super controls.	79, 80
/Info Settings	Choose the information displayed when the <b>INFO</b> button is pressed. [▶] Info: Choose the information displayed in full frame playback. [LV-Info]: Choose the information displayed when the camera is in shooting mode. [Settings] Settings: Choose the information displayed in index and calendar playback.	139
<b>Live View Boost</b>	Shoot while checking the subject even under low-light conditions. [Off]: Preview exposure in live view. Exposure can be previewed before shooting. • The setting automatically switches to [On2] during bulb or time photography. • The setting automatically switches to [On1] during zoom or preview display. [On1]: Exposure preview disabled; brightness is adjusted for ease of viewing. The brightness of the preview differs from the final photograph. [On2]: As for [On1] but brighter. Choose when framing shots of the night sky or the like. • The brightness of the preview differs from the final photograph. Subject motion may also appear slightly jerky.	—
<b>Flicker Reduction</b>	Reduce the effects of flicker under some kinds of lighting, including fluorescent lamps. When flicker is not reduced by the [Auto] setting, set to [50Hz] or [60Hz] in accordance with the commercial power frequency of the region where the camera is used.	—
<b>Displayed Grid</b>	Select  to display a grid on the monitor.	—
<b>Peaking Color</b>	Choose the color of the outlines (red, yellow, white, or black) in the focus peaking display.	138

Option	Description	
(Beep sound)	When set to [Off], you can turn off the beep sound that is emitted when the focus locks by pressing the shutter button.	—
<b>HDMI</b>	[Output Size]: Selecting the digital video signal format for connecting to a TV via an HDMI cable. [HDMI Control]: Select [On] to allow the camera to be operated using remotes for TVs that support HDMI control. This option takes effect when pictures are displayed on a TV.	140
<b>USB Mode</b>	Choose a mode for connecting the camera to a computer. Choose [Auto] to display USB mode options every time the camera is connected.	—

Option	Description	
<b>Exposure Shift</b>	Adjust correct exposure separately for each metering mode. <ul style="list-style-type: none"> <li>This reduces the number of exposure compensation options available in the selected direction.</li> <li>The effects are not visible in the monitor. To make normal adjustments to the exposure, perform exposure compensation (P. 71).</li> </ul>	—
<b>ISO-Auto Set</b>	Choose the upper limit and default value used for ISO sensitivity when [Auto] is selected for ISO. [Upper Limit]: Choose the upper limit for auto ISO sensitivity selection. [Default]: Choose the default value for auto ISO sensitivity selection.	—
<b>Noise Filter</b>	Choose the amount of noise reduction performed at high ISO sensitivities.	—
<b>Noise Reduct.</b>	This function reduces the noise that is generated during long exposures. [Auto]: Noise reduction is performed at slow shutter speeds, or when the internal temperature of the camera has risen. [On]: Noise reduction is performed with every shot. [Off]: Noise reduction off. <ul style="list-style-type: none"> <li>The time required for noise reduction is shown in the display.</li> <li>[Off] is selected automatically during sequential shooting.</li> <li>This function may not work effectively with some shooting conditions or subjects.</li> <li>When shooting in the silent mode, priority is given to the [Noise Reduction [♥]] setting in the [Silent [♥] Settings] menu (P. 123).</li> </ul>	62



Option	Description	
<b>Bulb/Time Timer*</b>	Choose the maximum exposure for bulb and time photography.	61
<b>Live Bulb</b>	Choose the display interval during shooting. The number of update times is limited. The frequency drops at high ISO sensitivities. Tap the monitor or press the shutter button halfway to refresh the display. Choose [Off] to disable the display.	
<b>Live Time*</b>	Choose the display interval during shooting. The number of update times is limited. The frequency drops at high ISO sensitivities. Tap the monitor or press the shutter button halfway to refresh the display. Choose [Off] to disable the display.	63
<b>Composite Settings*</b>	Set an exposure time to be the reference in composite photography.	

\* Settings for bulb/time maximum exposure and live composite photography apply only in mode **M**. These do not apply when [Live Composite] or [Live Time] is selected from the AP mode menu.

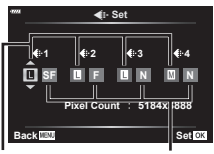
Option	Description	Icon
⚡ X-Sync.	Choose the shutter speed used when the flash fires.	141
⚡ Slow Limit	Choose the slowest shutter speed available when a flash is used.	141
⊞+⊞	When set to [On], the exposure compensation value is added to the flash compensation value.	71, 92
⚡+WB	Adjust white balance for use with a flash.	—

Option	Description	Icon
← Set	<p>You can select the JPEG image quality mode from combinations of three image sizes and three compression rates.</p> <ol style="list-style-type: none"> <li>Use ◀▶ to select a combination ([←:1] – [←:4]) and use ▲▼ to change.</li> <li>Press the OK button.</li> </ol> <div style="text-align: center;">  <p>The screenshot shows a menu titled '← Set' with four options: 1, 2, 3, and 4. Below the options, it displays 'Pixel Count : 5184x1888'. At the bottom, there are 'Back' and 'Set' buttons. Arrows indicate that options 1-4 are grouped under 'Image size' and 'Compression rate'.</p> </div>	86, 141
WB	Set the white balance. You can also fine-tune the white balance for each mode.	83, 94
WB AUTO Keep Warm Color	Select [On] to preserve “warm” colors in pictures taken under incandescent lighting.	—
Color Space	You can select a format to ensure that colors are correctly reproduced when shot images are regenerated on a monitor or using a printer.	99

Option	Description	👉
<p><b>File Name</b></p>	<p>[Auto]: Even when a new card is inserted, the file numbers are retained from the previous card. File numbering continues from the last number used or from the highest number available on the card.</p> <p>[Reset]: When you insert a new card, the folder numbers starts at 100 and the file name starts at 0001. If a card containing images is inserted, the file numbers start at the number following the highest file number on the card.</p>	<p>—</p>
<p><b>Edit Filename</b></p>	<p>Choose how image files are named by editing the portion of the filename highlighted below in gray.</p> <p>sRGB: Pmdd0000.jpg _____ Pmdd                      Adobe RGB: _mdd0000.jpg _____ mdd</p> <div style="border: 1px solid gray; padding: 5px;"> <ol style="list-style-type: none"> <li>1) Highlight [sRGB] or [AdobeRGB] and press <b>▷</b>.</li> <li>2) Use <b>&lt;▷</b> to move the cursor and <b>△ ▽</b> to edit the highlighted character.</li> <li>3) Repeat Step 2 as necessary to create the desired filename and then press <b>OK</b>.</li> </ol> </div>	<p>—</p>
<p><b>Copyright Settings*</b></p>	<p>Add the names of the photographer and copyright holder to new photographs. Names can be up to 63 characters long.</p> <p>[Copyright Info.]: Select [On] to include the names of the photographer and copyright holder in the Exif data for new photographs.</p> <p>[Artist Name]: Enter the name of the photographer.</p> <p>[Copyright Name]: Enter the name of the copyright holder.</p> <ol style="list-style-type: none"> <li>1) Select characters from ① and press the <b>OK</b> button. The selected characters appear in ②.</li> <li>2) Repeat Step 1 to complete the name, then highlight [END] and press the <b>OK</b> button.                             <ul style="list-style-type: none"> <li>• To delete a character, press the <b>INFO</b> button to place the cursor in the name area ②, highlight the character, and press <b>INFO</b>.</li> </ul> </li> </ol> <div style="text-align: center;">  </div> <p>* OLYMPUS does not accept liability for damages arising from disputes involving the use of [Copyright Settings]. Use at your own risk.</p>	<p>—</p>

Option	Description	
<b>EVF Auto Switch</b>	If [Off] is selected, the viewfinder will not turn on when you put your eye to the viewfinder. Use the  button to choose the display.	—
<b>EVF Adjust</b>	Adjust viewfinder brightness and hue. Brightness is automatically adjusted when [EVF Auto Luminance] is set to [On]. The contrast of the information display is also adjusted automatically.	—

Option	Description	
<b>Pixel Mapping</b>	The pixel mapping feature allows the camera to check and adjust the image pickup device and image processing functions.	163
<b>Level Adjust</b>	You can calibrate the angle of the level gauge. [Reset]: Resets adjusted values to the default settings. [Adjust]: Sets the current camera orientation as the 0 position.	—
<b>Touchscreen Settings</b>	Activate the touch screen. Choose [Off] to disable the touch screen.	—
<b>Sleep</b>	The camera will enter sleep (energy saving) mode if no operations are performed for the selected period. The camera can be reactivated by pressing the shutter button halfway.	—
<b>Certification</b>	Display certification icons.	—

## AEL/AFL

MENU → → **A** → [AEL/AFL]

Autofocus and metering can be performed by pressing the **AEL/AFL** button. Choose a mode for each focus mode.

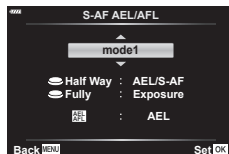

### Assignments of AEL/AFL function

Mode		Shutter button pressed				AEL/AFL button	
		Halfway		All the way down		Kept pressed	
		AF	AE	AF	AE	AF	AE
S-AF	mode1	S-AF	Locked	–	–	–	Locked
	mode2	S-AF	–	–	Locked	–	Locked
	mode3	–	Locked	–	–	S-AF	–
C-AF	mode1	C-AF start	Locked	Ends	–	–	Locked
	mode2	C-AF start	–	Ends	Locked	–	Locked
	mode3	–	Locked	Ends	–	C-AF start	–
	mode4	–	–	Ends	Locked	C-AF start	–
MF	mode1	–	Locked	–	–	–	Locked
	mode2	–	–	–	Locked	–	Locked
	mode3	–	Locked	–	–	S-AF	–

## Manual Focus Assist (MF Assist)

MENU → → **A** → [MF Assist]

This is a focus assist function for MF. When the focus ring is rotated, the edge of the subject is enhanced or a portion of the screen display is magnified. When you stop operating the focus ring, the screen returns to the original display.

<b>Magnify</b>	Magnifies a portion of the screen. The portion to be magnified can be set in advance using AF target.  "Setting the AF target" (P. 72)
<b>Peaking</b>	Displays clearly defined outlines with edge enhancement. You can choose the color of the outlines.  [Peaking Color] (P. 133)

- When Peaking is in use, the edges of small subjects tend to be enhanced more strongly. This is no guarantee of accurate focusing.



- [Peaking] can be displayed using button operations. The display is switched every time the button is pressed. Assign the switching function to one of the buttons in advance using Button Function (P. 101).

## Adding information displays

MENU → ⚙ → [i] → [Info Settings]

### ▶ Info (Playback information displays)

Use [▶] Info to add the following playback information displays. The added displays are displayed by repeatedly pressing the **INFO** button during playback. You can also choose to not show displays that appear at the default setting.



Histogram display



Highlight & Shadow display

- The Highlight & Shadow display shows overexposed areas in red, underexposed areas in blue.



### LV-Info (Shooting information displays)

The histogram, Highlight & Shadow, and level gauge displays can be added to [LV-Info]. Choose [Custom 1] or [Custom 2] and select the displays you wish to add. The added displays are displayed by repeatedly pressing the **INFO** button during shooting. You can also choose to not show displays that appear at the default setting.



### ⊞ Settings (Index/calendar display)

You can change the number of frames to be displayed on the index display and set to not display the screens that are set to be displayed by default with [⊞ Settings]. Screens with a check can be selected on the playback screen using the rear dial.

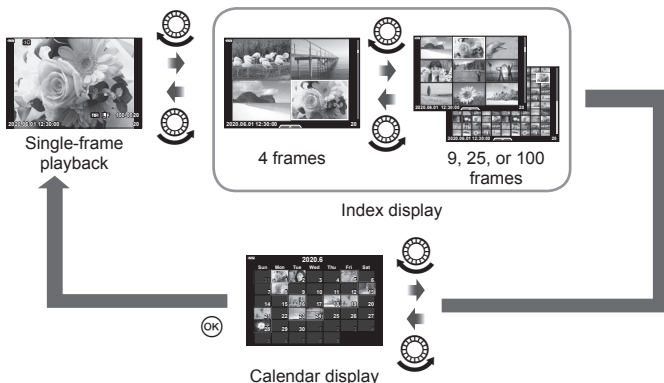
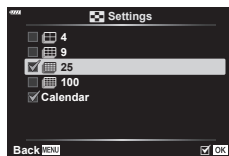

## MENU → ⚙ → [HDMI]

Use the separately sold cable with the camera to playback recorded images on your TV. This function is available during shooting. Connect the camera to an HD TV using an HDMI cable to view high-quality images on a TV screen.

- 1 Turn the camera off and connect it to the TV.

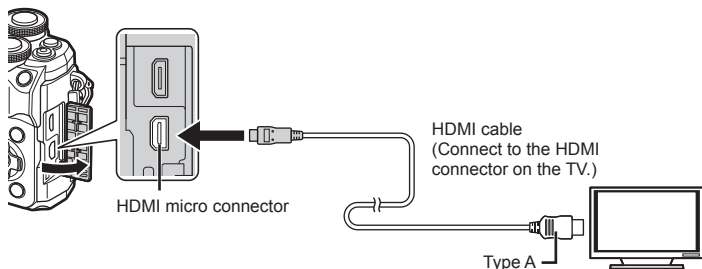

- The location of the HDMI connector varies with the TV. For details, refer to the TV's instruction manual.

- 2 Turn the camera on.

- 3 Switch the input source of the TV.

- The camera monitor turns off when it is connected via an HDMI cable.
- For details on changing the input source of the TV, refer to the TV's instruction manual.
- Depending on the TV's settings, the displayed images and information may become cropped.
- If the camera is connected via an HDMI cable, you will be able to choose the digital video signal type. Choose a format that matches the input format selected with the TV.

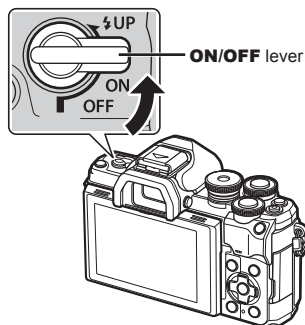

<b>4K</b>	Priority is given to 4K HDMI output.
<b>1080p</b>	Priority is given to 1080p HDMI output.
<b>720p</b>	Priority is given to 720p HDMI output.
<b>480p/576p</b>	480p/576p HDMI output.

- Do not connect the camera to other HDMI output devices. Doing so may damage the camera.
- HDMI output is not performed while connected via USB to a computer.
- When [4K] is selected, video output in shooting mode is [1080p].
- Turn the camera off before disconnecting the HDMI cable.



### Using the TV remote control

The camera can be operated by a TV remote control when connected to a TV that supports HDMI control. Select [On] for [HDMI Control]. When [On] is selected, camera controls can be used for playback only.

- You can operate the camera by following the operation guide displayed on the TV.
- During single-frame playback, you can display or hide the information display by pressing the “Red” button, and display or hide the index display by pressing the “Green” button.
- Some televisions may not support all features.

### Shutter speeds when the flash fires (⚡ X-Sync./⚡ Slow Limit)

MENU → ⚙ → [E] → [⚡ X-Sync.]/[⚡ Slow Limit]

You can set shutter speed conditions for when the flash fires.

Shooting mode	Flash firing shutter speed	Upper limit	Lower limit
<b>P</b>	The camera automatically sets the shutter speed.	[⚡ X-Sync.] setting <sup>*1</sup>	[⚡ Slow Limit] setting <sup>*2</sup>
<b>A</b>			
<b>S</b>	The set shutter speed		No lower limit
<b>M</b>			

\*1 1/200 seconds when using a separately sold external flash.

\*2 Extends up to 60 seconds when slow synchronization is set.

### Combinations of JPEG image sizes and compression rates

(⏪ Set)

MENU → ⚙ → [E] → [⏪ Set]

You can set the JPEG image quality by combining image size and compression rate.

Image size		Compression rate		
Name	Pixel Count	SF (Super Fine)	F (Fine)	N (Normal)
<b>L</b> (Large)	5184×3888	<b>L</b> SF	<b>L</b> F	<b>L</b> N
<b>M</b> (Middle)	3200×2400	<b>M</b> SF	<b>M</b> F	<b>M</b> N
<b>S</b> (Small)	1280×960	<b>S</b> SF	<b>S</b> F	<b>S</b> N

Use the camera's wireless LAN (Wi-Fi) and **Bluetooth®** features to connect to a smartphone, where you can use the dedicated app to enhancement your enjoyment of the camera both before and after shooting. Once a connection has been established, you can download and take pictures remotely and add GPS tags to the images on the camera.

- Operation is not guaranteed on all smartphones.

## Things you can do with the specified app, OLYMPUS Image Share (OI.Share)

- Download images from the camera to the smartphone  
You can load images in the camera to a smartphone.  
You can also use the smartphone to select images for download from the camera.
- Remote shooting from a smartphone  
You can remotely operate the camera and shoot using a smartphone.
- Access information to help you enjoy your camera and photography.  
You can easily access explanations of photographic techniques (Photo Guide), the Instruction Manual, and the photo-sharing community site even when on the go.

For details, visit the address below:

<https://app.olympus-imaging.com/oishare/>

## Things you can do with the specified app, Olympus Image Palette (OI.Palette)

- Beautiful image processing  
Use intuitive controls to apply impressive effects to images downloaded to your smartphone.

For details, visit the address below:

<https://app.olympus-imaging.com/oipalette/>

## Things you can do with the specified app, OLYMPUS Image Track (OI.Track)

- Addition of GPS tags to camera images  
You can add GPS tags to images simply by transferring the GPS log saved on the smartphone to the camera.



For details, visit the address below:

<https://app.olympus-imaging.com/oitrack/>



- Before using the wireless LAN function, read "Using the wireless LAN/**Bluetooth®** functions" (P. 179).
- Olympus accepts no responsibility for violations of local regulations governing wireless communications caused by the use of the camera's wireless LAN/**Bluetooth®** features outside the country or region of purchase.
- As with any wireless communication, there is always a risk of interception by a third party.
- The wireless LAN function on the camera cannot be used to connect to a home or public access point.
- The transceiver antenna is located inside the grip. Keep the antenna away from metal objects whenever possible.
- Depending on the composition of the container or the objects it contains, the camera may be unable to connect to a smartphone when placed inside a bag or other container.
- During wireless LAN connection, the battery will run down faster. If the battery is running low, the connection may be lost during a transfer.
- Connection may be difficult or slow in proximity to devices that generate magnetic fields, static electricity or radio waves, such as near microwaves, cordless telephone.
- Wireless LAN can not be used when the memory card write-protect switch is in the "LOCK" position.

## Pairing the Camera and Smartphone

Follow the steps below when connecting the devices for the first time.

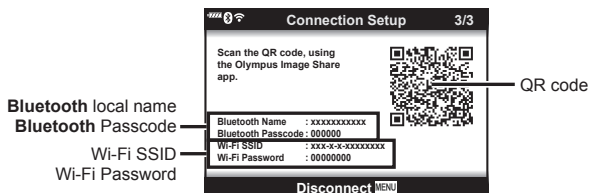
- Adjust pairing settings using OI.Share, not the settings app that is part of the smartphone operating system.
- 1 Launch the copy of the dedicated OI.Share app previously installed on your smartphone.
  - 2 Select [Device Connection] in the  Playback Menu and press .
    - You can also connect by tapping  in the monitor.
  - 3 Follow the on-screen guide to adjust Wi-Fi/Bluetooth settings.
    - The **Bluetooth** local name and passcode, the Wi-Fi SSID and password, and a QR code are displayed in the monitor.



- 4 Tap the camera icon at the bottom of the OI.Share display.
  - An [Easy Setup] tab will be displayed.
- 5 Follow the on-screen instructions in OI.Share to scan the QR code and adjust connection settings.
  - If you are unable to scan the QR code, follow the on-screen instructions in OI.Share to adjust settings manually.
    - **Bluetooth**: To connect, select the local name and enter the passcode displayed in the camera monitor into the **Bluetooth** settings dialog in OI.Share.
    - Wi-Fi: To connect, enter the SSID and password displayed on the camera monitor into the Wi-Fi settings dialog in OI.Share.
  -  1 will be displayed when pairing is complete.
  - The **Bluetooth**® icon indicates the status as follows:
    - : The camera is emitting wireless signal.
    - : Wireless connection has been established.
- 6 To end the Wi-Fi connection, press **MENU** on the camera or tap [Disconnect] on the monitor screen.
  - You can also turn the camera off and end the connection from OI.Share.
  - At default settings, **Bluetooth**® connection is kept active even after Wi-Fi connection is terminated, allowing you to shoot remotely with a smartphone. To set the camera to also terminate **Bluetooth**® connection when terminating Wi-Fi connection, set [Bluetooth] to [Off].

## Wireless Connection Standby Setting for When the Camera Is On

You can choose whether the camera will be on standby for wireless connection with the smartphone when the power is on.

- 1 Highlight [Wi-Fi/Bluetooth Settings] in the  $\uparrow$  setup menu and press  $\triangleright$ .
- 2 Highlight [Bluetooth] and press  $\triangleright$ .
  - Complete the pairing of camera and smartphone beforehand. [Bluetooth] cannot be selected unless the pairing has been completed.
- 3 Highlight the desired option and press the  $\text{OK}$  button.

Off	The camera will not be on standby for wireless connection and wireless signal will not be emitted even when the power is on. For connection with a smartphone, start [Device Connection] in the $\text{▶}$ playback menu of the camera.
On	When the camera is on, it will emit wireless signal and be on standby for wireless connection. You can connect the camera and the smartphone through operation of OI.Share and shoot remotely or transfer images.

- Because the [Bluetooth] setting also serves as an indicator of **Bluetooth**<sup>®</sup> connection status of the camera, [Stopped] and [Running] may be displayed besides the setting options [Off] and [On].

## Wireless Settings for When the Camera Is Off

You can choose whether the camera will maintain a wireless connection to the smartphone when off.

- 1 Highlight [Wi-Fi/Bluetooth Settings] in the  $\Psi$  setup menu and press  $\triangleright$ .
- 2 Highlight [Power-off Standby] and press  $\triangleright$ .
- 3 Highlight the desired option and press the  $\odot$  button.

<b>Select</b>	When you turn the camera off, you will be prompted to choose whether to maintain the wireless connection to the smartphone.
<b>Off</b>	Turning the camera off terminates the wireless connection to the smartphone.
<b>On</b>	When the camera is turned off, the connection to the smartphone remains active and the smartphone can still be used to download or view the pictures on the camera.

### ■ “Select”

When [Select] is chosen for [Power-off Standby], a confirmation dialog will be displayed before the camera turns off if all the following conditions are met:

- [On] is selected for [Wireless Functions]
- The camera is currently connected with a smartphone (P. 143)
- The memory card is correctly inserted

<b>Yes</b>	Turn the camera off but leave the wireless smartphone connection active.
<b>No</b>	Turn the camera off and terminate the wireless smartphone connection.

- If no operations are performed about a minute after the confirmation dialog is displayed, the camera will end the wireless connection to the smartphone and turn off automatically.
- The first time you turn the camera off after connecting to a smartphone (P. 143), you may be prompted to choose whether to hide the confirmation dialog in future. To keep the camera from displaying the confirmation dialog when turned off in future, select [Don't show this screen again].

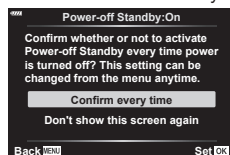
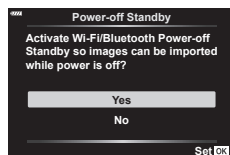



- If left active, the wireless connection will automatically terminate if:
  - the connection remains inactive for 12 hours
  - the memory card is removed
  - the battery is replaced
  - a charging error occurs during on-board battery charging

The connection can be restored by turning the camera on.



- Note that if [On] is selected for [Power-off Standby], camera may not turn on immediately when the **ON/OFF** lever is rotated to **ON**.

## 5

### Connecting the camera to a smartphone

## Transferring images to a smartphone

You can select images in the camera and load them to a smartphone. You can also use the camera to select images you want to share in advance.  “Selecting Pictures for Sharing (Share Order)” (P. 111)

- 1 Start [Device Connection] on the camera (P. 143).
  - You can also connect by tapping  in the monitor.
  - If you have previously connected to the smartphone, the camera will start the connection automatically.
  -  1 will be displayed when pairing is complete.

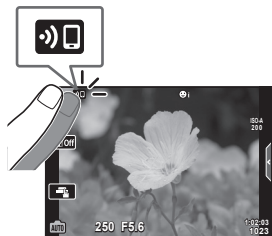

- 2 Tap [Import Photos] in OI.Share on the smartphone.
  - The images in the camera are displayed in a list.
- 3 Select the pictures you want to transfer and tap the Save button.
  - When saving is completed, you can turn off the camera from the smartphone.



- If the following options are selected for [Wi-Fi/Bluetooth settings] in the camera  (setup) menu, you can download pictures to the smartphone as described in Steps 3 and 4, above, even when the camera is off:
  - [Wireless Functions]: [On]
  - [Power-off standby]: [On]

## Automatically uploading images while the camera is off

To configure the camera to automatically upload images to a smartphone while off:

- Mark images for sharing (P. 111)
- Enable power-off standby (P. 145)
- If you are using an iOS device, launch OI.Share



- Auto upload is not available if you are connected via a router (for example, a home network), in which case you will need to transfer pictures using OI.Share.
- Some smartphones may terminate upload on entering sleep mode. Keep the smartphone awake while upload is in progress.

## Shooting remotely with a smartphone (Live View)

You can shoot remotely by operating the camera with a smartphone while checking the live view on the smartphone screen.

- The camera shows the connection screen and all operations are performed from the smartphone.
- 1** Start [Device Connection] on the camera.
    - You can also connect by tapping  in the monitor.
  - 2** Launch OI.Share and tap [Remote Control].
  - 3** Tap [Live View].
  - 4** Tap the shutter button to shoot.
    - The image taken is saved on the memory card in the camera.
- Available shooting options are partially limited.

## Shooting remotely with a smartphone (Remote Shutter)



You can shoot remotely by operating the camera with a smartphone (Remote Shutter).

- All operations are available on the camera. In addition, you can shoot pictures and record movies using the shutter button displayed on the smartphone screen.
  - If [Bluetooth] (P. 144) is set to [Off], set it to [On].
  - If [Bluetooth] is set to [On], the camera will be on standby for wireless connection as soon as it is turned on.
- 1** Launch OI.Share and tap [Remote Control].
  - 2** Tap [Remote Shutter].
  - 3** Tap the shutter button to shoot.
    - The image taken is saved on the memory card in the camera.
- The camera does not enter sleep mode while connected with a smartphone.
  - Even if [Bluetooth] is set to [Off], [Remote Shutter] can be used by starting [Device Connection] on the camera.







## Adding position information to images

You can add GPS tags to images that were taken while the GPS log was saving by transferring the GPS log saved on the smartphone to the camera.

- 1 Before taking pictures with the camera, launch OI.Track on the smartphone to begin saving the GPS log.
    - Before starting a GPS track log, you will need to connect once via OI.Track and synchronize the clock.
    - You can use the phone or other apps while the GPS log is saving. Do not terminate OI.Track.
  - 2 Once you have finished taking pictures with the camera, end tracking in OI.Share.
  - 3 Tap the  icon in the camera monitor to connect to the smartphone.
    - You can also connect by selecting [Device Connection] in the  playback menu.
  - 4 Upload the GPS log to the camera using OI.Track.
    - The GPS log will be used to add location data to any pictures taken after you launched OI.Track in Step 1.
    -  is displayed on images to which position information has been added.
- Addition of location information can only be used with smartphones that have a GPS function.
  - Position information cannot be added to movies.





## Resetting wireless LAN/Bluetooth® settings

To restore [Wi-Fi/Bluetooth Settings] to default values:

- 1 Select [Wi-Fi/Bluetooth Settings] in the  Setup Menu and press .
- 2 Select [Reset Settings] and press .
- 3 Select [Yes] and press the  button.
  - The following settings will be reset:  
[Wireless Functions] (P. 150)/[Bluetooth] (P. 144)/[Connection Password]/[Power-off Standby] (P. 145)
  - When you reset the settings, pairing with the smartphone will also be reset. To connect the camera to a smartphone, start [Device Connection] again.





## Changing the password

To change the Wi-Fi/**Bluetooth** passwords:



- 1 Select [Wi-Fi/Bluetooth Settings] in the  Setup Menu and press .
- 2 Select [Connection Password] and press .
- 3 Follow the operation guide and press the  button.
  - A new password will be set.
  - Both the Wi-Fi connection password and **Bluetooth**<sup>®</sup> connection passcode can be changed.
  - Reconnect to the smartphone after changing passwords.  "Pairing the Camera and Smartphone" (P. 143)

## Disabling wireless LAN/Bluetooth<sup>®</sup>

To disable wireless LAN/**Bluetooth**<sup>®</sup>:

- 1 Select [Wi-Fi/Bluetooth Settings] in the  Setup Menu and press .
- 2 Select [Wireless Functions] and press .
- 3 Select [Off] and press the  button.
  - The following functions will be disabled.  
[Device Connection] (P. 143)/[Power-off Standby] (P. 145)/[Bluetooth] (P. 144)



- To disable wireless LAN/**Bluetooth**<sup>®</sup> only while the camera is off, select [Off] for [Wi-Fi/Bluetooth Settings] > [Power-off Standby].  "Wireless Settings for When the Camera Is Off" (P. 145)
- To disable wireless connection standby only while the camera is on and stop the emission of wireless signal, select [Off] for [Wi-Fi/Bluetooth Settings] > [Bluetooth].  "Wireless Connection Standby Setting for When the Camera Is On" (P. 144)

# 6 Connecting the camera to a computer

## Copying pictures to a computer

- 1 Turn the camera off and connect it to the computer.

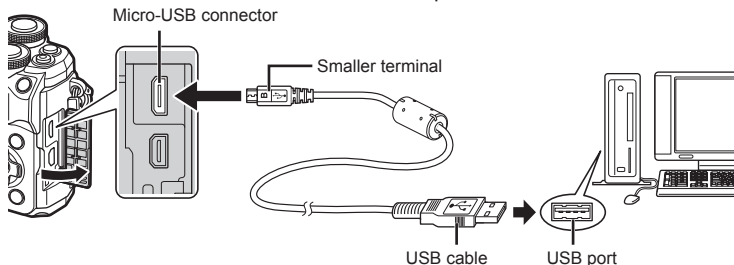

- The location of the USB port varies with the computer. For details, refer to your computer's manual.

- 2 Turn the camera on.

- The selection screen for the USB connection is displayed.
- When the camera is connected to a computer via USB, a dialog should be displayed in the monitor prompting you to choose a host. If it is not, select [Auto] for [USB Mode] (P. 133) in the camera custom menus.
- If nothing is displayed on the camera screen even after connecting the camera to the computer, the battery may be exhausted. Use a full-charged battery.

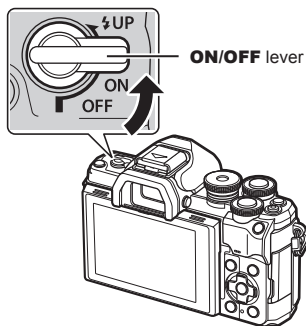

- 3 Press  $\Delta$ / $\nabla$  to select [Storage]. Press the  $\odot$  button.

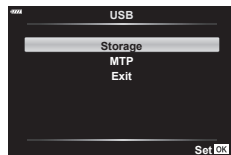

#### 4 The computer recognizes the camera as a new device.

- Data transfer is not guaranteed in the following environments, even if your computer is equipped with a USB port.
  - Computers with a USB port added by means of an extension card, etc., computers without a factory-installed OS, or home-built computers
- Camera controls cannot be used while the camera is connected to a computer.

### Installing the PC software

Install the following software to access the camera while it is connected directly to the computer via USB.

#### Olympus Workspace

This computer application is used to download and view photos and movies recorded with the camera. It can also be used to update the camera firmware. The software can be downloaded from the website below. Be prepared to provide the camera serial number when downloading the software.

<https://support.olympus-imaging.com/owdownload/>

## Batteries

- The camera uses a single Olympus lithium-ion battery. Never use any battery other than genuine OLYMPUS batteries.
- The camera's power consumption varies widely with usage and other conditions.
- As the following consume a lot of power even without shooting, the battery will be drained quickly.
  - Performing auto focus repeatedly by pressing the shutter button halfway in shooting mode.
  - Displaying images on the monitor for a prolonged period.
  - When connected to a computer.
  - Leaving wireless LAN/**Bluetooth**® enabled.
- When using a drained battery, the camera may turn off without the low battery warning being displayed.
- Remove the batteries before putting the camera into storage for periods of a month or more.

Leaving the batteries in the camera for extended periods shortens their lives, potentially rendering them unusable.
- The battery will not be fully charged at the time of purchase. Charge the battery using the supplied USB-AC adapter before use.
- The normal charging time using the provided USB-AC adapter is approximately 4 hours (estimated).
- Do not use USB-AC adapters or chargers not specifically designated for use with batteries of the supplied type. Similarly, do not use the supplied USB-AC adapter with batteries (cameras) other than those of the designated type.
- There is a risk of explosion if the battery is replaced with the incorrect battery type.
- Dispose of the used battery following the instructions "CAUTION" (P. 178) in the instruction manual.

## Using your USB-AC adapter abroad

- The USB-AC adapter can be used in most home electrical sources within the range of 100V to 240V AC (50/60Hz) around the world. However, depending on the country or area you are in, the AC wall outlet may be shaped differently and the USB-AC adapter may require a plug adapter to match the wall outlet.
- Do not use commercially available travel adapters as the USB-AC adapter may malfunction.

## Usable cards

In this manual, all storage devices are referred to as “cards.” The following types of SD memory card (commercially available) can be used with this camera: SD, SDHC, and SDXC. For the latest information, please visit the Olympus website.



### SD card write protect switch

The SD card body has a write protect switch. Setting the switch to “LOCK” prevents data being written to the card. Return the switch to the unlock position enable writing.



- Cards must be formatted with this camera before first use or after being used with other cameras or computers. “Formatting the card (Card Setup)” (P. 131)
- The data in the card will not be erased completely even after formatting the card or deleting the data. When discarding, destroy the card to prevent leakage of personal information.
- Access to some playback functions and the like may be restricted when the write-protect switch is in the “LOCK” position.

## Record mode and file size/number of storable still pictures

The file size in the table is approximate for files with a 4:3 aspect ratio.

Record mode	Image size (Pixel Count)	Compression	File format	File size (MB)	Number of storable still pictures*
RAW	5184×3888	Loss-less compression	ORF	17.4	867
SF		1/2.7	JPEG	13.1	1054
F		1/4		8.9	1549
N		1/8		4.6	3013
SF	3200×2400	1/2.7		5.1	2696
F		1/4		3.6	3905
N		1/8		1.9	7395
SF	1280×960	1/2.7		1.0	13559
F		1/4		0.8	18079
N		1/8		0.5	28713

\* Assumes a 16GB SD card.

- The number of storable still pictures may change according to the subject, whether or not print reservations have been made, and other factors. In certain instances, the number of storable still pictures displayed on the monitor will not change even when you take pictures or erase stored images.
- The actual file size varies according to the subject.
- The maximum number of storable still pictures displayed on the monitor is 9999.
- For the available recording time for movies, see the Olympus website.

## Interchangeable lenses

Choose a lens according to the scene and your creative intent. Use lenses designed exclusively for the Micro Four Thirds system and bearing the M.ZUIKO DIGITAL label or the symbol shown at right. With an adapter, you can also use Four Thirds System and OM System lenses. The optional adapter is required.



- When you attach or remove the body cap and lens from the camera, keep the lens mount on the camera pointed downward. This helps prevent dust and other foreign matter from getting inside the camera.
- Do not remove the body cap or attach the lens in dusty places.
- Do not point the lens attached to the camera toward the sun. This may cause the camera to malfunction or even ignite due to the magnifying effect of sunlight focusing through the lens.
- Be careful not to lose the body cap and rear cap.
- Attach the body cap to the camera to prevent dust from getting inside when no lens is attached.

### ■ Lens and camera combinations

Lens	Camera	Attachment	AF	Metering
Micro Four Thirds system lens	Micro Four Thirds system camera	Yes	Yes	Yes
Four Thirds system lens		Attachment possible with mount adapter	No*1	Yes
OM System lenses			No	Yes*2

\*1 Only MF (manual focus) is available.

\*2 Accurate metering is not possible.

## MF Clutch Lenses

The “MF clutch” (manual focus clutch) mechanism on MF clutch lenses can be used to switch between auto and manual focus simply by repositioning the focus ring.

- Check the position of the MF clutch before shooting.
- Sliding the focus ring to the AF/MF position at the end of the lens selects autofocus, while sliding it to the MF position closer to the camera body selects manual focus, regardless of the focus mode chosen with the camera.

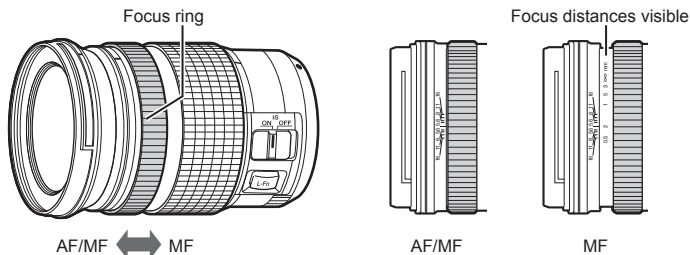

- Selecting [MF] for focus mode on the camera disables autofocus even when the focus ring is in the AF/MF position.

7

Cautions



## Compatible Flash Units

Choose a flash unit to suit your needs, taking into consideration such factors as the output required and whether the unit supports macro photography. Flash units designed to communicate with the camera support a variety of flash modes, including TTL auto and super FP. Flash units can be mounted on the camera hot shoe or connected using a cable (available separately) and flash bracket. See the documentation provided with the flash unit for information on flash features and their use. The camera also supports the following wireless flash control systems:

### **Radio-Controlled Flash Photography: CMD, ⚡CMD, RCV, and X-RCV Modes**

The camera controls one or more remote flash units by means of radio signals. The range of locations in which flash units can be placed increases. Flash units can control other compatible units or be fitted with radio commander/receivers to allow the use of units that do not otherwise support radio flash control.

### **Wireless Remote-Control Flash Photography: RC Mode**

The camera controls one or more remote flash units by means of optical signals. The flash mode can be selected using camera controls (P. 75).

### **■ Features Available with Compatible Flash Units**



Flash unit	Supported flash control modes	GN (Guide Number, ISO 100)	Supported wireless systems
<b>FL-700WR</b>	TTL-AUTO, MANUAL, FP TTL AUTO, FP MANUAL, MULTI, RC, SL MANUAL	GN 42 (75/150 mm <sup>*1</sup> ) GN 21 (12/24 mm <sup>*1</sup> )	CMD, ⚡CMD, RCV, X-RCV, RC
<b>FL-900R</b>	TTL-AUTO, AUTO, MANUAL, FP TTL AUTO, FP MANUAL, MULTI, RC, SL AUTO, SL MANUAL	GN 58 (100/200 mm <sup>*1</sup> ) GN 27 (12/24 mm <sup>*1</sup> )	RC
<b>STF-8</b>	TTL-AUTO, MANUAL, RC <sup>*2</sup>	GN 8.5	RC <sup>*2</sup>

\*1 Maximum lens focal length at which unit can provide flash coverage (figures following slashes are 35 mm format equivalent focal lengths).

\*2 Functions as commander (transmitter) only.

## Wireless remote control flash photography

External flash units that are designated for use with this camera and have a remote control mode can be used for wireless flash photography. The camera can separately control each of three groups of remote flash units, and the internal flash. See the instruction manuals provided with the external flash units for details.

- 1 Set the remote flash units to RC mode and place them as desired.
  - Turn the external flash units on, press the MODE button, and select RC mode.
  - Select a channel and group for each external flash unit.
- 2 Select [On] for [⚡ RC Mode] in  Shooting Menu 2 (P. 118).
  - Press the  button to exit to the RC mode display. Press the **INFO** button to cycle between LV super controls or live controls and the RC mode display.
  - Select a flash mode (note that red-eye reduction is not available in RC mode).
- 3 Adjust the settings for each group in the RC mode display.

### Group

- Select the flash control mode and adjust the flash intensity separately for each group. For MANUAL, select the flash intensity.

Adjust settings for the camera flash unit.

### Flash intensity value

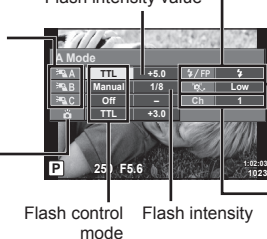

Normal flash/Super FP flash  
• Switch between normal flash and Super FP flash.

Communication light level  
• Set the communication light level to [HI], [MID], or [LO].

Channel  
• Set the communication channel to the same channel used on the flash.

- 4 Rotate the **ON/OFF** lever to **⚡UP** to raise the flash.
  - After confirming that the flash has charged, take a test shot.

### ■ Wireless flash control range

Position the wireless flash units with their remote sensors facing the camera. The following illustration shows the approximate ranges at which the flash units can be positioned. The actual control range varies with local conditions.

- We recommend using a single group of up to three remote flash units.
- Remote flash units cannot be used for second curtain slow synchronization exposures longer than 4 seconds.
- If the subject is too close to the camera, the control flashes emitted by the camera flash may affect exposure (this effect can be reduced by reducing the output of the camera flash by, for example, using a diffuser).
- The upper limit of flash synchronization timing is 1/160 sec. when using the flash in RC mode.

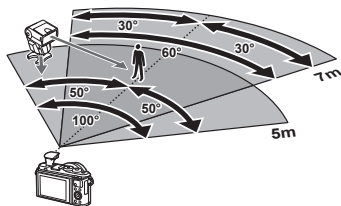

## Other external flash units

Note the following when using a third-party flash unit mounted on the camera hot shoe:

- Using obsolete flash units that apply currents of more than about 24 V to the X-contact will damage the camera.
- Connecting flash units with signal contacts that do not conform to Olympus specifications may damage the camera.
- Set the Shooting mode to **M**, set the shutter speed to a value no higher than flash synchronous speed, and set ISO sensitivity to a setting other than [AUTO].
- Flash control can only be performed by manually setting the flash to the ISO sensitivity and aperture values selected with the camera. Flash brightness can be adjusted by adjusting either ISO sensitivity or aperture.
- Use a flash with an angle of illumination suited to the lens. Angle of illumination is usually expressed using 35-mm format equivalent focal lengths.

## Principal Accessories

### ■ Converter lenses

Converter lenses attach to the camera lens for quick and easy fish-eye or macro photography. See the OLYMPUS website for information on the lenses that can be used.

### ■ Eyecup (EP-16)

You can switch to a large-size eyecup.

#### Removal

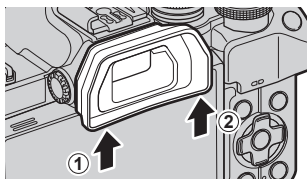

## System chart

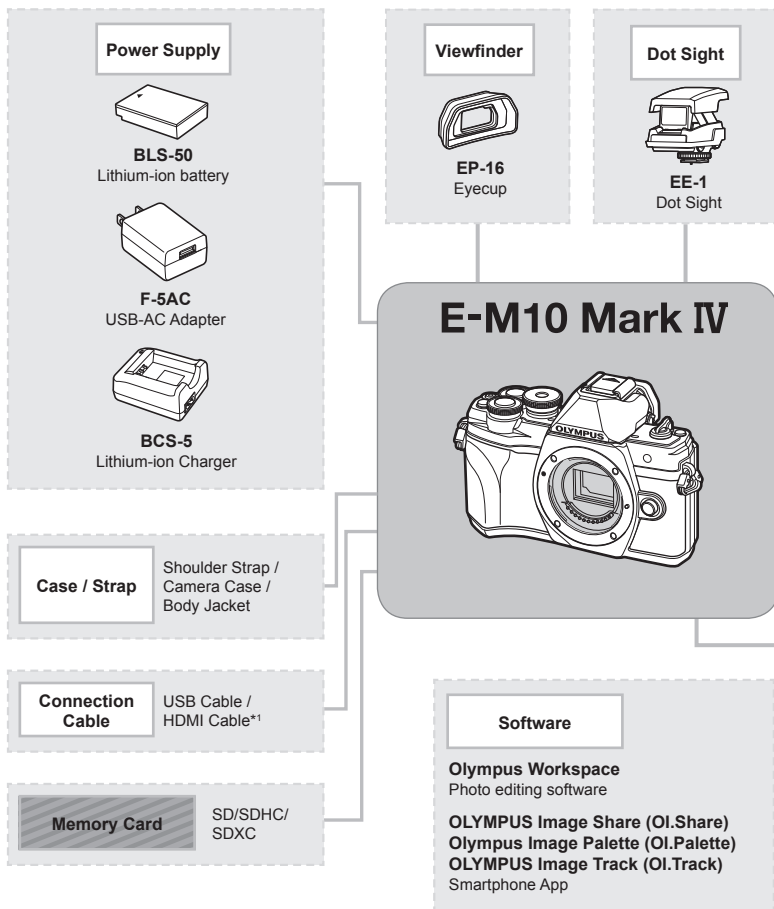

 : E-M10 Mark IV compatible products

 : Commercially available products

For the latest information, please visit the Olympus website.

\*1 HDMI cables are available from third-party suppliers.

\*2 Not all lenses can be used with adapter. For details, refer to the Olympus Official Web Site.

\*3 For compatible lens, refer to the Olympus Official Web Site.

## Lens



Micro Four Thirds system lenses



**MMF-2/MMF-3<sup>2</sup>**  
Four Thirds Adapter

**Four Thirds System Lenses**



**BCL-1580/BCL-0980**  
Body Cap Lens

## Converter Lens\*3

**FCON-P01**  
Fisheye

**WCON-P01**  
Wide

**MCON-P01**  
Macro

**MCON-P02**  
Macro

**MC-14**  
Teleconverter

**MC-20**  
Teleconverter

## Flash



**FL-900R**  
Electronic Flash

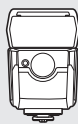

**FL-700WR**  
Electronic Flash

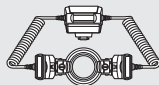

**STF-8**  
Macro Flash

## Radiowave System Accessories



**FC-WR**  
Wireless radiowave  
commander



**FR-WR**  
Wireless radiowave receiver

## Cleaning and storing the camera

### Cleaning the camera

Turn off the camera and remove the battery before cleaning the camera.

- Do not use strong solvents such as benzene or alcohol, or a chemically treated cloth.

#### Exterior:

- Wipe gently with a soft cloth. If the camera is very dirty, soak the cloth in mild soapy water and wring well. Wipe the camera with the damp cloth and then dry it with a dry cloth. If you have used the camera at the beach, use a cloth soaked in clean water and well wrung.

#### Monitor:

- Wipe gently with a soft cloth.

#### Lens:

- Blow dust off the lens with a commercially available blower. For the lens, wipe gently with a lens cleaning paper.

### Storage

- When not using the camera for a prolonged period, remove the battery and card. Store the camera in a cool, dry place that is well ventilated.
- Insert the battery periodically and test the camera's functions.
- Remove dust and other foreign matter from the body and rear caps before attaching them.
- Attach the body cap to the camera to prevent dust from getting inside when no lens is attached. Be sure to replace the front and rear lens caps before putting the lens away.
- Clean the camera after use.
- Do not store with insect repellent.
- Avoid storing the camera in places where chemicals are treated, in order to protect the camera from corrosion.
- Mold may form on the lens surface if the lens is left dirty.
- Check each part of the camera before use if it has not been used for a long time. Before taking important pictures, be sure to take a test shot and check that the camera works properly.

### Cleaning and checking the image pickup device

This camera incorporates a dust reduction function to keep dust from getting on the image pickup device and to remove any dust or dirt from the image pickup device surface with ultrasonic vibrations. The dust reduction function operates when the camera is turned on.

The dust reduction function operates at the same time as the pixel mapping, which checks the image pickup device and image processing circuitry. Since dust reduction is activated every time the camera's power is turned on, the camera should be held upright for the dust reduction function to be effective.

## Pixel Mapping - Checking the image processing functions

The pixel mapping feature allows the camera to check and adjust the image pickup device and image processing functions. Before using the pixel mapping function to ensure that it operates correctly, wait for 1 minute or longer immediately after shooting or playback.

- 1 In Custom Menu **1**, select [Pixel Mapping] (P. 137).
- 2 Press **▶**, then press the **OK** button.
  - The [Busy] bar is displayed when pixel mapping is in progress. When pixel mapping is finished, the menu is restored.
  - If you accidentally turn the camera off during pixel mapping, start again from Step 1.

## Shooting tips and information

### The camera does not turn on even when a battery is loaded

#### The battery is not fully charged

- Charge the battery with the USB-AC adapter.

#### The battery is temporarily unable to function because of the cold

- Battery performance drops at low temperatures. Remove the battery and warm it by putting it in your pocket for a while.

### A language-selection prompt is displayed

The dialog shown in the illustration will be displayed in the following circumstances:

- The camera is turned on for the first time
- You previously ended initial setup without choosing a language

Choose a language as described in "Initial setup" (P. 22).

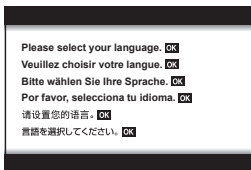

### The date and time has not been set

#### The camera is used with the settings at the time of purchase

- The date and time of the camera is not set when purchased. Set the date and time before using the camera. "Initial setup" (P. 22)

#### The battery has been removed from the camera

- The date and time settings will be returned to the factory default settings if the camera is left without the battery for approximately 1 day. The settings will be canceled more quickly if the battery was only loaded in the camera for a short time before being removed. Before taking important pictures, check that the date and time settings are correct.

### Set functions are restored to their factory default settings

Options selected in **AUTO** () , **SCN**, or **VAP** mode are reset when the mode dial is rotated to another setting.

### Functions that cannot be selected from menus

Some items may not be selectable from the menus when using the arrow pad.

- Items that cannot be set with the current shooting mode.
- Items that cannot be set because of an item that has already been set.  
Combinations of [] (P. 77) and [Noise Reduct.] (P. 134), etc.

### The number of AF targets is reduced

The size and number of the AF targets changes with the aspect ratio (P. 86), the AF target mode (P. 72), and the option selected for [Digital Tele-converter] (P. 119).



## No picture is taken when the shutter button is pressed

### The camera has turned off automatically

- The camera automatically enters sleep mode to reduce the drain on the battery if no operations are performed for a set period of time.  [Sleep] (P. 137)  
Press the shutter button halfway to exit the sleep mode.  
The camera will turn off automatically if no operations are performed for an additional 4 hours.

### The flash is charging

- On the monitor, the  mark blinks when charging is in progress. Wait for the blinking to stop, then press the shutter button.

### Unable to focus

- The camera cannot focus on subjects that are too close to the camera or that are not suited to autofocus (the AF confirmation mark will blink in the monitor). Increase the distance to the subject or focus on a high contrast object at the same distance from the camera as your main subject, compose the shot, and shoot.

#### Subjects that are difficult to focus on

It may be difficult to focus with auto focus in the following situations.

AF confirmation mark is blinking.  
These subjects are not focused.

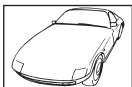

Subject with low contrast

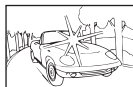

Excessively bright light in center of frame

AF confirmation mark lights up but the subject is not focused.



Subjects at different distances

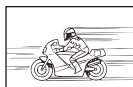

Fast-moving subject



Subject not inside AF area

### Noise reduction is activated

- When shooting night scenes, shutter speeds are slower and noise tends to appear in images. The camera activates the noise-reduction process after shooting at slow shutter speeds. During which, shooting is not allowed. You can set [Noise Reduct.] to [Off].  
 [Noise Reduct.] (P. 134)

### Image taken appears whitish

This may occur when the picture is taken in backlight or semi-backlight conditions. This is due to a phenomenon called flare or ghosting. As far as possible, consider a composition where strong light source is not taken in the picture. Flare may occur even when a light source is not present in the picture. Use a lens hood to shade the lens from the light source. If a lens hood does not have effect, use your hand to shade the lens from the light.  
 "Interchangeable lenses" (P. 155)

### Unknown bright dot(s) appear on the subject in the picture taken

This may be due to stuck pixel(s) on the image pickup device. Perform [Pixel Mapping]. If the problem persists, repeat pixel mapping a few times.  "Pixel Mapping - Checking the image processing functions" (P. 163)

## The subject appears distorted

The following functions use an electronic shutter:

movie recording (P. 65)/silent (P. 78)/the **SCN** mode panorama (P. 38), "silent" (P. 38), and "multi-focus shot" (P. 39) options/the **JAP** mode "silent" (P. 45), panorama (P. 46), and "focus bracketing" (P. 49) options

This may cause distortion if the subject is moving rapidly or the camera is moved abruptly. Avoid moving the camera abruptly during shooting or use standard sequential shooting.

## Lines appear in photographs



The following functions use an electronic shutter, which may result in lines due to flicker and other phenomena associated with fluorescent and LED lighting, an effect that can sometimes be reduced by choosing slower shutter speeds:

movie recording (P. 65)/silent (P. 78)/the **SCN** mode panorama (P. 38), "silent" (P. 38), and "multi-focus shot" (P. 39) options/the **JAP** mode "silent" (P. 45), panorama (P. 46), and "focus bracketing" (P. 49) options

## The camera is stuck in manual focus (MF) mode

Some lenses are equipped with a manual focus clutch that engages manual focus when the focus ring is slid back. Check the lens.  [MF Clutch Lenses] (P. 156)

## Changing the number of frames or adding frames to the index playback display

Use the /Info Settings >  Settings] option in custom menu **C1** to change the number of frames shown in or add frames to the index playback display (P. 139).

## Hiding menu guides

Press the **INFO** button to hide or show on-screen guides in the menu display (P. 117).











## Viewing the functions assigned to dials and buttons



Use the options in Custom Menu **B** to view the functions assigned to camera controls. [Button Function] (P. 132)/ Function] (P. 132)/[Dial Function] (P. 132)

## Movies do not play back smoothly when viewed on a TV

The movie frame rate may not match the video standard used in the TV. View the movie on a computer instead. Before recording movies for display on a TV, choose a frame rate that matches the video standard used in the device.  [Video Frame Rate] (P. 125)

## Error codes

Monitor indication	Possible cause	Corrective action
 No Card	The card is not inserted, or it cannot be recognized.	Insert a card or insert a different card.
 Card Error	There is a problem with the card.	Insert the card again. If the problem persists, format the card. If the card cannot be formatted, it cannot be used.
 Write Protect	Writing to the card is prohibited.	The card write-protect switch is set to the "LOCK" side. Release the switch. (P. 154)
 Card Full	<ul style="list-style-type: none"> <li>The card is full. No more pictures can be taken or no more information such as print reservation can be recorded.</li> <li>There is no space in the card and print reservation or new images cannot be recorded.</li> </ul>	Replace the card or erase unwanted pictures. Before erasing, download important images to a PC.
 No Picture	There are no pictures on the card.	The card contains no pictures. Record pictures and play back.
 Picture Error	The selected picture cannot be displayed for playback due to a problem with this picture. Or the picture cannot be used for playback on this camera.	Use image processing software to view the picture on a PC. If that cannot be done, the image file is damaged.
 The Image Cannot Be Edited	Pictures taken with another camera cannot be edited on this camera.	Use image processing software to edit the picture.
Y/M/D	The clock is not set.	Set the clock (P. 23).
 °C/°F		Turn off the camera and wait for the internal temperature to cool.
 Internal camera temperature is too high. Please wait for cooling before camera use.	The internal temperature of the camera has risen due to sequential shooting.	Wait a moment for the camera to turn off automatically. Allow the internal temperature of the camera to cool before resuming operations.
 Battery Empty	The battery is drained.	Charge the battery.

Monitor indication	Possible cause	Corrective action
 No Connection	The camera is not correctly connected to a computer, HDMI display, or other device.	Reconnect the camera.
 Cannot Print	It may not be possible to create print reservations for pictures recorded on other cameras via this camera.	Print separately via a personal computer, etc.
The lens is locked. Please extend the lens.	The lens of the retractable lens stays retracted.	Extend the lens.
Please check the status of a lens.	An abnormality has occurred between the camera and the lens.	Turn off the camera, check the connection with the lens, and turn the power on again.
This function requires a compatible lens. Please attach a compatible lens.	The lens does not support the selected shooting mode.	Choose a lens that does or choose a different shooting mode.

## Defaults

\*1: Default can be restored by selecting [Full] for [Reset].

\*2: Default can be restored by selecting [Basic] for [Reset].

## Button Functions/Live Control/LV Super Control

Function	Default	*1	*2	
ISO	AUTO	✓	✓	74
Sequential shooting/Self-timer		✓	✓	77
AF target settings		✓	✓	72
Flash photography		✓	✓	75
AF mode	S-AF	✓	✓	84
AF mode	C-AF	✓	✓	125
Aspect ratio	4:3	✓	✓	86
	<b>L</b> F	✓	✓	86
(4K)	3840×2160 30p	—	—	89
(Standard)	1920×1080 Fine 60p	✓	✓	90
(High-speed)	1280×720 HighSpeed 120fps	—	—	89
Movie (exposure) mode	<b>P</b>	✓	—	91

## Shooting Menu

Tab	Function	Default	*1	*2		
	Reset	Basic	—	—	118	
	Picture Mode	Natural	✓	✓	81, 119	
	Digital Tele-converter	Off	✓	✓	119	
	Metering		✓	✓	95	
	AF Illuminator	On	✓	✓	119	
	Image Stabilizer	S-IS On	✓	✓	93	
	Elec. Zoom Speed	Normal	✓	—	120	
		±0.0	✓	✓	92	
	Multiple Exposure	Number of Frames	Off	✓	✓	120
		Auto Gain	Off	✓	✓	
		Overlay	Off	✓	✓	
	Intrvl. Sh./Time Lapse	Off	✓	✓	122	
	Silent  Settings	Noise Reduction	Off	✓	—	123
			Not Allow	✓	—	
		AF Illuminator	Not Allow	✓	—	
Flash Mode		Not Allow	✓	—		
RC Mode	Off	✓	✓	124		

## 📺 Video Menu

Tab	Function	Default	*1	*2	👉
📺	Movie 🎤	On	✓	✓	125
	Recording Volume	±0	✓	—	125
	📺 AF Mode	C-AF	✓	✓	125
	📺 Image Stabilizer	M-IS 1	✓	✓	93
	📺 Elec. Zoom Speed	Normal	✓	—	125
	Video Frame Rate	30p	✓	—	87, 125
	Video Bit Rate	Fine	✓	—	87, 125

## ▶ Playback Menu

Tab	Function	Default	*1	*2	👉	
▶	📺	Start	—	—	—	
		BGM	On	✓	✓	
		Slide	All	✓	✓	
		Slide Interval	3 sec	✓	—	
		Movie Interval	Short	✓	—	
Edit	📺	On	✓	✓	126	
		Sel. Image	RAW Data Edit	—	—	126
			JPEG Edit	—	—	127
			Movie Edit	—	—	128, 129
			🎤	—	—	113, 127
		Image Overlay	—	—	128	
		Print Order	—	—	—	112
		Reset Protect	—	—	—	129
		Reset share Order	—	—	—	111
		Device Connection	—	—	—	143

## ⚙️ Custom Menu

Tab	Function	Default	*1	*2	👉	
⚙️	AF/MF					
	A	S-AF	mode1			
		AEL/AFL	C-AF	mode2	✓	✓
			MF	mode1		
	AF Targeting Pad	Off	✓	✓	132	
	⊖ Face Priority	👤	✓	—	73, 132	
	MF Assist	Magnify	Off	✓	—	132,
		Peaking	Off	✓	—	138
Reset Lens	On	✓	✓	132		

Tab	Function		Default	*1	*2		
	Button/Dial						
	<b>B</b>	Button Function	Function	AEL/AF-L	✓	—	101, 132
			Function	QFn	✓	—	
			Function	REC	✓	—	
		Function			✓	—	132
	Dial Function	P	Front dial:  Rear dial: Ps		✓	—	132
		A	Front dial:  Rear dial: FNo.				
		S	Front dial:  Rear dial: Shutter				
		M	Front dial: FNo. Rear dial: Shutter				
	Disp//PC						
	<b>C1</b>	Control Settings	AUTO	LV-C	✓	—	80, 133
			P/A/S/M	LV-C	✓	—	
			ART	LV-C	✓	—	
SCN/ AP			LV-C	✓	—		
Info Settings		Info	Image Only, Overall	✓	✓	133, 139	
		LV-Info	Custom1 () , Custom2 (Level Gauge)	✓	—		
		Settings	25, Calendar	✓	—		
Live View Boost		Off		✓	✓	133	
Flicker Reduction		Auto		✓	—	133	
Displayed Grid		Off		✓	—	133	
Peaking Color		Red		✓	—	133	
<b>C2</b>			On	✓	✓	133	
	HDMI	Output Size	1080p	✓	—	133,	
		HDMI Control	Off	✓	—	140	
USB Mode		Auto		✓	✓	133	
Exp/ISO/BULB							
<b>D1</b>	Exposure Shift		±0	✓	—	134	
	ISO-Auto Set	Upper Limit	6400	✓	✓	134	
		Default	200	✓	✓		
	Noise Filter		Standard		✓	✓	134
Noise Reduct.		Auto		✓	✓	62, 134	
<b>D2</b>	Bulb/Time Timer		8min	✓	✓	61, 134	
	Live Bulb		Off	✓	—	61, 134	
	Live Time		0.5 sec	✓	—	61, 134	
	Composite Settings		1 sec	✓	—	63, 134	

Tab	Function	Default	*1	*2			
	⚡ Custom						
		⚡ X-Sync.	1/250	✓	✓	135, 141	
		⚡ Slow Limit	1/60	✓	✓	135, 141	
		+	Off	✓	✓	71, 92, 135	
		⚡+WB	WB AUTO	✓	—	135	
	⏪WB/Color						
		⏪ Set	⏪-1  SF, ⏪-2  LF, ⏪-3  LN, ⏪-4  MN	✓	✓	135, 141	
		WB	Auto	✓	✓	83, 135	
		AUTO Keep Warm Color	On	✓	✓	135	
		Color Space	sRGB	✓	✓	99, 135	
	Record						
		File Name	Reset	✓	—	136	
		Edit Filename	—	✓	—	136	
		Copyright Settings	Copyright Info.	Off	✓	—	136
			Artist Name	—	—	—	
Copyright Name	—		—	—			
EVF							
	EVF Auto Switch	On	✓	—	137		
	EVF Adjust	EVF Auto Luminance	Off	✓	—	137	
		EVF Adjust	±0,  ±0	✓	—		
Utility							
	Pixel Mapping	—	—	—	137, 163		
	Level Adjust	—	✓	—	137		
	Touchscreen Settings	On	✓	—	137		
	Sleep	1 min	✓	✓	21, 137		
	Certification	—	—	—	137		



## Setup Menu

Tab	Function	Default	*1	*2		
	Card Setup	—	—	—	131	
		—	—	—	23	
		English	—	—	130, 131	
		±0,  ±0, Natural	✓	—	130	
	Rec View	0.5 sec	✓	—	130	
	Wi-Fi/Bluetooth Settings	Wireless Functions	On	✓	—	150
		Bluetooth	On	✓	—	144
		Power-off Standby	Select	✓	—	145
		Connection Password	—	—	—	150
		Reset Settings	—	—	—	149
	Firmware	—	—	—	130	



## Specifications

### ■ Camera

Product type	
Product type	Digital camera with interchangeable Micro Four Thirds Standard lens system
Lens	M.Zuiko Digital, Micro Four Thirds System Lens
Lens mount	Micro Four Thirds mount
Equivalent focal length on a 35 mm film camera	Approx. twice the focal length of the lens
Image pickup device	
Product type	4/3" Live MOS sensor
Total no. of pixels	Approx. 21.77 million pixels
No. of effective pixels	Approx. 20.30 million pixels
Screen size	17.4 mm (H) × 13.0 mm (V)
Aspect ratio	1.33 (4:3)
Viewfinder	
Type	Electronic viewfinder with eye sensor
No. of pixels	Approx. 2.36 million dots
Magnification	100%
Eye point	Approx. 19.2 mm (−1 m <sup>-1</sup> )
Live view	
Sensor	Uses Live MOS sensor
Magnification	100%
Monitor	
Product type	3.0" TFT color LCD, Vari-angle, touch screen
Total no. of pixels	Approx. 1.04 million dots (aspect ratio 3:2)
Shutter	
Product type	Computerized focal-plane shutter
Shutter speed	1/4000 - 60 sec., bulb photography, time photography
Auto focus	
Product type	Hi-Speed Imager AF
Focusing points	121 points
Selection of focusing point	Auto, Optional
Exposure control	
Metering system	TTL metering system (imager metering) Digital ESP metering/Center weighted averaging metering/Spot metering
Metered range	EV -2 - 20 (f/2.8 lens, ISO100)
Shooting modes	 : AUTO/ <b>P</b> : Program AE (Program shift can be performed)/ <b>A</b> : Aperture priority AE/ <b>S</b> : Shutter priority AE/ <b>M</b> : Manual/  : Movie/ <b>ART</b> : Art Filter/ <b>SCN</b> : Scene/  : Advanced Photo
ISO sensitivity	LOW, 200 - 25600 (1/3 EV step)
Exposure compensation	±5.0 EV (1/3 EV step)
White balance	
Product type	Image pickup device
Mode setting	Auto/Preset WB (6 settings)/Customized WB/One-touch WB (camera can store up to 4 settings)

<b>Recording</b>	
Memory	SD, SDHC and SDXC UHS-II compatible
Recording system	Digital recording, JPEG (DCF2.0), RAW Data
Applicable standards	Exif 2.31, Digital Print Order Format (DPOF)
Sound with still pictures	Wave format
Movie	MPEG-4 AVC/H.264
Audio	Stereo, PCM 48kHz
<b>Playback</b>	
Display format	Single-frame playback/Close-up playback/Index display/Calendar display
<b>Drive</b>	
Drive mode	Single-frame shooting/Sequential shooting/Self-timer/Silent shooting
Sequential shooting	Up to approximately 8.7 fps (☐H) / Up to approximately 15 fps (♥☐H)
Self-timer	Operation time: 12 sec./2 sec./Customized
Energy saving function	Switch to sleep mode: 1 minute (This function can be customized.) Power OFF: 4 hours
<b>Flash</b>	
Guide number	5.1 (ISO100•m)/7.2 (ISO200•m)
Firing angle	Covers the angle of view of a 14 mm lens (28 mm in 35 mm format)
Flash control mode	TTL-AUTO (TTL pre-flash mode)/MANUAL
Sync speed	1/250 s or slower
<b>Wireless LAN</b>	
Compatible standard	IEEE 802.11b/g/n
<b>Bluetooth®</b>	
Compatible standard	Bluetooth Version 4.2 BLE
<b>External connector</b>	
Micro-USB connector/HDMI micro connector (type D)	
<b>Power supply</b>	
Battery	Lithium-ion Battery ×1
<b>Dimensions/weight</b>	
Dimensions	121.7 mm (W) × 84.6 mm (H) × 49.0 mm (D) (4.8" × 3.3" × 1.9") (excluding protrusions)
Weight	Approx. 383 g (0.8 lb.) (including battery and memory card)
<b>Operating environment</b>	
Temperature	0 °C - 40 °C (32 °F - 104 °F) (operation)/ -20 °C - 60 °C (-4 °F - 140 °F) (storage)
Humidity	30% - 90% (operation)/10% - 90% (storage)

The terms HDMI and HDMI High-Definition Multimedia Interface, and the HDMI Logo are trademarks or registered trademarks of HDMI Licensing Administrator, Inc. in the United States and other countries.

**HDMI**™  
HIGH-DEFINITION MULTIMEDIA INTERFACE

### ■ Lithium-ion battery

MODEL NO.	BLS-50
Product type	Rechargeable Lithium ion battery
Nominal voltage	DC 7.2 V
Nominal capacity	1210 mAh
No. of charge and discharge times	Approx. 500 times (varies with usage conditions)
Ambient temperature	0 °C - 40 °C (32 °F - 104 °F) (charging)
Dimensions	Approx. 35.5 mm (W) × 12.8 mm (H) × 55 mm (D) (1.4" × 0.5" × 2.2")
Weight	Approx. 46 g (0.1 lb.)

### ■ USB-AC adapter

MODEL NO.	F-5AC-1/F-5AC-2
Rated input	AC 100V - 240V (50/60Hz)
Rated output	DC 5 V, 1500 mA
Ambient temperature	0 °C - 40 °C (32 °F - 104 °F) (operation)/ -20 °C - 60 °C (-4 °F - 140 °F) (storage)

- SPECIFICATIONS ARE SUBJECT TO CHANGE WITHOUT ANY NOTICE OR OBLIGATION ON THE PART OF THE MANUFACTURER.
- Visit our website for the latest specifications.

## SAFETY PRECAUTIONS



**CAUTION**  
RISK OF ELECTRICAL SHOCK  
DO NOT OPEN



CAUTION: TO REDUCE THE RISK OF ELECTRICAL SHOCK, DO NOT REMOVE COVER (OR BACK). NO USER-SERVICEABLE PARTS INSIDE. REFER SERVICING TO QUALIFIED OLYMPUS SERVICE PERSONNEL.



An exclamation mark enclosed in a triangle alerts you to important operating and maintenance instructions in the documentation provided with the product.



**WARNING** If the product is used without observing the information given under this symbol, serious injury or death may result.



**CAUTION** If the product is used without observing the information given under this symbol, injury may result.



**NOTICE** If the product is used without observing the information given under this symbol, damage to the equipment may result.

**WARNING!**

TO AVOID THE RISK OF FIRE OR ELECTRICAL SHOCK, NEVER DISASSEMBLE, EXPOSE THIS PRODUCT TO WATER OR OPERATE IN A HIGH HUMIDITY ENVIRONMENT.

**General Precautions**

**Read All Instructions** — Before you use the product, read all operating instructions. Save all manuals and documentation for future reference.

**Power Source** — Connect this product only to the power source described on the product label.

**Foreign Objects** — To avoid personal injury, never insert a metal object into the product.

**Cleaning** — Always unplug this product from the wall outlet before cleaning. Use only a damp cloth for cleaning. Never use any type of liquid or aerosol cleaner, or any type of organic solvent to clean this product.

**Heat** — Never use or store this product near any heat source such as a radiator, heat register, stove, or any type of equipment or appliance that generates heat, including stereo amplifiers.

**Attachments** — For your safety, and to avoid damaging the product, use only accessories recommended by Olympus.

**Location** — To avoid damage to the product, mount the product securely on a stable tripod, stand, or bracket.

**WARNING**

- **Do not use the camera near flammable or explosive gases.**
- **Rest your eyes periodically when using the viewfinder.**

Failure to observe this precaution could result in eyestrain, nausea, or sensations similar to motion sickness. The length and frequency of the required rest varies with the individual; use your own judgement. If you feel tired or unwell, avoid using the viewfinder and if necessary consult a physician.

- **Do not use the flash and LED (including AF illuminator) on people (infants, small children, etc.) at close range.**
  - You must be at least 1 m (3 ft.) away from the faces of your subjects. Firing the flash too close to the subject's eyes could cause a momentary loss of vision.
- **Do not look at the sun or strong lights with the camera.**

- **Keep young children, infants away from the camera.**
  - Always use and store the camera out of the reach of young children and infants to prevent the following dangerous situations which could cause serious injury:
    - Becoming entangled in the camera strap, causing strangulation.
    - Accidentally swallowing the battery, cards or other small parts.
    - Accidentally firing the flash into their own eyes or those of another child.
    - Accidentally being injured by the moving parts of the camera.
- **If you find that the USB-AC adapter is extremely hot or notice any unusual odors, noise, or smoke around it, unplug the power plug from wall outlet immediately and stop using it. Then, contact an authorized distributor or service center.**
- **Stop using the camera immediately if you notice any unusual odors, noise, or smoke around it.**
  - Never remove the batteries with bare hands, which may cause a fire or burn your hands.
- Never hold or operate the camera with wet hands. This may cause overheating, exploding, burning, electrical shocks, or malfunctions.
- **Do not leave the camera in places where it may be subject to extremely high temperatures.**
  - Doing so may cause parts to deteriorate and, in some circumstances, cause the camera to catch fire. Do not use the charger or USB-AC adapter if it is covered (such as a blanket). This could cause overheating, resulting in fire.
- **Handle the camera with care to avoid getting a low temperature burn.**
  - When the camera contains metal parts, overheating can result in a low-temperature burn. Pay attention to the following:
    - When used for a long period, the camera will get hot. If you hold on to the camera in this state, a low-temperature burn may be caused.
    - In places subject to extremely cold temperatures, the temperature of the camera's body may be lower than the environmental temperature. If possible, wear gloves when handling the camera in cold temperatures.
- To protect the high-precision technology contained in this product, never leave the camera in the places listed below, no matter if in use or storage:
  - Places where temperatures and/or humidity are high or go through extreme changes. Direct sunlight, beaches, locked cars, or near other heat sources (stove, radiator, etc.) or humidifiers.
  - In sandy or dusty environments.
  - Near flammable items or explosives.
  - In wet places, such as bathrooms or in the rain.
  - In places prone to strong vibrations.
- The camera uses a lithium ion battery specified by Olympus. Charge the battery with the specified USB-AC adapter or charger. Do not use any other USB-AC adapters or chargers.
- Never incinerate or heat batteries in microwaves, on hot plates, or in pressure vessels, etc.
- Never leave the camera on or near electromagnetic devices. This may cause overheating, burning, or exploding.
- Do not connect terminals with any metallic objects.
- Take precautions when carrying or storing batteries to prevent them from coming into contact with any metal objects such as jewelry, pins, fasteners, keys, etc. The short circuit may cause overheating, exploding, or burning, which burn or damage you.
- To prevent causing battery leaks or damaging their terminals, carefully follow all instructions regarding the use of batteries. Never attempt to disassemble a battery or modify it in any way, solder, etc.
- If battery fluid gets into your eyes, flush your eyes immediately with clear, cold running water and seek medical attention immediately.
- If you cannot remove the battery from the camera, contact an authorized distributor or service center. Do not try to remove the battery by force. Damage to the battery exterior (scratches, etc.) may produce heat or an explosion.
- Always store batteries out of the reach of small children and pets. If they accidentally swallow a battery, seek medical attention immediately.
- To prevent batteries from leaking, overheating, or causing a fire or explosion, use only batteries recommended for use with this product.

- If rechargeable batteries have not been recharged within the specified time, stop charging them and do not use them.
- Do not use batteries with scratches or damage to the casing, and do not scratch the battery.
- Never subject batteries to strong shocks or continuous vibration by dropping or hitting. This may cause exploding, overheating, or burning.
- If a battery leaks, has unusual odor, becomes discolored or deformed, or becomes abnormal in any other way during operation, stop using the camera, and keep away from fire immediately.
- If a battery leaks fluid onto your clothing or skin, remove the clothing and flush the affected area with clean, running cold water immediately. If the fluid burns your skin, seek medical attention immediately.
- Never use lithium-ion batteries in a low-temperature environment. Doing so may cause generation of heat, ignition, or explosion.
- The Olympus lithium-ion battery is designed to be used only for the Olympus digital camera. Do not use the battery to other devices.
- **Do not allow children or animals/pets to handle or transport batteries (prevent dangerous behaviour such as licking, putting in mouth or chewing).**

## Use Only Dedicated Rechargeable Battery, Battery Charger and USB-AC adapter

We strongly recommend that you use only the genuine Olympus dedicated rechargeable battery, battery charger and USB-AC adapter with this camera. Using a non-genuine rechargeable battery, battery charger and/or USB-AC adapter may result in fire or personal injury due to leakage, heating, ignition or damage to the battery. Olympus does not assume any liability for accidents or damage that may result from the use of a battery, battery charger and/or USB-AC adapter that are not genuine Olympus accessories.

### CAUTION

- **Do not cover the flash with a hand while firing.**
- The included USB-AC adapter F-5AC is designed to be used only with this camera. Other cameras cannot be charged with this USB-AC adapter.
- Do not connect the included USB-AC adapter F-5AC to equipment other than this camera.
- Never store batteries where they will be

exposed to direct sunlight, or subjected to high temperatures in a hot vehicle, near a heat source, etc.

- Keep batteries dry at all times.
- The battery may become hot during prolonged use. To avoid minor burns, do not remove it immediately after using the camera.
- This camera uses one Olympus lithium-ion battery. Use the specified genuine battery. There is a risk of explosion if the battery is replaced with the incorrect battery type.
- Please recycle batteries to help save our planet's resources. When you throw away dead batteries, be sure to cover their terminals and always observe local laws and regulations.

### NOTICE

- **Do not use or store the camera in dusty or humid places.**
- **Use SD/SDHC/SDXC memory cards only. Never use other types of cards.** If you accidentally insert another type of card into the camera, contact an authorized distributor or service center. Do not try to remove the card by force.
- Regularly back up important data to a computer or other storage device to prevent accidental loss.
- OLYMPUS accepts no liability for any loss of data associated with this device.
- Be careful with the strap when you carry the camera. It could easily catch on stray objects and cause serious damage.
- Before transporting the camera, remove a tripod and all other non-OLYMPUS accessories.
- Never drop the camera or subject it to severe shocks or vibrations.
- When attaching the camera to or removing it from a tripod, rotate the tripod screw, not the camera.
- Do not touch electric contacts on cameras.
- Do not leave the camera pointed directly at the sun. This may cause lens or shutter curtain damage, color failure, ghosting on the image pickup device, or may possibly cause fires.
- Do not leave the viewfinder exposed to a strong light source or direct sunlight. The heat may damage the viewfinder.
- Do not push or pull severely on the lens.
- Be sure to remove any water droplets or other moisture from the product before replacing the battery or opening or closing covers.
- Before storing the camera for a long period, remove the batteries. Select a cool, dry

location for storage to prevent condensation or mold from forming inside the camera. After storage, test the camera by turning it on and pressing the shutter button to make sure that it is operating normally.

- The camera may malfunction if it is used in a location where it is subject to a magnetic/electromagnetic field, radio waves, or high voltage, such as near a TV set, microwave, video game, loud speakers, large monitor unit, TV/radio tower, or transmission towers. In such cases, turn the camera off and on again before further operation.
- Always observe the operating environment restrictions described in the camera's manual.
- Insert the battery carefully as described in the operating instructions.
- Before loading, always inspect the battery carefully for leaks, discoloration, warping, or any other abnormality.
- Always unload the battery from the camera before storing the camera for a long period.
- When storing the battery for a long period, select a cool location for storage.
- For plug-in type USB-AC adapter: Connect the plug-in type USB-AC adapter F-5AC correctly by plugging it vertically into the wall outlet.
- Power consumption by the camera varies depending on which functions are used.
- During the conditions described below, power is consumed continuously and the battery becomes exhausted quickly.
  - The zoom is used repeatedly.
  - The shutter button is pressed halfway repeatedly in shooting mode, activating the auto focus.
  - A picture is displayed on the monitor for an extended period of time.
- Using an exhausted battery may cause the camera to turn off without displaying the battery level warning.
- If the battery's terminals get wet or greasy, camera contact failure may result. Wipe the battery well with a dry cloth before use.
- Always charge a battery when using it for the first time, or if it has not been used for a long period.
- When operating the camera with battery power at low temperatures, try to keep the camera and spare battery as warm as possible. A battery that has run down at low temperatures may be restored after it is warmed at room temperature.
- Before going on a long trip, and especially before traveling abroad, purchase extra batteries. A recommended battery may be

difficult to obtain while traveling.

## Using the wireless LAN/Bluetooth® functions

- **Turn off the camera in hospitals and other locations where medical equipment is present.**

The radio waves from the camera may adversely affect medical equipment, causing a malfunction that results in an accident. Be sure to disable wireless LAN/Bluetooth® functions in the vicinity of medical equipment (P. 150).

- **Turn off the camera when onboard aircraft.** Using wireless devices onboard may hinder safe operation of the aircraft. Be sure to disable wireless LAN/Bluetooth® functions onboard aircraft (P. 150).

## Monitor

- Do not push the monitor forcibly; otherwise the image may become vague, resulting in a playback mode failure or damage to the monitor.
- A strip of light may appear on the top/bottom of the monitor, but this is not a malfunction.
- When a subject is viewed diagonally in the camera, the edges may appear zigzagged on the monitor. This is not a malfunction; it will be less noticeable in playback mode.
- In places subject to low temperatures, the monitor may take a long time to turn on or its color may change temporarily. When using the camera in extremely cold places, it is a good idea to occasionally place it in a warm place. The monitor exhibiting poor performance due to low temperatures will recover in normal temperatures.
- The monitor of this product is manufactured with high-quality accuracy, however, there may be a stuck or dead pixel on the monitor. These pixels do not have any influence on the image to be saved. Because of the characteristics, the unevenness of the color or brightness may also be found depending on the angle, but this is due to the structure of the monitor. This is not a malfunction.

## Legal and Other Notices

- Olympus makes no representations or warranties regarding any damages, or benefit expected by using this unit lawfully, or any request from a third person, which are caused by the inappropriate use of this product.
- Olympus makes no representations or warranties regarding any damages or any benefit expected by using this unit lawfully which are caused by erasing picture data.

## Disclaimer of Warranty

- Olympus makes no representations or warranties, either expressed or implied, by or concerning any content of these written materials or software, and in no event shall be liable for any implied warranty of merchantability or fitness for any particular purpose or for any consequential, incidental or indirect damages (including but not limited to damages for loss of business profits, business interruption and loss of business information) arising from the use or inability to use these written materials or software or equipment. Some countries do not allow the exclusion or limitation of liability for consequential or incidental damages or of the implied warranty, so the above limitations may not apply to you.
- Olympus reserves all rights to this manual.

## Warning

Unauthorized photographing or use of copyrighted material may violate applicable copyright laws. Olympus assumes no responsibility for unauthorized photographing, use or other acts that infringe upon the rights of copyright owners.

## Copyright Notice

All rights reserved. No part of these written materials or this software may be reproduced or used in any form or by any means, electronic or mechanical, including photocopying and recording or the use of any type of information storage and retrieval system, without the prior written permission of Olympus. No liability is assumed with respect to the use of the information contained in these written materials or software, or for damages resulting from the use of the information contained therein. Olympus reserves the right to alter the features and contents of this publication or software without obligation or advance notice.

## Trademarks

- Microsoft and Windows are registered trademarks of Microsoft Corporation.
- SDXC Logo is a trademark of SD-3C, LLC.
- Apical logo is a registered trademark of Apical Limited.
- Micro Four Thirds, Four Thirds, and the Micro Four Thirds and Four Thirds logos are trademarks or registered trademarks of the OLYMPUS CORPORATION in Japan, the United States, the countries of the European Union, and other countries.
- Wi-Fi is a registered trademark of the Wi-Fi Alliance.



- The Wi-Fi CERTIFIED logo is a certification mark of the Wi-Fi Alliance.
- The Bluetooth® word mark and logos are registered trademarks owned by the Bluetooth SIG, Inc. and any use of such marks by OLYMPUS CORPORATION is under license.
- The standards for camera file systems referred to in this manual are the "Design Rule for Camera File System/DCF" standards stipulated by the Japan Electronics and Information Technology Industries Association (JEITA).
- All other company and product names are registered trademarks and/or trademarks of their respective owners.



THIS PRODUCT IS LICENSED UNDER THE AVC PATENT PORTFOLIO LICENSE FOR THE PERSONAL AND NONCOMMERCIAL USE OF A CONSUMER TO (i) ENCODE VIDEO IN COMPLIANCE WITH THE AVC STANDARD ("AVC VIDEO") AND/OR (ii) DECODE AVC VIDEO THAT WAS ENCODED BY A CONSUMER ENGAGED IN A PERSONAL AND NON-COMMERCIAL ACTIVITY AND/OR WAS OBTAINED FROM A VIDEO PROVIDER LICENSED TO PROVIDE AVC VIDEO. NO LICENSE IS GRANTED OR SHALL BE IMPLIED FOR ANY OTHER USE. ADDITIONAL INFORMATION MAY BE OBTAINED FROM MPEG LA, L.L.C. SEE [HTTP://WWW.MPEGLA.COM](http://www.MPEGLA.COM)

The software in this camera may include third party software. Any third party software is subject to the terms and conditions, imposed by the owners or licensors of that software, under which software is provided to you.

Those terms and other third party software notices, if any, may be found in the software notice PDF file stored at <http://www.olympus.co.jp/en/support/imgs/digicamera/download/notice/notice.cfm>



# Index

## Numbers

■) (Beep sound) .....	133
⚡ Slow Limit .....	135, 141
⚡+WB .....	135
⚡ X-Sync .....	135, 141
⚡ RC Mode .....	158
🔒 (Protect) .....	110
📺 (Monitor brightness adjustment) .....	130
🎞 Mode (movie exposure mode) .....	91
📺 (Index display) .....	115, 139
✂ (Trimming) .....	127
📺/Info Settings .....	133, 139
🔍+📺 .....	135
📺/🕒 .....	77
📺 (Index display/Calendar display) .....	108
🗣 (language) .....	130
📺 (One-touch white balance) ..	101, 102
🗑 (Single-frame erase) .....	110
👤 (Face priority AF) .....	73
🔒 Keep Warm Color .....	135
📺 (Preview) .....	102
📺 (Sequential Low) .....	77
📺 (Sequential High) .....	77
📺 Info .....	133
📺 Settings .....	133
📺 Control Settings .....	133
⚡ UP .....	75, 158
📺 (Shortcut) Button .....	33
🎞 (Movie) button .....	65, 101, 132
✓ (Image selection) .....	111
🔍 (Close-up playback) .....	108
📺 (Image rotation) .....	126

## A

A (Aperture priority mode) .....	56
Accessories .....	159
AdobeRGB .....	99
Advanced photo mode .....	40
AE Bracketing .....	48

AEL/AFL .....	138
AE lock .....	102, 132, 138
AF Area .....	72
AF illuminator .....	30, 119
AF Mode .....	84
Movie .....	125
AF Targeting Pad .....	132
AF target settings .....	72
AF tracking .....	85
AP Mode .....	40
<b>ART</b> (Art filter) .....	50
Aspect ratio .....	86
Audio recording .....	
Still image .....	113
AUTO mode (📺) .....	34

## B

Backlight HDR .....	38
Battery charge .....	17
Battery level .....	21
Beep sound .....	133
Bleach Bypass .....	52
<b>Bluetooth</b> ® .....	142
Bulb .....	61
BULB .....	61
Bulb/Time Timer .....	134
Button Function .....	101

## C

C-AF (Continuous AF) .....	84
C-AF+TR (AF tracking) .....	85
Calendar display .....	108, 115, 139
Card .....	15, 154
Card Setup .....	131
Certification .....	137
Close-up playback .....	108
Color Creator .....	82
Color Filter .....	97
Color Space .....	99, 135
Composite Settings .....	134
Compression rate .....	86, 141, 154

Computer.....	151
Connection	
Computer.....	151
Smartphone.....	142
Continuous AF.....	84
Contrast.....	96
Control Settings.....	133
Copyright Settings.....	136
Custom Menu.....	132, 170

## D

Date/time setting (🕒).....	22
Dial Function.....	132
Digital Tele-converter.....	71, 119
Diopter adjustment dial.....	25
Displayed Grid.....	133
DPOF.....	112

## E

Edit.....	126
Edit Filename.....	136
Effect (i-Enhance).....	98
Elec. Zoom Speed	
Movie.....	125
Still image.....	120
Erase	
All images.....	131
Selected images.....	111
Single-frame.....	110
EVF Adjust.....	137
EVF Auto Switch.....	137
Exif data.....	136
Exposure compensation.....	71
Exposure Shift.....	134
External flash units.....	157
Eye priority AF.....	73

## F

Face priority AF.....	73
File format.....	154
File Name.....	136
File size.....	154
Fine-Tune.....	53
Firmware.....	130

Flash.....	75
Flash intensity control.....	92
Flicker Reduction.....	133
Fn button.....	101
Focus Bracketing.....	49
Focus mode.....	84
Focus ring.....	84
Format.....	131

## G

GPS log.....	149
Gradation.....	97

## H

HDMI.....	133, 140
HDR.....	44
Highlight&Shadow Control.....	100
Histogram display.....	28

## I

Image aspect.....	86
Image Overlay.....	128
Image quality	
Movie (🎞️👁️).....	87
Still image (📷👁️).....	86
Image quality settings	
Movie.....	87
Still image.....	86, 135, 154
Still image (👁️- Set).....	141
Image size	
Movie.....	87
Still image.....	135, 141, 154
Image Stabilizer.....	93
Movie.....	125
Image transfer to smartphone.....	147
Index display.....	108, 115, 139
<b>INFO</b> button.....	28, 106, 117
Information display.....	26
Playback.....	105
In-Movie Image Capture.....	128
Installation.....	152
Instant Film.....	52
Interchangeable lenses.....	155
ISO-Auto Set.....	134

ISO sensitivity ..... 74

## K

Keystone Compensation ..... 47

## L

Language setting (  ) ..... 130

Level Adjust ..... 137

Level gauge ..... 28

Light Trails ..... 37

Live Bulb ..... 61, 134

Live composite photography ..... 41, 63

Live control ..... 79

Live Time ..... 61

LIVE TIME ..... 42, 61

Live View Boost ..... 133

Long time exposure  
(BULB/LIVE TIME) ..... 61

LV-Info ..... 133, 139

LV super control panel ..... 80

## M

M (Manual mode) ..... 60

Manual focus ..... 84

Manual focus clutch (MF clutch) ..... 156

Menu ..... 117, 169

Metering ..... 95

MF Assist ..... 132, 138

MF (Button Function) ..... 102

MF Clutch ..... 156

MF (Manual focus) ..... 84

Mode dial ..... 29

Monitor brightness adjustment ..... 130

Monochrome Color ..... 98

Movie  ..... 125

Movie exposure mode ..... 91

Movie mode ..... 67

Movie shooting ..... 65

Movie Trimming ..... 129

Multiple Exposure ..... 43, 120

## N

Noise Filter ..... 134

Noise Reduct. .... 134

Number of storable still pictures ..... 154

## O

OI.Palette ..... 142

OI.Share ..... 142

OI.Track ..... 142

Olympus Workspace ..... 2, 152

One-touch white balance (  ) ..... 84, 102

## P

P (Program mode) ..... 54

Panorama ..... 46, 114

Partial Color ..... 53

PC software ..... 152

Peaking ..... 102, 138

Peaking Color ..... 133

Picture Mode ..... 81, 119

Pixel Count ..... 141, 154

Pixel mapping ..... 137, 163

Playback

    Movie ..... 107, 110

    Still image ..... 107

Playback Menu ..... 126, 170

Position information ..... 149

Preview (  ) ..... 102

Program shift (Ps) ..... 55

Protect ..... 110

Ps (Program shift) ..... 55

## R

Radio-Controlled Flash

    Photography ..... 157

RAW Data Edit ..... 126

RAW image ..... 86

RC Mode (  RC Mode ) ..... 158

Recording Volume ..... 125

Rec View ..... 130

Remote shooting ..... 148

Reset ..... 118

Reset Lens ..... 132

Reset Protect.....	129
Rotate.....	108

## S

S (Shutter priority mode).....	58
S-AF+MF (Single AF and Manual focus).....	85
S-AF (Single AF).....	84
Saturation.....	96
<b>SCN</b> (Scene).....	36
SD card.....	154
Formatting the card.....	131
Self-portraits.....	69
Self-timer.....	77
Sequential shooting.....	77
Setup Menu.....	130, 172
Share Order.....	111
Sharpness.....	95
Shooting Menu.....	118, 169
Shooting Menu 1.....	118
Shooting Menu 2.....	118
Shooting modes.....	29
Silent [♥].....	38, 45, 78
Silent [♥] Settings.....	123
Single AF.....	84
Sleep.....	21, 137
Slow-motion movie.....	68
sRGB.....	99
Storage.....	151
Super Spot AF.....	103

## T

Time.....	61
Time Lapse Movie.....	122
Time lapse shooting.....	122
Touch screen operations.....	32, 115
Touchscreen Settings.....	137
TV.....	140

## U

USB Mode.....	133
User registration.....	2

## V

Video Bit Rate.....	87, 125
---------------------	---------

Video Frame Rate.....	87, 125
Video Menu.....	125, 170
Volume adjustment.....	110

## W

WB.....	135
White balance.....	83
White balance compensation.....	94
Wi-Fi/Bluetooth Settings .....	130, 144, 145, 149, 150
Wireless Remote Control Flash.....	158

## Z

Zoom frame AF.....	103
--------------------	-----

**OLYMPUS KOREA CO., LTD.**

2F-3F Majestar City 1, 12, Seocho-daero 38-gil, Seocho-gu, Seoul,  
06655, Republic of Korea  
Tel. 1544-3200  
E-mail: [hotline.okr@olympus-ap.com](mailto:hotline.okr@olympus-ap.com)  
<http://www.olympus.co.kr>

**OLYMPUS (MALAYSIA) Sdn Bhd**

512, 5th Floor, Block D, Kelana Square 17, Jalan SS 7/26, Kelana Jaya,  
47301 Petaling Jaya, Selangor, Malaysia  
Tel: (603) 7806 2173  
Fax: (603) 7803 7164  
E-mail: [service.oml@olympus-ap.com](mailto:service.oml@olympus-ap.com)  
<http://www.olympus.com.my>

**OLYMPUS (Thailand) CO., LTD.**

23/112 Sorachai Building, 27th Floor, Soi Sukhumvit 63 (Ekamai)  
Sukhumvit road Klongton Nua, Wattana, Bangkok 10110 Thailand  
Tel: (66) 2-000-7700  
E-mail: [imaging.oth@olympus-ap.com](mailto:imaging.oth@olympus-ap.com)

## **OLYMPUS AMERICA INC.**

3500 Corporate Parkway, P.O. Box 610, Center Valley, PA 18034-0610, U.S.A. Tel. 484-896-5000

### **Technical Support (U.S.A. / Canada)**

24/7 online automated help:

<http://www.olympusamerica.com/support>

Phone customer support:

Tel. 1-800-260-1625 (Toll-free)

Our phone customer support is available from 9 am to 9 pm (Monday to Friday) ET

<http://olympusamerica.com/contactus>

Olympus software updates can be obtained at:

<http://www.olympusamerica.com/digital>

## **OLYMPUS EUROPA SE & CO. KG**

Premises: Consumer Product Division  
Wendenstrasse 14-18, 20097  
Hamburg, Germany

Tel: +49 40-23 77 3-0 / Fax: +49 40-23 07 61

Goods delivery: Modul H, Willi-Bleicher Str. 36,  
52353 Düren, Germany

Mailing address: Postfach 10 49 08,  
20034 Hamburg, Germany

### **European Technical Customer Support:**

Please visit our homepage <http://www.olympus-europa.com> or call our TOLL FREE NUMBER\* :  
**00800 - 67 10 83 00**

for Austria, Belgium, Denmark, Finland, France, Germany, Luxemburg, Netherlands, Norway,  
Poland, Portugal, Spain, Sweden, Switzerland, United Kingdom.

810-800 67 10 83 00 for Russia

800 167 777 for Czech Republic

\* Please note some phone service providers do not permit access to 00800 numbers or require an additional prefix. Charges may apply here. Please contact your service provider directly for more details.

For all not listed European Countries and in case that you can't get connected to the above mentioned number, please make use of the following CHARGED NUMBERS **+49 40 - 237 73 899**

## **OLYMPUS (BEIJING) SALES & SERVICE CO.,LTD**

Customer Support: 400-650-0303 Homepage: <http://olympus-imaging.cn>

### **Customer Service Center:**

10F, K, Wah Centre, 1010 Huaihai Road(M), Xuhui District, Shanghai

Zip: 200031

## **OLYMPUS HONG KONG AND CHINA LIMITED**

Digital Camera Repair Centre

L4207, Office Tower, Langham Place, 8 Argyle Street, Mongkok, Kowloon, Hong Kong

Customer Hotline: +852-2376-2150 Fax: +852-2375-0630

E-mail: [cs.ohc@olympus-ap.com](mailto:cs.ohc@olympus-ap.com)

<http://www.olympus.com.hk>