

SONY

Television BRAVIA 9 / BRAVIA 8 / BRAVIA 8 II / BRAVIA 7 / BRAVIA 5 / A95L

Getting Started

Installation

Remote control

- [Voice Remote Control \[1\]](#)
- [IR Remote Control \[2\]](#)
- [Available types of remote control \[3\]](#)

Connecting terminal

How the LEDs light up

Home menu

Selecting inputs

Performing acoustic auto calibration

Accessibility features

Useful features

Searching for content/operating the TV with your voice

- [Using the Voice Remote Control microphone](#) [4]
- [Using the built-in MIC on the TV \(only TVs with a built-in MIC\)](#) [5]

Selecting the Content type based on the current content

Game Menu

Enjoying apps

- [Installing apps](#) [6]
- [Enjoying safe apps and video streaming services \(Security and restrictions\)](#) [7]
- [Viewing Internet content](#) [8]

BRAVIA Connect App

Finding the Voice Remote Control (only models supplied with a buzzer built-in Voice Remote Control)

Using the Camera and Microphone Unit

Available features

Watching TV

Watching TV programmes

- [Watching Live TV](#) [9]
- [Using the programme guide](#) [10]
- [Receiving digital broadcasts](#) [11]
- [Receiving satellite broadcasts](#) [12]

- [Sorting or editing the channels \[13\]](#)
- [Using the TV menu \[14\]](#)
- [Using interactive broadcast TV services \[15\]](#)
- [Using the Timeshift feature \[16\]](#)

Useful features when watching TV

Adjusting the picture/screen/sound quality to your preferences

- [Adjusting the picture quality \[17\]](#)
- [Adjusting the screen \[18\]](#)
- [Adjusting the sound quality \[19\]](#)
- [Advanced auto volume \[20\]](#)
- [Balance \[21\]](#)
- [Adjusting the picture/sound quality automatically \[22\]](#)

Display subtitles

Recording TV Programmes

Recording to a USB HDD device

- [Registering a USB HDD device \[23\]](#)
- [Timer recording \[24\]](#)
- [Information about using a USB HDD device for recording \[25\]](#)

Watching/deleting recorded content

Understanding the symbols displayed in the recorded title list

Using the TV with Other Devices

USB devices

- [Playing content stored on a USB device \[26\]](#)
- [Information about USB devices used for storing photos and music \[27\]](#)

TV box, Blu-ray and DVD players

- [Connecting a TV box, Blu-ray or DVD player \[28\]](#)
- [Watching Blu-ray and DVD discs \[29\]](#)
- [How to control the TV box using the TV remote control \[30\]](#)

Smartphones and tablets

- [Displaying the iPhone/smartphone or iPad/tablet app screen on the TV \[31\]](#)
- [BRAVIA Connect App \[32\]](#)

Computers, cameras, and camcorders

- [Connecting a computer and viewing stored content \[33\]](#)
- [Connecting a camera or camcorder and viewing stored content \[34\]](#)
- [Computer video signal specifications \[35\]](#)

Audio system (such as an AV receiver or sound bar)

- [Outputting audio from an audio system \[36\]](#)
- [Connecting an audio system \[37\]](#)
- [Adjusting an audio system \[38\]](#)
- [Using the TV as a centre speaker \[39\]](#)
- [Audio formats \[40\]](#)
- [Accessing audio system settings \[41\]](#)

Video game consoles

Experiencing 3D surround with a neckband speaker or headphones

Bluetooth devices (such as Bluetooth headphones)

- [Connecting a Bluetooth device \(such as Bluetooth headphones\)](#) [42]
- [Supported Bluetooth profiles](#) [43]

Adjusting the AV sync setting

BRAVIA Sync-compatible devices

- [BRAVIA Sync overview](#) [44]
- [Using features available for BRAVIA Sync-compatible devices](#) [45]
- [Adjusting BRAVIA Sync settings](#) [46]

Viewing pictures in 4K from compatible devices

- [Viewing pictures in 4K resolution](#) [47]
- [Settings for viewing pictures through HDMI input with higher quality](#) [48]

BRAVIA Connectivity Guide

Supported files and formats

- [Photos](#) [49]
- [Music](#) [50]
- [Videos](#) [51]
- [Audio sampling rates \(for videos\)](#) [52]
- [External subtitles](#) [53]

Available devices and settings

Connecting to a Network

Connecting to a network

- [Connecting to a network using a LAN cable \[54\]](#)
- [Connecting to a network using Wi-Fi \[55\]](#)

Home network features

- [Adjusting home network settings \[56\]](#)
- [Playing content from a computer \[57\]](#)

Settings

Using the Quick Settings

Using the Eco Dashboard

Channels & Inputs

Display & Sound

Network and Internet

Accounts and sign-in

Privacy

Apps

System

Remotes and accessories

Help and feedback

Timers & Clock

Available Settings

Troubleshooting

Reset (restart) your TV

Software updates

Self diagnostics

Frequently Asked Questions for Troubleshooting

Others

About the Help Guide

Specifications

Support Site

Keeping the TV updated

Factory data reset

Trademark information

[1] Getting Started

Installation

Refer to the paper manuals supplied with your TV for installation, terminal, and wall mounting information.

Manuals are available on the support site.

[2] Getting Started | Remote control

Voice Remote Control

The supplied Voice Remote Control, button layout, button names and available features vary depending on your model/country/region.

Upper buttons on the Voice Remote Control



(Power)

Turns on or switches to standby/networked standby mode.

TV

Switch to a TV channel or input and display the TV menu. For details, refer to [Using the TV menu](#) page.

● (MIC)

Speak into here to use the microphone in the Voice Remote Control. There is an LED above the microphone.

🔑 (Quick Settings)

Display Quick Settings. For details, refer to [Using the Quick Settings](#) page.

Hint

- You can use the convenient [Find remote] feature to find the Voice Remote Control by pressing the Power button on the TV. For details, refer to [Finding the Voice Remote Control \(only models supplied with a buzzer built-in Voice Remote Control\)](#).

→ (Input select)

Display and select the input source, etc. For details, refer to the [Selecting inputs](#) page.

MENU

Access functions from the onscreen menu.

▲ (Up) / ▼ (Down) / ◀ (Left) / ▶ (Right) / -⏏- (Enter) (Navigation D-Pad)

On screen menu navigation and selection.

↶ (BACK)

Return to the previous screen.

🏠 (HOME)

Display the TV Home Menu. For details, refer to the [Home menu](#) page.

Lower buttons on the Voice Remote Control



+/- (Volume)

Adjust the volume.

(Google Assistant/Microphone)

Ask Google Assistant for a little help on the big screen. Press the Google Assistant (or MIC) button on the remote to get started.

For details, refer to the [Using the Voice Remote Control microphone](#) page.

Google Assistant is not available in certain languages/countries/regions.

(Mute)

Mute the sound. Press again to restore the sound.

Hint

- The accessibility shortcut service can be turned on or off by pressing and holding  (Mute) for 3 seconds.

CH +/- (Channel)

Select the channel.

(Dashboard)

Display Dashboard.

(Play) / (Pause)

Operate media contents on the TV and connected BRAVIA Sync-compatible device.

(Guide)

Display the digital programme guide of the TV or TV box. For details, refer to the [Using the programme guide](#) page.

App buttons (Online service)



Enjoy various streaming services by the single press of a button.

How to mute the Voice Remote Control operation sound

1. Press the  (Quick Settings) button on the Voice Remote Control, and select the following in order to disable them.
[Settings] — [System] — [System sounds]

How to disable the Voice Remote Control backlight (only Voice Remote Control that feature backlight)

You can turn off the Voice Remote Control backlight.

1. Press and hold the  (Volume) - button and then  (HOME) button on the Voice Remote Control for 2 seconds.
Release when the MIC LED on the Voice Remote Control lights up twice.
To enable the Voice Remote Control backlight again, perform the procedure above.

How to charge the Voice Remote Control (rechargeable Voice Remote Control)

The included Voice Remote Control is equipped with a rechargeable battery. Follow the steps below to charge the battery when necessary.

1. Connect the included USB cable to the Voice Remote Control.

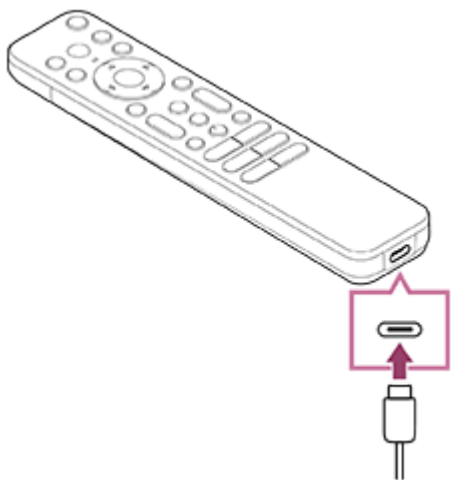

2. Connect the USB cable to your USB mains adaptor.
The LED above the microphone lights up red when charging starts.

Note

- In a high or low temperature, the charging speed may become slow or charging may stop, which will make charging inefficient. We recommend that you charge

the battery in an environment where the ambient temperature is between 15°C ~ 35°C.

It takes approximately two hours to fully charge the battery from the empty state.

The time it takes to fully charge may change depending on usage conditions.

- If the Voice Remote Control is not used for a long period of time, it may not be able to be charged due to over-discharge. Charge the battery at least once every six months.
- Do not get the USB terminal wet. Do not use or charge the battery in wet conditions. In addition, avoid fog, sand, dust, and static electricity while using it.
- When charging, use the following equipment that can supply an output current of 0.5 A (500 mA) or more.

Commercially available USB mains adaptor

A computer equipped with a USB terminal as standard (We do not guarantee the charging operation of the Voice Remote Control on all computers.)

In addition, do not use a USB mains adaptor with a maximum output exceeding 13W (5V, 2.6A).



- When charging, only use the included USB cable, and be sure to connect the Voice Remote Control directly to your computer or charger. If you connect it via a USB hub, etc., a charging failure may occur.

Hint

- If the battery power drops to a low level, it will be indicated by a lamp or buzzer as follows.

30% or less: When you press the Power button, the lamp on the Voice Remote Control flashes red.

10% or less: When you press the Power button, the lamp on the Voice Remote Control flashes red and the buzzer sounds.

You can turn the buzzer off/on by holding down the  (BACK) button while pressing the  (Volume) - button.

- You can check the remaining battery power level with the following settings.
[Settings] — [Remotes and accessories] — [Remote control]

The remaining charge which is displayed may differ from the actual remaining charge in some cases. Use it as a rough estimate.

- If you charge the Voice Remote Control after not using it for a long period of time, the lamp on the Voice Remote Control may not light up right away.

About replacing the Voice Remote Control battery (battery-type Voice Remote Control)

- Open the Voice Remote Control cover as shown below.
- Remove the Voice Remote Control cover and replace the batteries with new ones.
- Check that the orientation of each battery matches the positive (+) and negative (-) symbols in the battery compartment.

Sliding type

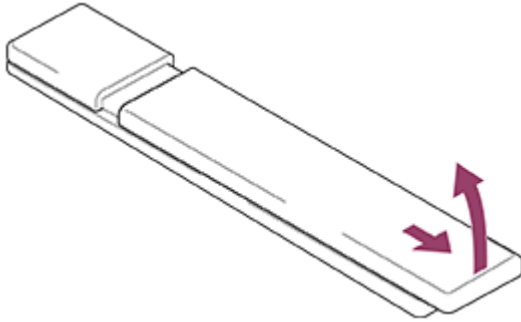

[3] Getting Started | Remote control

IR Remote Control

The included remote control, as well as the layout of the buttons and the button names, vary depending on your model/country/region.

Upper buttons on the remote control



i+ (Info/Text reveal)

Display information.

TV

Switch to a TV channel or input and display the TV menu. For details, refer to [Using the TV menu page](#).

⏻ (Power)

Turns on or switches to standby/networked standby mode.

(Subtitle setting)

Turn subtitles on or off (when the feature is available).

AUDIO

Select multilingual source sound or dual sound for the programme currently being viewed (depending on programme source).

HELP

Display the Help menu. Help Guide can be accessed from here.

EXIT

Return to the previous screen or exit from the menu. When an Interactive Application service is available, press to exit from the service.

Number Button/ • (Dot)

Use with the 0-9 buttons to select digital channels.

(Text)

Display text information.

Colour buttons

Execute corresponding function at that time.

Lower buttons on the remote control



(Input select)

Display and select the input source, etc. For details, refer to the [Selecting inputs](#) page.

(Quick Settings)

Display Quick Settings. For details, refer to the [Using the Quick Settings](#) page.

▲ (Up) / ▼ (Down) / ◀ (Left) / ▶ (Right) / -|- (Enter) (Navigation D-Pad)

On screen menu navigation and selection.

↶ (BACK)

Return to the previous screen.

🏠 (HOME)

Display the TV Home Menu. For details, refer to the [Home menu](#) page.

MENU

Display a menu on the TV to use button functions that are not on the remote control on the screen.

📶 +/- (Volume)

Adjust the volume.

↺↻ (Jump)

Jump back and forth between two channels or inputs. The TV alternates between the current channel or input and the last channel or input that was selected.

🔇 (Mute)

Mute the sound. Press again to restore the sound.

Hint

- The accessibility shortcut service can be turned on or off by pressing and holding **🔇 (Mute)** for 3 seconds.

CH +/- (Channel)

In TV mode: Select the channel.

In Text mode: Select the **⏪ (Next)** or **⏩ (Previous)** page.

⚙️ (Dashboard)

Display Dashboard.

▶ (Play) / ◀◀ (Fast rewind) / ⏸ (Pause) / ■ (Stop) / ▶▶ (Fast forward)

Operate media contents on the TV and connected BRAVIA Sync-compatible device.

(Guide)

Display the digital programme guide of the TV or TV box. For details, refer to [Using the programme guide](#) page.

How to mute the remote control operation sound

1. Press the  (Quick Settings) button on the remote control, and select the following in order to disable them.
[Settings] — [System] — [System sounds]

About replacing the remote control battery

- Open the remote control cover as shown below.
- Remove the remote control cover and replace the batteries with new ones.
- Check that the orientation of each battery matches the positive (+) and negative (-) symbols in the battery compartment.

Sliding type

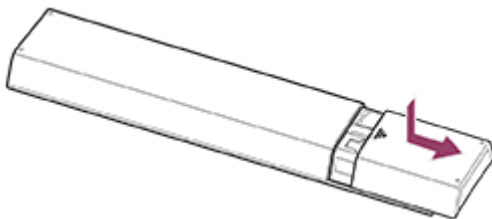

[4] Getting Started | Remote control

Available types of remote control

[Voice Remote Control](#)

[IR Remote Control](#)





[5] Getting Started



Connecting terminal

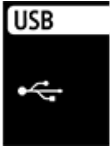



The availability of terminals and types or shapes of connectors may vary depending on your TV.

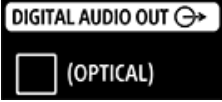

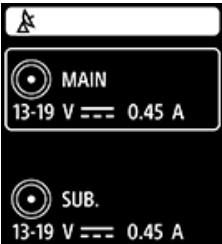

For the label and location of the terminals, refer to the Setup Guide (printed manual).

The Setup Guide can also be downloaded from the [Support Site](#).

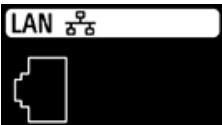
Terminal label	Description
	<p>USB</p> <p>Connects to Digital still camera/Camcorder/USB storage media.</p> <p>Note</p> <ul style="list-style-type: none"> Connecting a large USB device may interfere with other devices connected next to it. In such a case, connect it to the other USB input.
	<p>USB HDD REC</p> <p>Connects to the USB HDD device or Digital still camera/Camcorder/USB storage media.</p> <p>The USB HDD recording function is only available in limited regions/countries/TV models.</p>
	<p>BUILT-IN MIC SWITCH</p> <p>Turns on/off the built-in MIC on the TV. (only TVs with a built-in MIC)</p> <p>The availability of the terminal label may vary depending on your TV.</p>
	<p>HDMI IN</p> <p>Connects to the HDMI device. The HDMI interface can transfer the digital video and audio on a single cable. To enjoy high quality 4K contents, connect a Premium High Speed HDMI™ Cable(s) and follow the instructions displayed on the screen to set the [HDMI signal format] of the HDMI IN port. (HDCP 2.3-compatible)</p>
	<p>HDMI IN (4K 120 Hz)</p> <p>If you use an HDMI device that supports video output in 4K 100/120 Hz, connect the Ultra High Speed HDMI™ Cable, and follow the instructions displayed on the screen to set the [HDMI signal format] of the HDMI IN port. (HDCP 2.3-compatible)</p> <p>Note</p>

Terminal label	Description
	<ul style="list-style-type: none"> 4K 100 Hz support depends on your country/region.
	<p>HDMI IN (eARC/ARC)</p> <p>To connect an audio system that supports eARC (Enhanced Audio Return Channel) or ARC (Audio Return Channel), connect to the HDMI port labelled “eARC/ARC” on the TV. It is a feature that sends audio to an audio system that supports eARC/ARC through an HDMI cable. If the audio system does not support eARC/ARC, you need to connect with DIGITAL AUDIO OUT (OPTICAL).</p> <p>Hint</p> <p>There may be three tactile dots, next to the HDMI input terminal depending on your model. Use them as a guide during installation.</p>
  <p>or</p> 	<p>DIGITAL AUDIO OUT (OPTICAL)</p> <p>Connects to an audio system with optical audio input.</p> <p>When connecting an audio system not compatible with ARC using an HDMI cable, you need to connect an optical audio cable to the DIGITAL AUDIO OUT (OPTICAL) to output digital sound.</p> <p>For details, refer to Digital optical cable connection in Connecting an audio system.</p> <p>Note</p> <ul style="list-style-type: none"> The terminal vary depending on your model. Optical audio output and S-CENTER SPEAKER IN share the same terminal or have one terminal each individually (two terminals in total). For a model that requires sharing of one single terminal, use the Digital audio connector adapter that comes with the TV to apply as an optical audio output. <p>S-CENTER SPEAKER IN</p> <p>Connects the TV and an audio device with an S-CENTER OUT output/jack using a TV centre speaker mode cable. Before connecting, make sure you unplug the AC power cord (mains lead) of the TV and audio device to be connected.</p> <p>For details, refer to Using the TV as a centre speaker.</p> <p>Note</p>

Terminal label	Description
	<p>If you do not use the CENTER SPEAKER IN terminal or the S-CENTER SPEAKER IN input, you will need to perform the following steps to prevent noise from the speakers.</p> <ul style="list-style-type: none"> • Press the  (Quick Settings) button on the remote control, and disable [Acoustic Center Sync] in [Settings] — [Display & Sound] — [Audio output] — [Audio system settings]. • Optical audio output and S-CENTER SPEAKER IN share the same terminal or have one terminal each individually (two terminals in total). <p>Hint</p> <p>There may be two tactile dots, next to the S-CENTER SPEAKER IN terminal depending on your model. Use them as a guide during installation.</p>
	<p> (RF input) Connects to Cable/Antenna/External Box.</p> <p>Note</p> <ul style="list-style-type: none"> • When connecting the cable to the Cable/Antenna input, finger tighten only. Over tightening the connection can damage the TV.
	<p> (Satellite input) Connects to satellite input. Connection steps: SUB. → MAIN → Antenna.</p> <p>For SUB. jack, connect only when you are using twin tuner mode except for Single Cable Distribution EN 50494 & EN 50607 (EN 50607 is only for limited region/country/model).</p> <p>Note</p> <ul style="list-style-type: none"> • When connecting the cable to the Satellite input, finger tighten only. Over tightening the connection can damage the TV.
	<p>LAN Connect to a Router. Connect to the Internet using a LAN cable.</p>

Terminal label	Description
	<p>CAM (Conditional Access Module)</p> <p>Provides access to pay TV services. For details, refer to the instruction manual supplied with your CAM.</p> <p>Note</p> <ul style="list-style-type: none"> Do not insert the smart card directly into the TV CAM slot. It must be fitted into the Conditional Access Module provided by your authorised dealer. CAM is not supported in some countries/areas. Check with your authorised dealer. A CAM message may appear when you switch to a digital programme after using the Internet video. Do not remove the dummy card or cover (availability depends on TV model) from the TV CAM slot other than to insert a smart card fitted in CAM.
	<p>CENTER SPEAKER IN</p> <p>To use your TV speakers as the centre speaker, connect the output of your AV receiver to the CENTER SPEAKER IN on your TV.</p> <p>To use your TV speakers as the centre speaker, press the  (Quick Settings) button on the remote control, then select [Settings] — [Display & Sound] — [Audio output] — [Speakers] — [Audio system].</p> <p>Note</p> <ul style="list-style-type: none"> Before connecting cables, disconnect the AC power cord (mains lead) of both the TV and AV receiver. If you do not use the CENTER SPEAKER IN terminal or the S-CENTER SPEAKER IN input, change the following setting to prevent noise from the speakers. Press the  (Quick Settings) button on the remote control, and disable [Acoustic Center Sync] in [Settings] — [Display & Sound] — [Audio output] — [Audio system settings].

You can check the status of the TV by looking at how the LEDs light up.
The location of the LEDs varies by model.

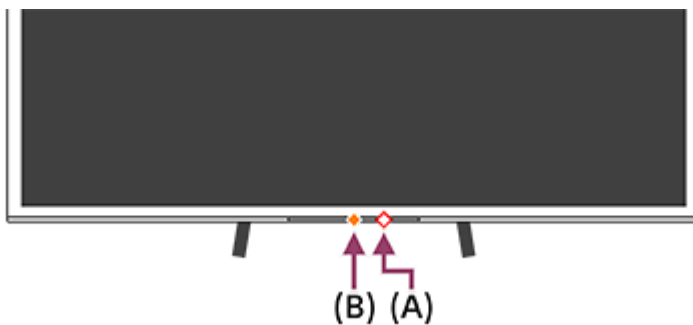
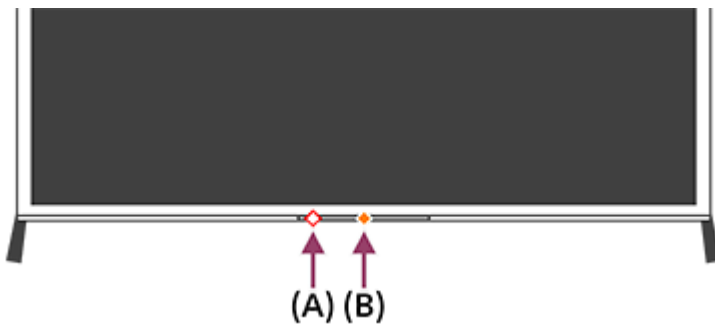

(A) Voice function LED (On the left side or centre right at the bottom of the TV. Only TVs with a built-in MIC.*)

(B) Operational response LED (In the centre at the bottom of the TV.)

* The built-in MIC on the TV may not be available depending on your region/model/language.

Voice function LED

- Turns “on” or “blinks” in white

When “Hey Google” is detected and the TV is communicating with the server.

- Turns “on” in pale yellow

When the Built-in MIC switch on the TV is off.

You need to press the Google Assistant/MIC button on the Voice Remote Control and finish activating the built-in MIC on the TV (only TVs with a built-in MIC*).

Note

- The colour of the voice function LED may vary due to specification changes.

Operational response LED

- Turns “on” in white

When the TV is turning on.

When receiving signals from the remote control.

- “Blinks” slowly in white

When updating the software using a USB storage device.

When pressing the Power button on the remote control while the TV is starting up.

- Turns “on” in amber

When the TV is set to detect “Hey Google” by the built-in MIC (only TVs with a built-in MIC*).

However, the LED may not turn on depending on the settings.

To use the built-in MIC, you may need to update the TV's software.

* The built-in MIC may not be available depending on your region/model/language.

To turn off the voice function LED and the amber operational response LED

1. Press the  (Quick Settings) button on the remote control, then select [Settings] — [System] — [LED indicator], disable [Voice detection status].

To turn off the white operational response LED

1. Press the  (Quick Settings) button on the remote control, then select [Settings] — [System] — [LED indicator], disable [Operational response].

[7] Getting Started

Home menu

The screen displayed when you press the  (HOME) button on the remote control is called the Home Menu. From the Home Menu, you can search for content and select recommended content, apps, and settings.

The items displayed on the Home Menu depends on whether a Google Account has been setup on the TV.

(Some features do not apply depending on your model/region/country. The images are for reference only. They may differ from the actual screen.)

(A) The Home Menu when a Google Account is setup on the TV

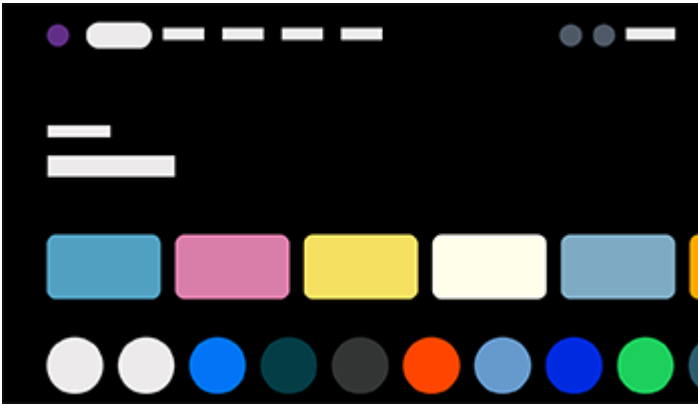

(B) The Home Menu when a Google Account is not setup on the TV



Setting up a Google Account and enjoying the TV

If you connect the TV to the Internet and setup a Google Account, you can install desired apps on the TV and enjoy Internet videos and use your voice to search for content.

Enjoying the TV without setting up a Google Account

Even if you do not setup a Google Account, you can watch TV broadcasts and/or view content from devices connected to the TV such as a Blu-ray player. If you connect the TV to the Internet, you can also use the Internet streaming services displayed on the Home Menu.

Note

- To setup a Google Account later and enjoy the TV, set up Google TV™ from the Home Menu or settings menu.
- If you delete the Google Account, the TV will return to the factory default settings.

Hint

- Depending on the TV settings, the Home screen will be displayed when the TV is turned on. If you change the following setting, you can change the screen that is displayed when the TV is turned on to the TV broadcast channel or external input such as HDMI that you were watching before turning off the TV.
 1. Press the  (Quick Settings) button on the remote control.
 2. Select [Power-on behaviour], and then select [Last used input].

The next time the TV is turned on, the TV broadcast channel or external input such as HDMI that you were watching before turning off the TV will be displayed.

Specifications may be subject to change without notice.

- For other information, see “Frequently Asked Questions” on the Sony Support Site.





[Frequently Asked Questions for Troubleshooting](#)

[8] Getting Started

Selecting inputs

To use devices (such as a Blu-ray/DVD player or USB flash drive) connected to the TV, or to watch TV after such use, you will need to switch the input.





If you edit the items and add apps, you will be able to switch to those apps in the input selection screen.

1. Press the  (Input select) button repeatedly to select the connected device. Alternatively, press the  (Input select) button, use the  (Left) /  (Right) buttons to select a connected device, and then press the  (Enter) button.

Note

- If there are no devices connected to an HDMI input, the HDMI input may not be displayed in the [Inputs].

To edit the input items

1. Press the  (Input select) button.
2. Press the  (Right) button (or  (Left) button depending on the TV's display language) and select  (Edit).

3. Select the app/input/device you want to show or hide.

4. Select [Close].

Hint

- To change the order or hide a displayed item, press the ▲ (Up) button on the remote control with that item highlighted, and [Move] and [Hide] will be displayed. If you select [Move], use ◀ (Left) / ▶ (Right) on the remote control to move the item to the desired position, and then press the -◆- (Enter) button on the remote control.
- You can switch to TV broadcasting by simply pressing the TV button on the remote control.

[9] Getting Started

Performing acoustic auto calibration

You can correct the audio to the best acoustics for your viewing environment by using the Voice Remote Control microphone to measure a test sound from the TV. (This setting may not be available depending on the model.)

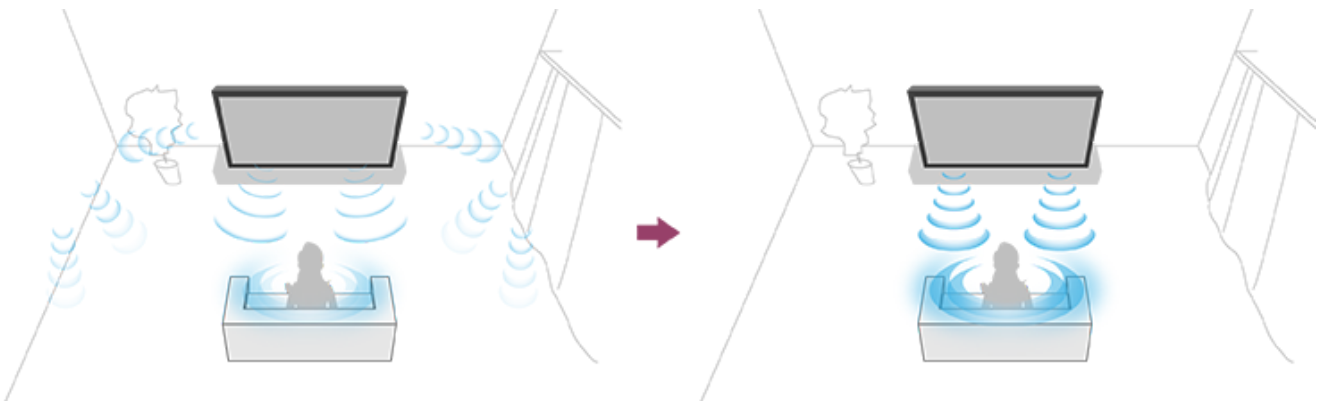

Note

- Calibration effects will vary depending on your watching environment.
- A loud test sound will be played from the TV during measurement.
- Do not block the microphone opening at the end of the Voice Remote Control during measurement.
- Do not move the Voice Remote Control during measurement. Doing so may result in incorrect measurement.
- Perform the calibration when your surroundings are quiet. Noise may result in incorrect measurement.

- Acoustic auto calibration cannot be performed if you are using a sound bar. Change the following setting.
[Settings] — [Display & Sound] — [Audio output] — [Speakers] — [TV speakers]

Models that support acoustic auto calibration have the following setting.

1. Press the  (Quick Settings) button on the Voice Remote Control, then select the following settings.
[Settings] — [Display & Sound] — [Ambient Optimisation Pro] — [Acoustic auto calibration] — [Calibration setup]
2. Measure by following the on-screen instructions.
The acoustics will be corrected automatically based on the measurement results of your watching environment.

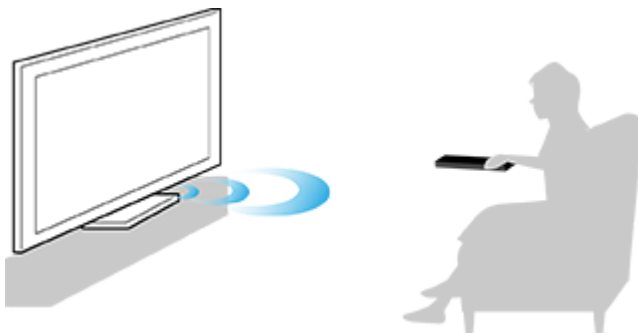

Hint

Acoustic auto calibration may fail in the following cases.

- If the Voice Remote Control is moved during measurement
- If there are sounds other than the test sound (such as noise) during measurement

[10] Getting Started

Accessibility features

This TV has accessibility features in [Accessibility] such as a text-to-speech function for on-screen text, Text magnification to make text easier to read and subtitles.

Note

- Some features do not apply depending on your model/region/country.

Press the  (Quick Settings) button on the remote control, then select [Settings] — [System] — [Accessibility] to configure the user assistive features.

[Accessibility] has a shortcut function so you can turn it on or off by pressing and holding the  (Mute) button on the remote control for 3 seconds.

Hint

- To change the shortcut function, select [Accessibility shortcut] in [Accessibility], enable [Enable accessibility shortcut], and change the function in [Shortcut service].
- To use text-to-speech with the Help Guide, view the Help Guide from the Sony support website using a computer or smartphone.
- For more information about accessibility, please visit the Sony support website. <https://www.sony.net/A11y.GoogleTV/>



<https://www.sony.net/A11y.GoogleTV/>

[11] Useful features | Searching for content/operating the TV with your voice

Using the Voice Remote Control microphone

Voice Remote Controls that support voice control have a Google Assistant/MIC button, and a built-in microphone. Ask Google Assistant to find movies, stream apps, play music, and control the TV - all with your voice. Press the Google Assistant (or MIC) button on the Voice Remote Control to get started.

1. Press and hold the Google Assistant/MIC button on your Voice Remote Control.

The microphone on the Voice Remote Control will be activated while the button is pressed, and the LED on the Voice Remote Control will light up.

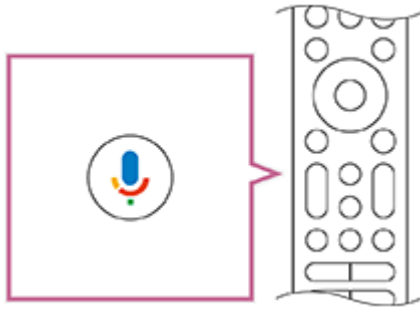

2. Speak into the microphone while pressing and holding the Google Assistant/MIC button.

Speech examples may be displayed depending on your model.



Search results are displayed when you speak into the microphone.

Note

- An Internet connection is required to use voice search.
- The type of remote control supplied with the TV, and the availability of a Voice Remote Control with a built-in microphone varies depending on your model/region/country. An optional remote control is available in some models/regions/countries.

To use the built-in MIC, you may need to update the TV's software.

- To use the microphone on the Voice Remote Control, you must add and set a Google Account to the TV.

[12] Useful features | Searching for content/operating the TV with your voice

Using the built-in MIC on the TV (only TVs with a built-in MIC)

The built-in MIC on the TV may not be available depending on your region/country/language.

To use the built-in MIC, you may need to update the TV's software.

For details about languages that support the built-in MIC on the TV feature, refer to the following Sony support website.

<https://www.sony.net/tv-hf/aep/>



<https://www.sony.net/tv-hf/aep/>

Hint

- The URL is subject to change without notice.

Do more on your TV using only your voice. Just start with “Hey Google” to:

- Control your TV and smart home devices
- Enjoy music and entertainment
- Get answers
- Plan your day and manage tasks

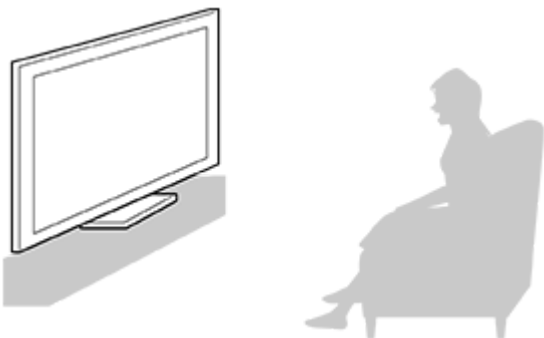

Face the TV and say, “Hey Google” to get started.

When the voice function LED blinks white, start speaking.

The location of the LED varies by model.

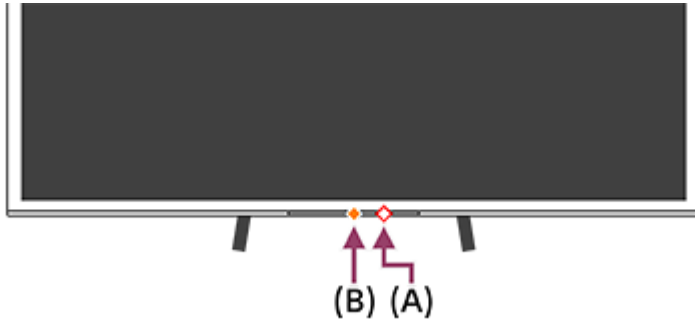
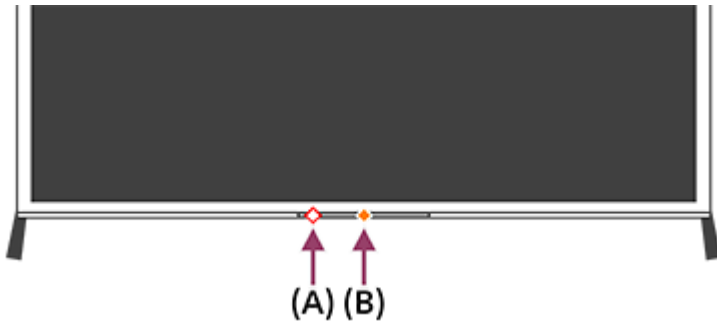

(A) The voice function LED is located at the bottom just left of centre or centre right of the TV.

(B) The LED located at the bottom centre of the TV lights up amber when the TV is set to detect "Hey Google".

To use the built-in MIC, enable the following setting.

1. Turn on the built-in MIC switch on the TV.

For the location of the built-in MIC switch on the TV, refer to the Reference Guide/Setup Guide.

Note

- An Internet connection is required to use the TV's built-in MIC.
- For full functionality of the built-in MIC on the TV, please sign in to your Google Account on the TV.
- In most cases, you can use the built-in MIC when the Built-in MIC switch is on. However, it may not be available depending on the TV settings.
- After turning on the built-in MIC switch on the TV, you need to press the Google Assistant/MIC button on the Voice Remote Control to complete the setup, depending on your model/country/region. (Only models with the built-in MIC switch)
- Power consumption will increase when the built-in MIC is enabled as it is always listening.

Hint

- The built-in MIC location is near the voice function LED.
- When the TV is set to detect "Hey Google", the Operational response LED lights up in amber even when the TV is turned off (you can also set it so it does not light up).
- The TV's built-in MIC may pick up sound from the surroundings and respond unintentionally. You can use [Built-in MIC sensitivity] to change the mic sensitivity.

Press the  (Quick Settings) button on the remote control, and select the following in order.

[Settings] — [System] — [Built-in MIC sensitivity]

[13] Useful features

Selecting the Content type based on the current content

By selecting the Content type based on what you are watching, you can enjoy richer picture and sound quality.



(A)



(B)



(C)

(A) Video/Images

(B) Game

(C) PC

1. Press the  (Quick Settings) button on the remote control, and then select the following in order.

[Settings] — [Display & Sound] — [Picture & Sound] — [Content type]

You can change the following settings.

Video/Images

Applies picture and sound quality suitable for watching video and still images.

Game

Applies picture and sound quality suitable for video games, PC games, and app game images.

PC

Applies picture and sound quality suitable for video input from a PC.

Note

- This is setting may not be available depending on the input.

[14] Useful features

Game Menu

If you press the MENU button after connecting a game console or computer, or after starting a game app, the game-specific menu is displayed at the bottom of the screen.

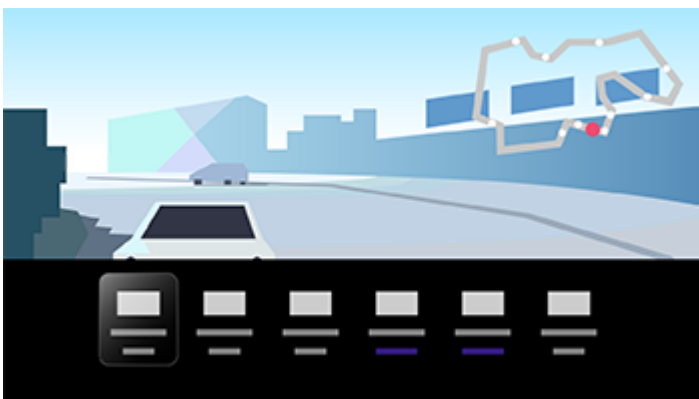

Hint

- Depending on the game console or computer you connect, or the game app you launch, the [Content type] may automatically change to [Game]. If [Game] is not selected automatically, set it manually.

Note

- The available options may vary.
- Unsupported options are greyed out (not available).

Installing apps

You can install apps to the TV, just like you do with smartphones and tablets.

Note

- You can only install apps that are compatible with TVs. They may differ from apps for smartphones/tablets.
- An Internet connection and Google Account are required to install apps.

Hint

- If you do not have a Google Account or want to create a shared account, create a new account by accessing the following website.

<https://accounts.google.com/signup>



<https://accounts.google.com/signup>

The website above may vary depending on your region/country. It is also subject to change without notice. For details, refer to the Google homepage.

- We recommend that you create a Google Account on a computer or mobile device.

1. Press the  (HOME) button, and select the Apps tab on the Home screen.
2. Select “Search for apps and games”.
3. Use the on-screen keyboard to search for app name.
4. Select an app from the search results and install it.

Hint

- If the app search does not produce the desired results, say “Google Play” while pressing the Google Assistant/MIC button on your Voice Remote Control, and try searching for the app on the Google Play Store screen.
- You can also select a category from the Apps tab in the Home Menu and select a desired app.

After downloading, the app is automatically installed and added. You can select [Open] to launch the app.

About paid apps

There are free apps and paid apps. To purchase a paid app, a prepaid Google Play gift card code or credit card information is required. You can purchase a Google Play gift card from various retailers.

To delete an app

1. Press the  (Quick Settings) button on the remote control, select [Settings] — [Apps], select an app to be deleted, and uninstall it.

[16] Useful features | Enjoying apps

Enjoying safe apps and video streaming services (Security and restrictions)

You can ensure safe use of the TV by setting installation restrictions on apps that are downloaded from unknown sources, or age restrictions on programmes and videos. (Some features do not apply depending on your model/region/country.)

You can set the following [Parental controls] features in order to:

- Restrict TV channels and use of external inputs
- Detect harmful apps
- Restrict use of apps (password lock feature)
- Restrict TV usage time

You can restrict features by setting the following.

To set age restrictions on programmes

1. Press the  (Quick Settings) button on the remote control, and then select the following in order.
[Settings] — [System] — [Parental controls] — [Channels] — [TV rating].
The options depend on your model/country/region/settings.

To restrict apps (password lock feature)

Set to restrict children from using apps such as internet browsers.

Set restrictions in [Parental controls].

If this is set, you will be required to input the PIN when starting an app.



1. Press the  (Quick Settings) button on the remote control, and select the following in order.

[Settings] — [System] — [Parental controls] — [Apps]

2. Set or input the PIN.

3. Enable [Restrict apps].

4. Select the apps that you want to restrict from the app list.

Restricted apps will change from  (Unlocked) to  (Locked). To restrict all apps, select [All apps].

To detect harmful apps

1. Press the  (Quick Settings) button on the remote control, and select the following in order.

[Settings] — [Privacy] — [Security] and change the setting.

Hint

- Other separate restrictions may be available depending on the app. For details, refer to the app's Help.

To restrict usage time of the TV

Set to restrict the time in which children use the TV.

1. Press the  (Quick Settings) button on the remote control, and select the following in order.

[Settings] — [System] — [Parental controls] — [Screen time]

2. Set or input the PIN.

3. Enable [Restrict screen time] to start restriction.

The restriction setting will be displayed under [Restrict screen time]. To change the setting, set it in [Usage time limit] or [Restricted time slot].

You can use video streaming services such as YouTube and Netflix to watch Internet content. The available services vary depending on your country and region. You can launch these services by selecting their apps in the Home Menu. If a Google Account is set on the TV, you can also select content that is displayed in the Home Menu.

Note

- An Internet connection is required to watch Internet content.
- Video streaming services such as Netflix and Amazon Prime are paid services.
- Supported video streaming services depend on the model/region/country, and some models/regions/countries do not support such services.

Hint

- Even if a Google Account is not setup on the TV, you can still see videos from, for example, YouTube displayed on the Home Menu, as long as the TV is connected to the Internet. To install new apps such as those for video streaming services, you must setup/add a Google Account on the TV.

[18] Useful features

BRAVIA Connect App

You can install the mobile app on your smartphone to operate this unit and set up a compatible audio system.



Note

- To maximise the features and performance of this TV and audio system, you may need to update the TV's software and the "Sony | BRAVIA Connect" app to the latest version.
- The availability of this function depends on your model/region/country.

[19] Useful features

Finding the Voice Remote Control (only models supplied with a buzzer built-in Voice Remote Control)

The Voice Remote Control supplied with the TV has a feature that allows you to find the Voice Remote Control by playing a sound from a built-in buzzer when you cannot find it, such as when you do not remember where you left it (for example, under a cushion or hidden under a newspaper), or when you are watching a movie in a dark room.



Use the following procedures to find the Voice Remote Control.

Using the Power button on the TV

1. Press the Power button on the TV.
A menu is displayed on the TV screen.
2. Follow the on-screen instructions and select [Find remote] on the displayed menu.
A buzzer plays from the Voice Remote Control.

Note

- The [Find remote] option, which is displayed by pressing the Power button on the TV, is only displayed when a Voice Remote Control with a built-in buzzer is paired with the TV.
- There is a limit to the distance you can search for the Voice Remote Control from your TV. The buzzer cannot be played by the Voice Remote Control in places where the signals do not reach.

[20] Useful features

Using the Camera and Microphone Unit

You can connect the Camera and Microphone Unit (CMU-BC1M) that comes with the TV (included model only) or Camera and Microphone Unit (CMU-BC1) (sold separately) to the TV to enjoy video chat or set the optimum image and sound quality for the user's viewing position.

For details on how to attach Camera and Microphone Unit (CMU-BC1) (sold separately), refer to the Setup Guide or Instruction Manual included with Camera and Microphone Unit (CMU-BC1).

Attaching and removing the Camera and Microphone Unit (CMU-BC1M) (included model only)

Attaching

Attach the supplied Camera and Microphone Unit to the Camera port on the back of the TV. You can adjust the angle and vertical position of the Camera and Microphone Unit.

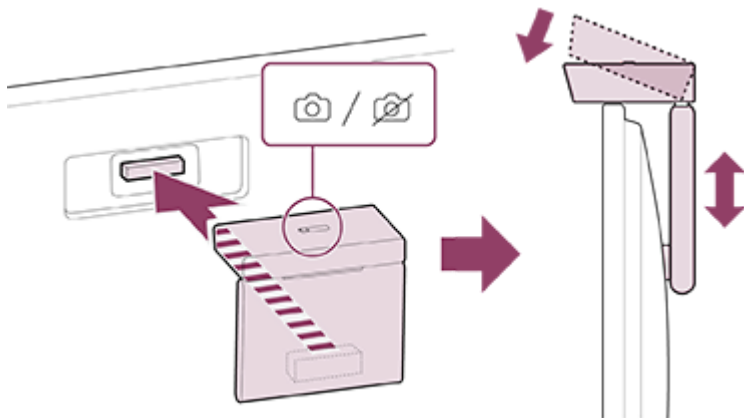

Removing

To easily remove the supplied Camera and Microphone Unit, twist it slightly as shown in the figure below.

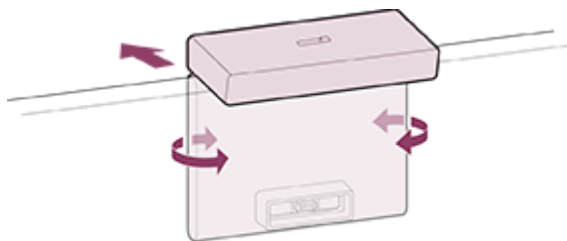

Note

- You may need to update the TV software to use the features of the Camera and Microphone Unit. Please update if a software update notification is displayed.

Setting the Camera sensing functions

Note

- Some settings cannot be set depending on the model.

Configure settings related to the sensor of the Camera and Microphone Unit.

1. Press the  (Quick Settings) button on the remote control, and select in the following order.
[Settings] — [Remotes and accessories] — [BRAVIA Cam] — the desired item

Available settings

[Auto adjust picture and sound with camera] (only for applicable models)

Optimises the picture and sound of the TV speaker according to the viewing position and environment detected by the camera.

- **Adjust according to viewing environment**

- [Adjust for reflection]**

- Optimises the picture's brightness based on ambient light conditions to reduce glare and improve visibility.

- **Adjust according to viewing position**

- [Brightness]**

- Automatically adjusts the brightness according to the viewing distance to make colours more visible.

- [Voice emphasis]**

- Automatically adjusts the volume according to the viewing distance. If you are far from the TV, the sound is made more audible.

- [Sound balance]**

- Adjusts the balance so it sounds as if you are viewing from the front of the TV even if you are actually not.

[Auto adjust picture and sound according to viewing position] (only for applicable models)

- **[Brightness]**

- Automatically adjusts the brightness according to the viewing distance to make colours more visible.

- **[Voice emphasis]**

Automatically adjusts the volume according to the viewing distance. If you are far from the TV, the sound is made more audible.

- **[Sound balance]**

Adjusts the balance so it sounds as if you are viewing from the front of the TV even if you are actually not.

[Gesture Control]

Allows use of gestures in front of the TV to turn the TV off, adjust the volume, change the channel, or play back content.

[Proximity Alert]

Notifies you if the TV viewing distance is too close.

You must input your PIN to enable this feature. When enabled, it will be set at 1 m (3 ft.) (default). You can select [Set distance] to set any distance.

[Auto power saving mode]

Automatically switches to power saving, such as reduced brightness, when a user is not detected in front of the TV for a certain period of time.

Hint

[BRAVIA Cam] in the Camera and Microphone Unit has features available in addition to Camera sensing functions. Configure them as necessary.

- With Camera sensing functions, camera images are not sent to the network, you can erase the data collected by the Camera and Microphone Unit and reset Camera sensing functions.

[Settings] — [Remotes and accessories] — [BRAVIA Cam] — [Clear data]

- To turn off the Camera and Microphone Unit LED, disable the following setting.
[Settings] — [Remotes and accessories] — [BRAVIA Cam] — [Camera activity LED]

The LED will always turn on during video chat or while updating the Camera and Microphone Unit.

- Updating the software of the Camera and Microphone Unit may be required. To check for software updates, select the following in order.

[Settings] — [Remotes and accessories] — [BRAVIA Cam] — [Software update]

Available features

Searching for content/operating the TV with your voice

[Using the Voice Remote Control microphone](#)

[Using the built-in MIC on the TV \(only TVs with a built-in MIC\)](#)

Selecting Content type

[Selecting the Content type based on the current content](#)

Enjoying game features

[Game Menu](#)

Enjoying apps

[Installing apps](#)

[Enjoying safe apps and video streaming services \(Security and restrictions\)](#)

[Viewing Internet content](#)

BRAVIA Connect App

[BRAVIA Connect App](#)

Finding the Voice Remote Control

[Finding the Voice Remote Control \(only models supplied with a buzzer built-in Voice Remote Control\)](#)

Camera and Microphone Unit

[Using the Camera and Microphone Unit](#)

[22] Watching TV | Watching TV programmes

Watching Live TV

1. Press the TV button on the remote control to display TV channel or switch to input.
2. Press the CH +/- button and select the preferred channel.

[23] Watching TV | Watching TV programmes

Using the programme guide



You can quickly find your preferred programmes.



The functions available depend on your region/country/settings.

1. Press the  (Guide) button to display the digital programme guide.
2. Select a programme to watch.

Using the [Favourites] feature

To add a channel to [Favourites], select  (Favourites) in the programme guide. If you select  (Favourites) in the [Guide] column that is displayed by repeatedly pressing the  (Left) button on the remote control, the channels registered in [Favourites] and your [Most watched] will be displayed in the programme guide.

Filtering the channels displayed in the programme guide

You can set conditions to filter the channels displayed in the programme guide. While the programme guide is displayed, repeatedly press the  (Left) button on the remote control to display the filter and set the conditions. (This function is available only in limited region/country/settings.)

Hint

- (TV box control compatible models only) If you perform the [TV box control setup] setting in [TV box setup] under [External inputs], you can display the programme guide of the TV box.

- You can change the channels listed in the programme guide by using [Guide], which is displayed by pressing the ◀ (Left) button on the remote control several times.
- With [Duration], you can change the time axis displayed in the programme guide from two hours to four hours. You can set [Duration] from [Settings] in the [Guide] column on the left side of the programme guide.

[24] Watching TV | Watching TV programmes

Receiving digital broadcasts

1. Press the ⚙ (Quick Settings) button on the remote control, then select [Settings] — [Channels & Inputs] — [Channels] — [Channel setup] — [Auto tuning].
2. Follow the on-screen instructions to tune in all available digital channels and store them in the TV.

To change the tuning range

Press the ⚙ (Quick Settings) button on the remote control, then select [Settings] — [Channels & Inputs] — [Channels] — [Channel setup] — [Advanced settings] — [Tuning range] — [Normal] or [Extended].

[Normal]

Searches for available channels within your region/country.

[Extended]

Searches for available channels regardless of region/country.

Hint

- You can retune the TV by selecting [Auto tuning] and following the on-screen instructions after moving to a new residence, changing service providers, or to search for newly launched channels.

[25] Watching TV | Watching TV programmes

Receiving satellite broadcasts

If you have a satellite dish installed, you can view satellite broadcasts by configuring the tuner settings.

1. Press the  (Quick Settings) button on the remote control, then select [Settings] — [Channels & Inputs] — [Channels] — [Channel setup] — [Auto tuning] — [General satellite] — [Set up] for subscribed satellite broadcasts.
2. Follow the on-screen instructions.

[26] Watching TV | Watching TV programmes

Sorting or editing the channels

You can sort the channel display according to your preferred order.

1. Press the  (Quick Settings) button on the remote control, then select [Settings] — [Channels & Inputs] — [Channels] — [Channel list edit].
If multiple items are displayed, select the one you want to edit.
2. Choose the channel you want to move to a new position.
You can select to [Insert] or [Swap] the selected channel. To change it, select [Sorting type].
3. Choose the new position where you want to move the selected channel.
4. Select [Done] to apply the changes.

Note

- Available options may vary depending on your region/country.

Editing the channel list with a smartphone

You can edit the channel list with your smartphone.

1. Press the  (Quick Settings) button on the remote control, then select [Settings] — [Channels & Inputs] — [Channels] — [Channel list edit from mobile device].
2. Follow the on-screen instructions.

[27] Watching TV | Watching TV programmes

Using the TV menu

Press the TV button while watching a TV broadcast to display the [TV menu]. A channel list is displayed in [TV menu] and you can easily select programmes on other channels while watching TV.





Note

- The displayed screen and menus may vary depending on what you are watching and your model/country/region.

1. Press the TV button while watching a TV broadcast.
The TV menu is displayed at the bottom of the screen.
2. Move the focus left or right and select the programme you want to watch.

Hint

- You can use the following features if you press  (Up) on the remote control while [TV menu] is displayed.

 (Guide): Display the programme guide
Change the displayed channel list

- You can use the TV button on the remote control to display the channels from the TV box.

Press the  (Quick Settings) button on the remote control, then select [Settings] — [Channels & Inputs] — [TV button shortcut].

Then, select the input that is connected to the TV box.

- If you configured a TV box in the initial setup, you can press the TV button to display the channel list of the TV box.

TV box control compatible models have [TV box setup] in [Settings] — [Channels & Inputs] — [External inputs].

[28] Watching TV | Watching TV programmes

Using interactive broadcast TV services

To display text information

You can view text and text-based graphical information, including national news, weather information, and TV schedules. You can browse for information that interests you, and then select what information you want to display by entering a number.

1. Press the MENU button to display the [Control menu], and select [Colour buttons/Data broadcasting] — [Text] from the menu to display text information.

About the Digital Text Information Service

The digital text service offers rich content with smooth graphics and images. Various features are available, such as page links and easy-to-use navigation. The service is supported by numerous broadcasters. (The availability of this feature depends on your model/region/country.)

About the Digital Interactive Application Service

The interactive application service offers high-quality digital text and graphics, along with advanced options. The service is supported by broadcasters. (The availability of this feature depends on your model/region/country.)

Note

- The interactive service is only available if provided by the broadcaster.
- Available functions and screen content varies depending on the broadcaster.
- If subtitles are selected and you launch a digital text application, subtitles may, under certain circumstances, stop being displayed. When you exit the digital text application, subtitle display will resume automatically.

Using the Timeshift feature

This function is available only in limited regions/countries/TV models.

To use this function, you may need to update the TV's software.

You can use the [Timeshift] feature to pause a broadcast content while watching them. You can watch the broadcast content from the paused scene later.

Connect and register a USB HDD device to your TV to enjoy this feature. See [Registering a USB HDD device](#).

1. While a broadcast content is being played back, press the MENU button on the remote control. Select [Timeshift start] from the menu displayed at the bottom of the screen. Content playback is paused.

To re-start the playback

1. Press the ► (Play) button on the remote control, or follow the on-screen instruction. The playback will re-start in a paused state.

Note

- [Timeshift] does not work immediately. Wait for a few seconds.
- [Timeshift] is not supported during recording other content.

Hint

- You can stop [Timeshift] by pressing ↶ (BACK) button on the remote control or by launching other applications.
- You can also start [Timeshift] by pressing ■■ (Pause) button on the remote control while a broadcast content is being played back.

Useful features when watching TV

Timers

Use a timer to turn the TV on and off.

You can turn off the TV at a preset time (timer function) or play a tone at a preset time (alarm function).

For details, refer to [Timers & Clock](#).



Parental lock

You can set various restrictions, such as app usage, TV usage time, and age restrictions.

For details, refer to [Parental controls] under [System](#).



Picture quality/sound quality adjustment

Adjust the picture quality and sound quality according to your preferences.

For details, refer to [Display & Sound](#).

Subtitles

For details, refer to [Display subtitles](#).

Change the settings

Press the MENU button on your remote control.

You can change the settings such as [View settings], [Wide mode], [Audio], etc.

Note

- The menus displayed in the TV settings vary depending on your model, region, or country, and some options may not be displayed or available based on the TV's settings.

Adjusting the picture quality

You can configure various settings related to the TV display such as colour and brightness for picture quality, or screen size.

Note

- The actual display may vary or some settings may not be available depending on your model/country/region and the content you are watching.

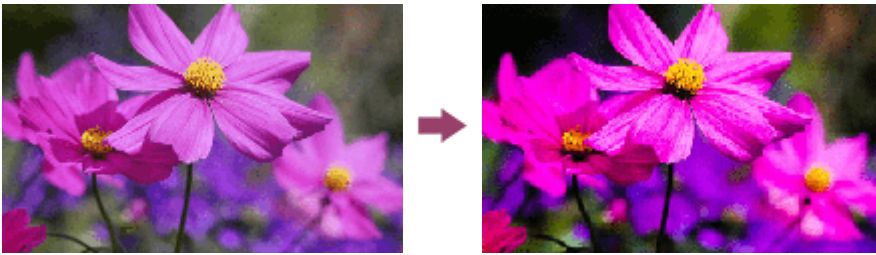

Press the  (Quick Settings) button on the remote control, then select [Settings] — [Display & Sound] — [Picture & Sound] — the desired option.

You can change the following settings.

You can set the picture quality according to the [Content type].

For details, refer to [Selecting the Content type based on the current content](#).

Picture

Adjust the picture settings such as Brightness, Colour, and Hue.

Basic

You can set the following.

- **Picture mode**
Change the picture quality according to the content you are watching such as movies.
- **Reset picture settings for *****
Reset the picture settings for the current picture mode to the factory default.
- ***** calibrated mode**
Adjusts the picture to a quality close to that intended by the content creator when watching supported video streaming content and supported apps.

Brightness

Adjust the backlight to display the brightest whites and deepest blacks.

Colour

Adjust the colour saturation level and Hue.

- **Advanced colour adjustment (***)**

You can set the following.

- Adv. colour temperature: Basic**

- Finely adjust the colour temperature for each colour.

- Adv. colour temperature: Multi point (***)p**

- Professional calibrator settings. When adjusting, we recommend using a colour analyser.

- Per colour adjustment**

- Adjust Hue, Saturation, and Lightness for each colour.

Clarity

Adjust the picture clarity and reduce roughness.

Motion

You can set the following.

- **Motionflow**

- Refines moving images. Increases the number of image frames to display videos smoothly. If you select [Custom], you can adjust [Smoothness (Camera)], [Smoothness (Film)] and [Clearness].

- **Film mode**

- Optimises picture quality based on video content, such as movies and computer graphics. Smoothly reproduces the motion of filmed images (images recorded at 24 frames per second) such as movies.

- **Motion blur reduction**

- Adjustment is similar to that of [Clearness] in [Motionflow].

Note

When [Content type] is set to [Game], [Motion blur reduction] is enabled, and [Motionflow] and [Film mode] are disabled.

Video signal

You can set the following.

- **Colour space**

- Change the colour reproduction range.

- **HDR mode**

- Picture that is suitable for a High Dynamic Range signal.

Hint

- Detailed information on input signals for broadcasts and external inputs can be displayed.

Press the MENU button on the remote control while a broadcast or external input video is displayed, and select [Detailed signal info] from the menu that is displayed at the bottom of the screen.

Detailed information on the input signal (such as resolution, scanning method, and frequency) is displayed. The detailed information that is displayed depends on the input signal.

To close the display, press the ↶(BACK) button on the remote control.

Note

- Detailed information is only available for broadcasts and external inputs.
- Detailed information may not be displayed based on the settings.

[32] Watching TV | Adjusting the picture/screen/sound quality to your preferences

Adjusting the screen

You can adjust the horizontal to vertical ratio of the screen and the display area.

1. While a broadcast or HDMI input image is displayed, press the MENU button on the remote control.
2. Set from the menu displayed at the bottom of the screen.

You can change the following main settings.

Wide mode

You can change the screen size to fit the video.

You can watch in the optimal screen mode.

Display area

You can change the display area.

Hint

- When 4096 × 2160p is input and [Wide mode] is set to [Vertical fit], the resolution is displayed as 3840 × 2160p. To display 4096 × 2160p, set [Wide mode] setting to [Horizontal fit], [Auto] or [Full].

Adjusting the sound quality

You can configure various settings related to the TV's sound such as sound quality and sound mode.

Note

- The actual display may vary or some settings may not be available depending on your model/country/region, TV settings, and the connected device.

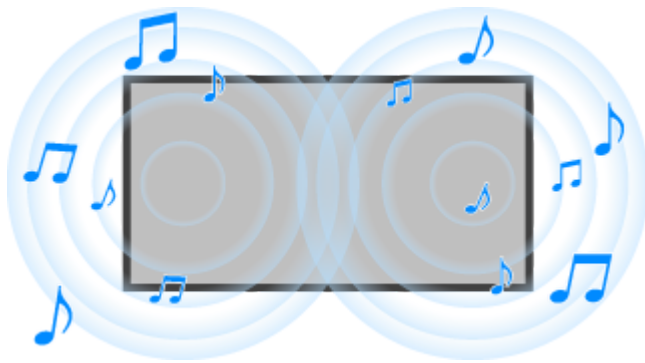

Press the  (Quick Settings) button on the remote control, then select [Settings] — [Display & Sound] — [Picture & Sound] — the desired option.

You can change the following settings.

Sound (***)

Adjust audio from the TV speakers, audio output to an audio system connected via HDMI or optical audio output, or audio output to wired headphones or Bluetooth-connected devices.

Sound settings

You can change the following settings.

- **Surround**
Virtually reproduce realistic surround sound.
- **Surround effect**
Adjust the surround sound effect.
- **Voice Zoom**
Emphasise voice.
Displayed when [Post-processing] is set to [Standard].
When [Voice Zoom] is enabled, if sound is changed to output from the TV speakers and Bluetooth headphones or speakers simultaneously, [Voice Zoom]

will be disabled automatically. If the simultaneous sound output stops, the [Voice Zoom] will be enabled again.

- **Dialogue enhancer**

Enhance voices when [Post-processing] is set to [Dolby Audio processing].

- **Equaliser**

Adjust sound based on different frequencies.

- **Reset**

Return all sound settings to factory default.

- **3D surround (***)**

Enables or disables 3D surround (stereophonic sound).

Volume settings

You can change the following settings.

- **Balance**

Adjust the speaker balance.

For details, refer to [Balance](#).

- **Beam tweeter level**

Adjusts the volume of sound reflected from the ceiling.

- **Advanced auto volume**

Keeps the volume level consistent for all programmes and inputs.

For details, refer to [Advanced auto volume](#).

- **Dolby AC-4 Dialogue level**

Adjusts dynamic range of Dolby AC 4 signal.

Dynamic range settings

You can change the following settings.

- **Dynamic range**

Compensates for audio level difference between input sources (for Dolby Digital audio and HE AAC audio).

Displayed only when [Inputs] is HDMI or during [Media Player] playback.

- **DTS Dynamic range**

Adjusts dynamic range of DTS signal.

General

You can change the following settings.

- **Post-processing**

Select [Standard] (Sony), audio processed by Dolby technology or audio processed by DTS technology.

Adjust only for ***

When [On], the picture and sound quality is adjusted for the currently selected video input or app. When [Off], the picture and sound quality is adjusted for all inputs and apps.

Prioritise HDMI signal information

Automatically sets the content type based on the Content Type information in the HDMI signal. If it does not set automatically, set this to [Off].

Audio output

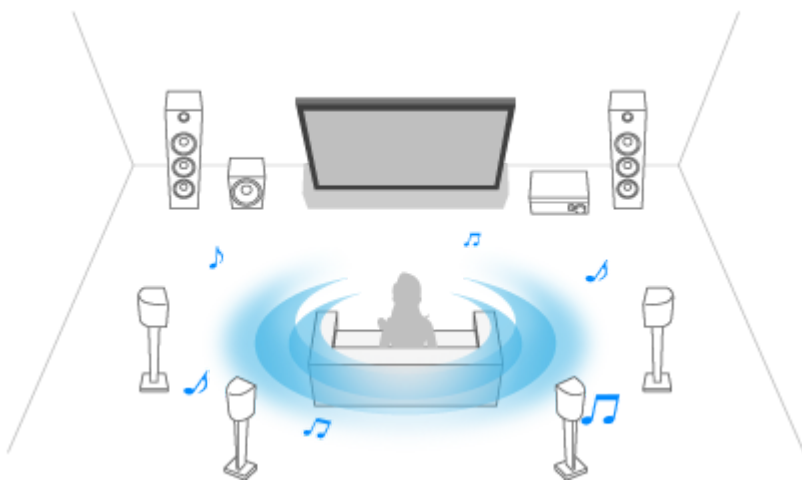

Configure to output sound from headphones or an audio system instead of the TV speakers.

Press the  (Quick Settings) button on the remote control, then select the following settings.

[Settings] — [Display & Sound] — [Audio output] — the desired setting.

You can configure settings such as those below.

- **Speakers**

Select TV or external speakers.

- **Bluetooth device**

Select Bluetooth device connected to the TV to output audio.

- **Audio system settings**

Sets output to devices connected via HDMI.

Acoustic Center Sync

Use the TV speakers as the centre speaker of the home theatre system.

For details, refer to [Using the TV as a centre speaker](#).

Audio system prioritisation

When enabled, this automatically switches the audio output to a BRAVIA Sync-compatible audio system when the TV is turned on.

A/V sync

Adjusts output timing to reduce delay between video and audio when using certain audio systems connected via HDMI.

Digital audio output

Configure the output method when outputting digital audio. This setting is available only when [Speakers] is set to [Audio system].

Hint

There is less deterioration and noise from signal transmission, and the sound quality is superior compared to analogue connections.

eARC setting

If [Auto] is selected, high quality audio is output when an eARC supported device is connected to an HDMI port labelled "eARC/ARC".

eARC is an enhanced version of ARC and stands for Enhanced Audio Return Channel. By connecting an eARC supported device, you can enjoy uncompressed, high-quality audio formats and newer surround audio formats in addition to the audio formats supported by ARC. For supported audio formats, refer to [Audio formats](#).

To connect the TV and an eARC supported device, use an eARC-supporting HDMI cable^{*}. To connect an eARC supported device, refer to [Connecting an audio system](#).

^{*} An authorised Premium High Speed HDMI™ Cable(s) is recommended.

- **Bluetooth device settings**

Settings for devices connected via Bluetooth.

A/V sync

When using a Bluetooth audio device (A2DP supported), the output timing is adjusted to minimise the delay between video and audio.

Bluetooth settings

Enables/disables Bluetooth.

For details, refer to [Remotes and accessories](#).

3D surround device settings

Virtually reproduce realistic surround sound.

For details, refer to [Remotes and accessories](#).

- **Optical digital audio output settings**

Enables optical digital audio output, and configures the output.

Optical digital audio output

Outputs the audio signal to the device connected to the optical digital audio output terminal.

Digital audio output

Configure the output method when outputting digital audio. This setting is available only when [Speakers] is set to [Audio system].

Hint

There is less deterioration and noise from signal transmission, and the sound quality is superior compared to analogue connections.

Optical digital audio output volume

Adjusts the digital audio output level. Only valid for the PCM sound source. The volume levels between the PCM sound source and the compressed sound source will differ.

[34] Watching TV | Adjusting the picture/screen/sound quality to your preferences

Advanced auto volume

If [Speakers] is set to [TV speakers], the volume can be automatically adjusted to a certain level according to changes in the volume level of broadcasts and input signals.

Reducing the volume difference that occurs when switching channels or inputs allows you to watch at a constant volume level. To enable this feature, press the  (Quick Settings) button on the remote control, then select the following settings. [Settings] — [Display & Sound] — [Picture & Sound] — [Sound (***)] — [Advanced auto volume]

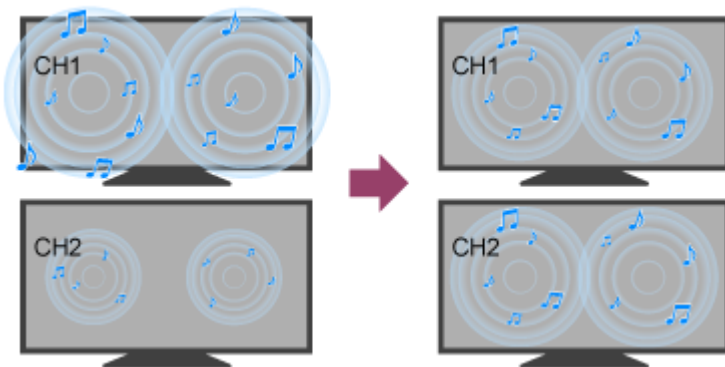

Note

- The effect varies depending on your model/country/region, settings, broadcast, and input signal.

[35] Watching TV | Adjusting the picture/screen/sound quality to your preferences

Balance

If [Speakers] is set to [TV speakers], the balance of the left and right sound can be adjusted.

Due to the distance to walls and windows and the reflection of sound, you may hear the left and right sound become unbalanced. To adjust the sound balance, press the  (Quick Settings) button on the remote control, then select the following settings.

[Settings] — [Display & Sound] — [Picture & Sound] — [Sound (***)] — [Balance]

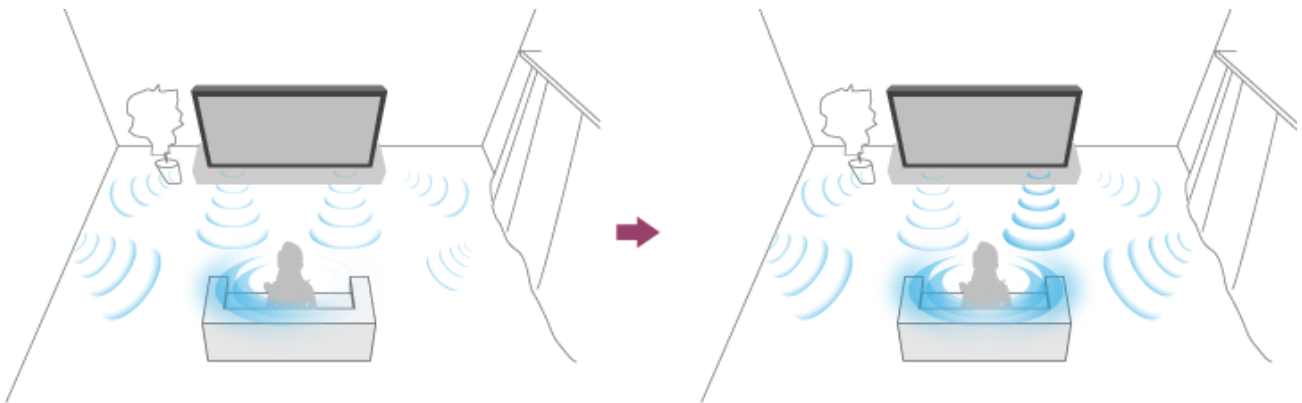

Note

- The effect varies depending on your model/country/region, settings, and installation environment.

[36] Watching TV | Adjusting the picture/screen/sound quality to your preferences

Adjusting the picture/sound quality automatically

The picture and sound quality can be automatically adjusted according to the TV's installation environment.

Note

- Depending on the model, what you are watching, the TV settings, and connected devices, the actual screen may differ or some settings may not be available.

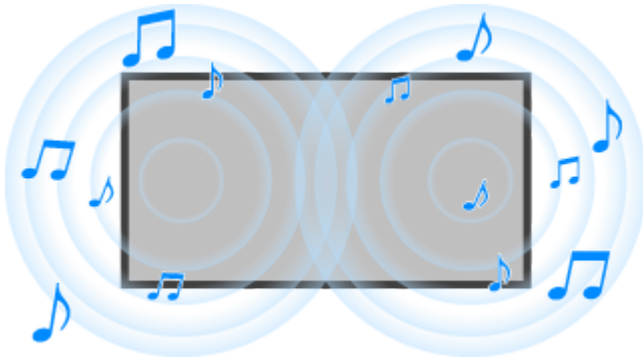
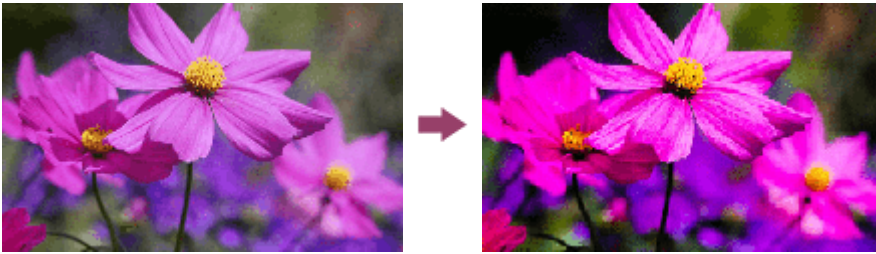

Press the  (Quick Settings) button on the remote control, then select the following settings.

[Settings] — [Display & Sound] — [Ambient Optimisation Pro]

You can change the following settings.

Auto adjust according to sensors

You can set the following.

- **Auto adjust according to ambient light**

Optimises picture brightness or colour* automatically by sensing the luminance of ambient light.

* The colour adjustment is only available for compatible models.

- **Auto adjust according to viewing position (only for applicable models)**

Optimises picture and sound according to the viewing position detected by the camera.

- **Auto adjust with camera (only for applicable models)**

Optimises the picture quality and TV speaker sound based on the viewing position and environment detected by the camera for an enhanced experience.

Adjust for reflection

Optimises the picture's brightness based on ambient light conditions to reduce glare and improve visibility.

Auto adjust according to viewing position

Optimises picture and sound according to the viewing position detected by the camera.

Auto adjust according to installation environment

You can set the following.

- **Acoustic auto calibration**

Adjust audio output based on your viewing environment.

For details, refer to [Performing acoustic auto calibration](#).

[37] Watching TV

Display subtitles

You can press the MENU button on the remote control to enable subtitles.

[38] Recording TV Programmes | Recording to a USB HDD device

Registering a USB HDD device

This function is available only in limited regions/countries/TV models.

To use this function, you may need to update the TV's software.

USB HDD recording models have [Recording device setup] in [Settings] — [Channels & Inputs].

Connect and register a USB HDD device to your TV to record digital broadcasts.

Connect the USB HDD device to the TV's USB port labelled "HDD REC" (if there is a blue USB port, that port supports HDD recording).

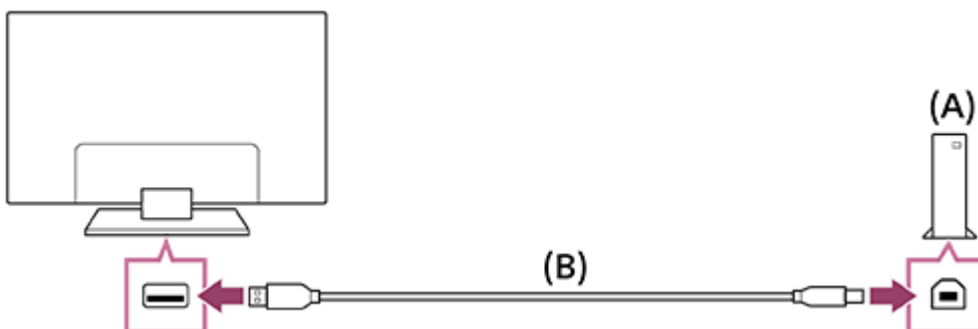

(A) USB HDD device

(B) USB cable (not supplied)

1. Connect a USB HDD device to the USB port (blue) labelled “HDD REC” on your TV.
2. Turn the USB HDD device on.
3. Wait until the screen [USB drive connected] is displayed.
If the message does not appear you can manually register the USB HDD device from the Settings menu.
4. Select [Register for recording].
5. Follow the on-screen instructions to register the USB HDD device.

Note

- If the message “Can't detect a USB HDD for recording” is displayed during registration in step 4, follow the instructions in the message and check that the USB HDD device for recording is connected to the Super Speed USB port (blue).
If the USB HDD device for recording is not recognised even after you have checked the connection, you must register the USB HDD device again because it may have already been registered as a device for purposes other than recording.

To register a USB HDD device manually

1. Press the  (Quick Settings) button on the remote control, and select the following.
[Settings] — [Channels & Inputs] — [Recording device setup] — [HDD registration].

[39] Recording TV Programmes | Recording to a USB HDD device

Timer recording

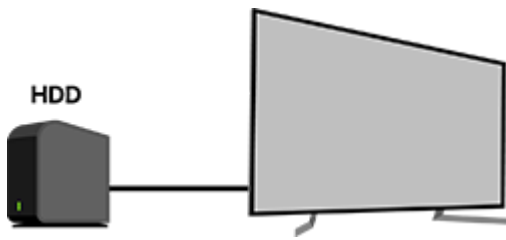

This function is only available in limited regions/countries/TV models.
To use this function, you may need to update the TV's software.

USB HDD recording models have [Recording device setup] in [Settings] — [Channels & Inputs].





1. Press the  (Guide) button.
2. Select the desired programme in the programme guide, then select [Timer REC].
3. Select [Set timer].

To manually set the timer by specifying date, time and channel

1. Press the  (Input select) button and select [Recorded Title List] (Recorded Title List). If [Recorded Title List] does not exist, select  [Edit] and add [Recorded Title List].
2. Select [Timer list/Timer settings] — [Set timer] — [Set timer manually].
3. Configure the timer setting.
4. Select [Set timer].

To check, modify or delete timer settings

Checking, modifying, or deleting timer settings is performed in [Recording timer list].

1. Press the  (Input select) button and select [Recorded Title List] (Recorded Title List). If [Recorded Title List] does not exist, select  [Edit] and add [Recorded Title List].
2. Select [Timer list/Timer settings] — [Recording timer list], then change the settings.

Hint

- Up to 130 timer settings can be created.
- If the recording fails, the reason will be listed in [Recording error list]. Select [Recording error list] in [Timer list/Timer settings].

Note

- Timer recording will not work when the AC power cord (mains lead) is unplugged.

[40] Recording TV Programmes | Recording to a USB HDD device

Information about using a USB HDD device for recording

This function is only available in limited regions/countries/TV models.

To use this function, you may need to update the TV's software.

USB HDD recording models have [Recording device setup] in [Settings] — [Channels & Inputs].

- The USB HDD device must be used exclusively for recording. Use a separate USB HDD device for viewing photos and videos.
- Only USB HDDs larger than 32 GB are supported.
- Connection of a USB HDD device via a USB hub is not supported. Connect the device directly to the TV.
- Any data stored in the USB HDD device will be erased when it is formatted during the registration process. The USB HDD device cannot be used with a PC once it has been registered to the TV. To enable use of the USB HDD device on a PC, format it on the PC. (Note that any data in the USB HDD device will be erased.)
- Only this TV will be able to play the data recorded on the USB HDD that has been registered to this TV.
- Recording is supported only for digital TV and radio broadcasts. Recording of data broadcasts is not supported.
- Scrambled/encrypted signals cannot be recorded.
- Recording cannot be performed in the following cases:
 - The TV cannot recognise the registered USB HDD device.
 - More than 3,000 programmes are recorded on the USB HDD device.
 - The USB HDD device is full.
- Automatic selection of the programme may not be possible while it is being recorded.
- Recording a programme is not possible unless its recording has been authorised.

- If using a Conditional Access Module (CAM), avoid using its parental rating protection, which may not work during recording. As an alternative, use programme block or the TV's own parental rating if it is supported by the broadcaster.
- In Norway, some programmes cannot be recorded due to legal restrictions.
- If the TV is subjected to impact during USB HDD recording, noise may occur in the recorded content.
- In no event shall Sony be liable for recording failure or any damage or loss of recorded content caused or associated with the TV's malfunction, signal interference, or any other problem.

[41] Recording TV Programmes



Watching/deleting recorded content

This function is only available in limited regions/countries/TV models.





To use this function, you may need to update the TV's software.

USB HDD recording models have [Recording device setup] in [Settings] — [Channels & Inputs].

To watch recorded content

1. Press the  (Input select) button and select [Recorded Title List] (Recorded Title List). If [Recorded Title List] does not exist, select  [Edit] and add [Recorded Title List], then select the content to be watched.

To delete recorded content



1. Press the  (Input select) button and select [Recorded Title List] (Recorded Title List). If [Recorded Title List] does not exist, select  [Edit] and add [Recorded Title List].
2. Select the  (Delete icon) to the right of the programme you want to delete. To delete multiple programmes, select  (Delete multiple icon) to the right of all the programmes you want to delete, and then select  (Delete icon).

For information about the meaning of the symbols in the recorded title list, see [Understanding the symbols displayed in the recorded title list](#).

[42] Recording TV Programmes

Understanding the symbols displayed in the recorded title list

This function is only available in limited regions/countries/TV models.
To use this function, you may need to update the TV's software.

-  : Unviewed recording
 -  : Protected recording
 -  : Currently recording
-

[43] Using the TV with Other Devices | USB devices

Playing content stored on a USB device

To record programmes to a USB storage device, see [Timer recording](#).
To watch recorded programmes, see [Watching/deleting recorded content](#).

Connecting a USB device

Connect a USB storage device to the USB port of the TV to enjoy photo, music, and video files stored on the device.

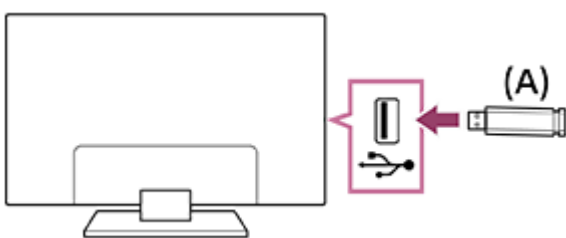

(A) USB storage device

Enjoy photos/music/movies stored on a USB device

You can enjoy photos/music/movies stored on a USB device on the TV screen.

1. If the USB device connected to the TV has a power switch, turn it on.
2. Press the  (HOME) button, and select [Apps] from the Home menu, then select [Media Player].
3. Select the USB device name.

4. Select the folder, and select the file to play.

To check the supported file formats

- [Photos](#)
- [Music](#)
- [Videos](#)
- [Audio sampling rates \(for videos\)](#)
- [External subtitles](#)

Note

- Some photo images or folders take time to display depending on the image dimension, file size, and number of files in a folder.
- Displaying the USB device may take some time because the TV accesses the USB device every time the USB device is connected.
- All USB ports on the TV support Hi-Speed USB. The blue USB port supports SuperSpeed (USB 3.2 Gen 1, USB 3.1 Gen 1 or USB 3.0). USB hubs are not supported.
- While accessing the USB device, do not turn off the TV or USB device, do not disconnect the USB cable, and do not remove or insert recording media. Otherwise, data stored on the USB device may be corrupted.
- Depending on the file, playback may not be possible, even when using the supported formats.
- To enjoy photos, you may need to update the TV's software.

Hint

- For other information, see “Frequently Asked Questions” on the Sony Support Site.
[Frequently Asked Questions for Troubleshooting](#)

[44] Using the TV with Other Devices | USB devices

Information about USB devices used for storing photos and music

- The USB ports on the TV support FAT16, FAT32, exFAT, and NTFS file systems.
- When connecting a Sony digital still camera to the TV with a USB cable, USB connection settings on your camera need to be set to “Auto” or “Mass Storage”

mode.

- If your digital still camera does not work with your TV, try the following:

Set the USB connection settings on your camera to “Mass Storage”.

Copy the files from the camera to a USB flash drive, then connect the drive to the TV.

- Some photos and movies may be magnified, resulting in low picture quality. Depending on the size and aspect ratio, images may not be displayed in full screen.
- It may take a while to display a photo, depending on the file and/or settings.
- In no event shall Sony be liable for recording failure or any damage or loss of recorded contents caused or associated with the TV’s malfunction, the USB device’s malfunction, or any other problem.

[45] Using the TV with Other Devices | TV box, Blu-ray and DVD players

Connecting a TV box, Blu-ray or DVD player

Connect a TV box, Blu-ray/DVD player to the TV.

Use a connection method below based on the terminals available on your TV.

Note

- The available terminals depend on your model/region/country.

HDMI connection

For optimum picture quality, we recommend connecting your player to the TV using an HDMI cable. If your Blu-ray/DVD player has an HDMI jack (socket), connect it using an HDMI cable.

To connect an audio system or sound bar at the same time, refer to HDMI connection (eARC supported) in [Connecting an audio system](#).

To adjust the video and audio output timing, refer to [Adjusting the AV sync setting](#).

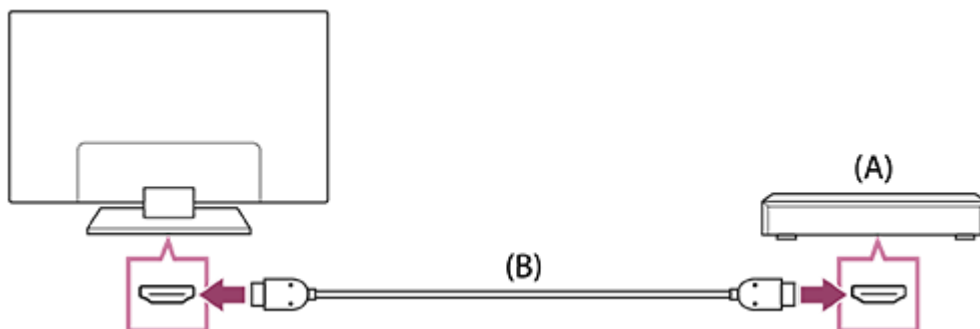

(A) Blu-ray/DVD player (same as connecting a TV box)

(B) HDMI cable (not supplied)*

* Be sure to use an authorised Premium High Speed HDMI™ Cable(s) bearing the HDMI logo.

[46] Using the TV with Other Devices | TV box, Blu-ray and DVD players

Watching Blu-ray and DVD discs

You can watch content from Blu-ray/DVD discs or other content supported by your player on the TV.

1. Turn on the connected Blu-ray/DVD player.
2. Press the  (Input select) button repeatedly to select the connected Blu-ray/DVD player.
3. Start playback on the connected Blu-ray/DVD player.

Hint

- If you connect a BRAVIA Sync-compatible device with an HDMI connection, you can operate it by simply using the TV's remote control. Also, if you press MENU on the remote control while watching content from the HDMI input, select [*** controls], you can operate the BRAVIA Sync-connected device from the TV screen.

[47] Using the TV with Other Devices | TV box, Blu-ray and DVD players

How to control the TV box using the TV remote control

TV box control compatible models have [TV box setup] in [Settings] — [Channels & Inputs] — [External inputs].

Performing [TV box control setup] in [TV box setup] allows you to control a TV box using the TV's remote control.

1. Press the  (Quick Settings) button on the remote control, then select [Settings] — [Channels & Inputs] — [External inputs] — [TV box setup] — [TV box control setup].

2. Follow the on-screen instructions.

Note

- When operating the TV's remote control, point it at the TV box.
- Depending on the external devices, some buttons may not respond.
- If you press and hold a button on the remote control, the operation may not work. Instead, try pressing the button repeatedly.
- The availability of this function depends on your model/region/country.

[48] Using the TV with Other Devices | Smartphones and tablets

Displaying the iPhone/smartphone or iPad/tablet app screen on the TV

Google Cast™ or AirPlay allows you to display (cast) your favourite websites and app screens on your mobile device directly to the TV.

Using Google Cast

1. Connect a mobile device such as a smartphone or tablet to the same home network that the TV is connected to.
2. Launch a Google Cast supported app on the mobile device.
3. Tap the Cast button from the app. ( (cast))
4. Select the TV as the cast destination.



The screen of the mobile device is displayed on the TV.

Note

- Google TV setup and an Internet connection are required to use Google Cast.



Using AirPlay

This TV supports AirPlay 2.

1. Make sure your Apple device is connected to the same network as your TV.
2. The procedure depends on the content that will be displayed on the TV as follows.
 - To display video, tap  (AirPlay Video).
 - To display photos, tap  (Action share).
 - To play music, tap  (AirPlay Audio).

- To display the screen of a mobile device, tap  (Mirroring).
(In some apps, you may have to tap another icon first.)
3. Select AirPlay on a mobile device such as an iPhone or iPad, and select the TV to use with AirPlay.

Hint

- The TV supports Apple HomeKit.
You can control the TV with a mobile device such as an iPhone or iPad by pressing the  (Input select) button on the remote control, selecting  (AirPlay), and following the on-screen instructions to setup Apple HomeKit.
Available operations vary depending on the version of the app and software.
- If you select [On (Powered on by apps)] in [Remote start], you can turn on the TV with apps on a mobile device such as an iPhone or iPad.
Press the  (Quick Settings) button on the remote control, then select [Settings] — [Network and Internet] — [Remote start] to change the setting.

Note

- Google TV setup and an Internet connection are required to use AirPlay.
- Operation of a mobile device such as iPhone or iPad varies depending on the OS version.

[49] Using the TV with Other Devices | Smartphones and tablets

BRAVIA Connect App

You can install the mobile app on your smartphone to operate this unit and set up a compatible audio system.



Note

- To maximise the features and performance of this TV and audio system, you may need to update the TV's software and the "Sony | BRAVIA Connect" app to the latest version.
- The availability of this function depends on your model/region/country.

Connecting a computer and viewing stored content

To connect a computer

Use an HDMI cable to connect your computer to the TV.

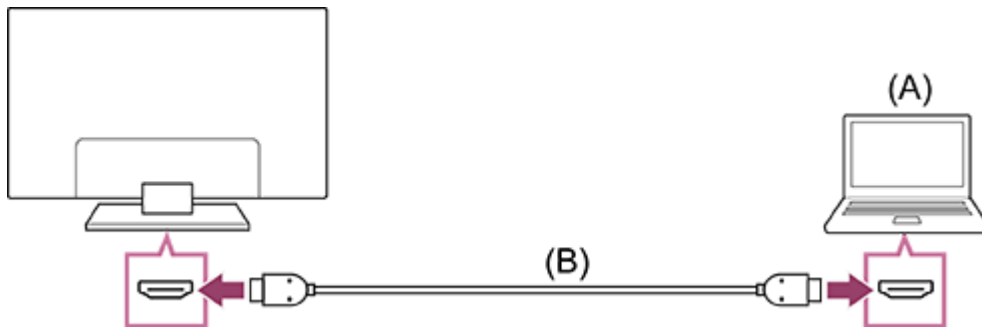

(A) Computer

(B) HDMI cable (not supplied)*

* Be sure to use an authorised Premium High Speed HDMI™ Cable(s) bearing the HDMI logo. We recommend an authorised Ultra High Speed HDMI™ Cable when connecting to a computer that supports 4K 120Hz.

To check the video signal specifications

- [Computer video signal specifications](#)

To view content stored on a computer

After connecting the computer, press the  (Input select) button, then select the input the computer is connected to.

To check the supported file formats

- [Photos](#)
- [Music](#)
- [Videos](#)
- [Audio sampling rates \(for videos\)](#)
- [External subtitles](#)

Note

- For optimum picture quality, we recommend that you set your computer to output video signals according to one of the timings listed in “[Computer video signal specifications](#)”.

- Depending on the connection status, the image may be blurred or smeared. In this case, change the computer's settings and select another input signal from the "Computer video signal specifications" list.

[51] Using the TV with Other Devices | Computers, cameras, and camcorders

Connecting a camera or camcorder and viewing stored content

To connect a camera or camcorder

Connect your Sony digital still camera or camcorder using an HDMI cable. Use a cable that has an HDMI mini jack (socket) for the digital still camera/camcorder end, and a standard HDMI jack (socket) for the TV end.

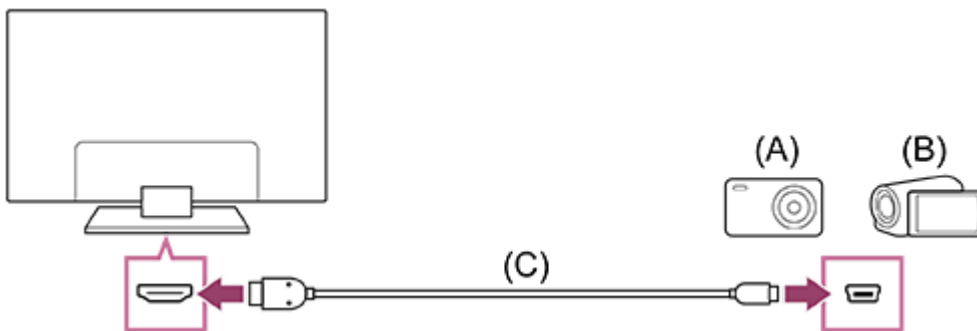

(A) Digital still camera

(B) Camcorder

(C) HDMI cable (not supplied)*

* Be sure to use an authorised Premium High Speed HDMI™ Cable(s) bearing the HDMI logo.

To view content stored on a digital still camera/camcorder

1. After connecting the digital still camera/camcorder, turn it on.
2. Press the  (Input select) button repeatedly to select the connected digital still camera/camcorder.
3. Start playback on the connected digital still camera/camcorder.

To check the supported file formats

- Photos
- Music
- Videos

- [Audio sampling rates \(for videos\)](#)
- [External subtitles](#)

Hint

- If you connect a BRAVIA Sync-compatible device, you can operate it by simply using the TV's remote control. Make sure that the device is BRAVIA Sync-compatible. Some devices may not be compatible with BRAVIA Sync even though they have an HDMI jack (socket).

[52] Using the TV with Other Devices | Computers, cameras, and camcorders

Computer video signal specifications

(Resolution, Horizontal frequency/Vertical frequency)

- 640 x 480, 31.5 kHz/60 Hz
- 800 x 600, 37.9 kHz/60 Hz
- 1024 x 768, 48.4 kHz/60 Hz
- 1152 x 864, 67.5 kHz/75 Hz
- 1280 x 1024, 64.0 kHz/60 Hz
- 1600 x 900, 55.9 kHz/60 Hz
- 1680 x 1050, 65.3 kHz/60 Hz
- 1920 x 1080, 67.5 kHz/60 Hz
- 3840 x 2160, 67.5 kHz/30 Hz
- 3840 x 2160, 135.0 kHz/60 Hz (8 bits)

Hint

- If your computer outputs 3840 x 2160p, 120Hz, you can use it as a video input signal.

Note

- The picture may be blurry and may not be displayed correctly depending on your connection status. In this case, change the computer's settings and select a different input signal in "Computer video signal specifications".

[53] Using the TV with Other Devices | Audio system (such as an AV receiver or sound bar)

Outputting audio from an audio system

You can connect audio systems such as AV receivers or sound bars to the TV. Select a connection method below according to the specifications of the audio system you want to connect.

- Connecting with an HDMI cable (For details, carefully read “Connection using an HDMI cable” below.)
- Connecting with a digital optical cable

For connection methods, refer to the [Connecting an audio system](#) page.

Note

- Refer to the instruction manual of the device to be connected.

Connection using an HDMI cable

This TV supports Audio Return Channel (ARC) or Enhanced Audio Return Channel (eARC). You can use an HDMI cable to output audio from audio systems that support ARC and eARC.

On TVs that support eARC, you can output (pass-through) audio signals from external input devices connected to the TV to eARC supported audio systems by using the HDMI terminal bearing the text “eARC/ARC”.

For connection methods, refer to the [Connecting an audio system](#) page.

Note

- The location of the HDMI terminal that supports eARC/ARC varies depending on the model. Refer to the included Setup Guide.

[54] Using the TV with Other Devices | Audio system (such as an AV receiver or sound bar)

Connecting an audio system

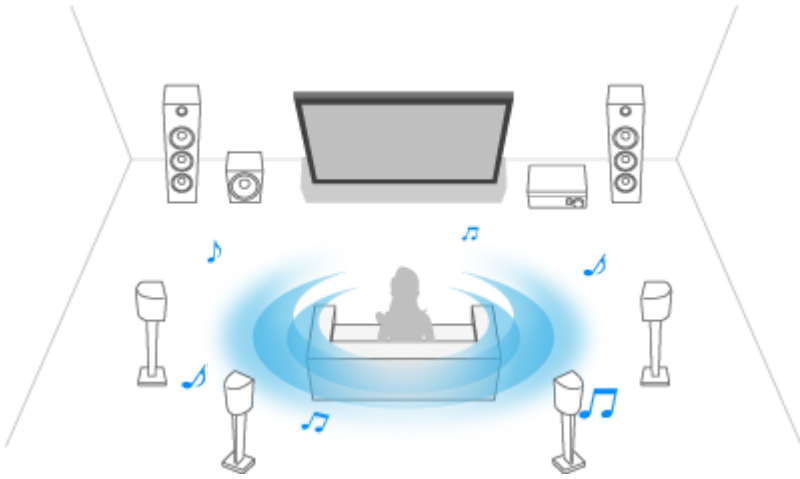

See the illustrations below to connect an audio system such as an AV receiver or sound bar.

To pair the TV with a Bluetooth device such as Bluetooth headphones, refer to [Connecting a Bluetooth device \(such as Bluetooth headphones\)](#).

Note

- The available terminals depend on your model/region/country.

Sound bar connection

We recommend connecting the TV's HDMI input terminal (eARC or ARC) to the sound bar's HDMI output terminal (eARC or ARC) with an HDMI cable.

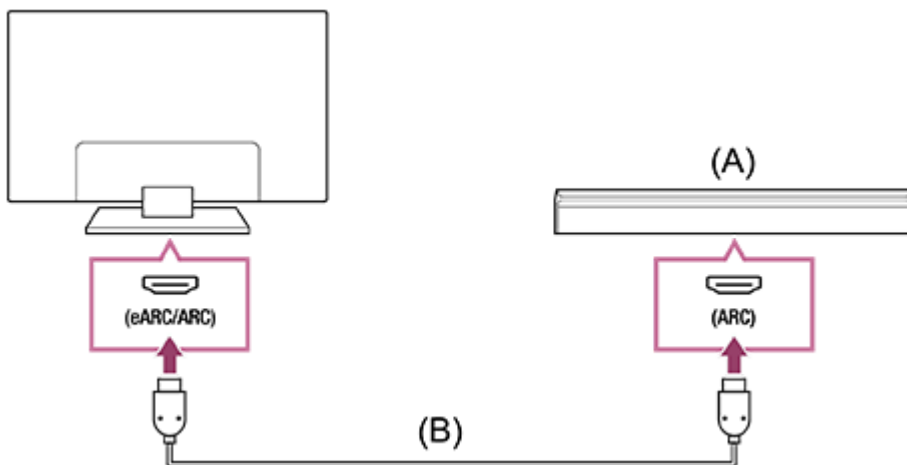

(A) Sound bar

(B) HDMI cable (not supplied)*

* We recommend an authorised Premium High Speed HDMI™ Cable(s).

To connect a sound bar via HDMI, see “HDMI connection”.

If you connect the TV to a sound bar via HDMI, you can use the following features.

- Link the power state of the sound bar and TV

- Display and configure the sound bar settings on the TV (depends on your model)

Note

- The available functions depend on the sound bar.
- Depending on the sound bar, “eARC” or “ARC” may not be indicated on the HDMI terminal. For details on how to connect, refer to the sound bar manual.

Hint

There may be three tactile dots, next to the HDMI input terminal depending on your model. Use them as a guide during installation.

Audio amp connection

We recommend connecting the TV's HDMI input terminal (eARC or ARC) to the sound bar's HDMI output terminal (eARC or ARC) via HDMI. Depending on your audio system, you can also connect with a digital optical cable.

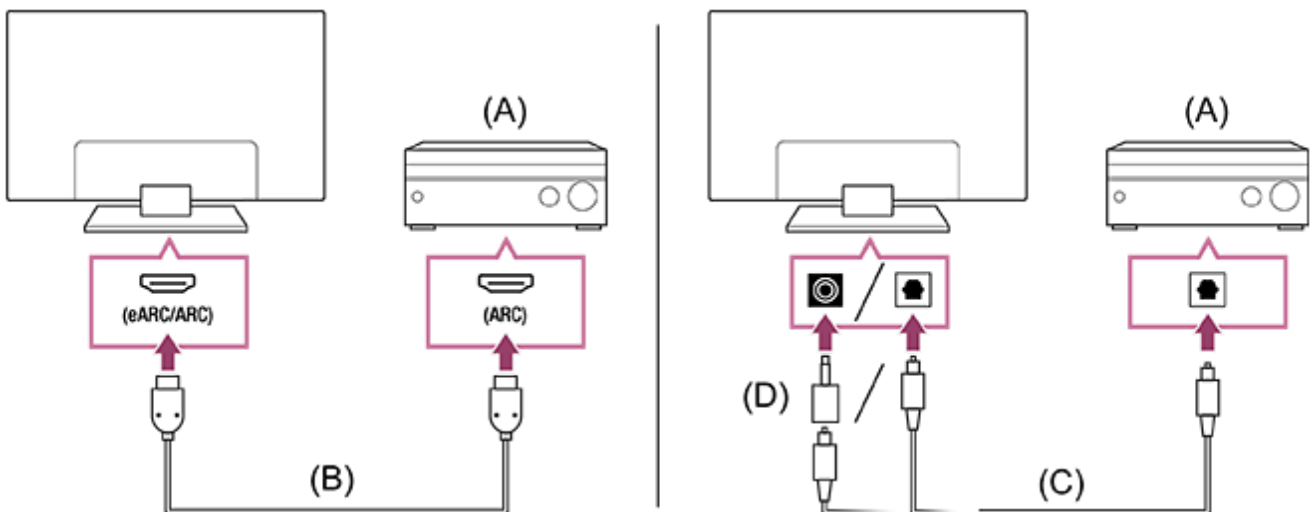

(A) Audio amp

(B) HDMI cable (not supplied)*

(C) Digital optical cable (not supplied)

(D) Digital audio connector adapter (only supplied with compatible models)

* We recommend an authorised Premium High Speed HDMI™ Cable(s).

To connect an audio amp via HDMI, see “HDMI connection”. To connect an audio amp with a digital optical cable, see “Digital optical cable connection”.

Note

- ALWAYS keep small accessories out of the reach of children, so that they are not mistakenly swallowed.

HDMI connection (eARC supported)

1. Connect the external input device and TV with an HDMI cable. Connect the TV and audio system with another HDMI cable.
Connect the audio system to the TV's HDMI input terminal bearing the text "ARC" or "eARC/ARC".

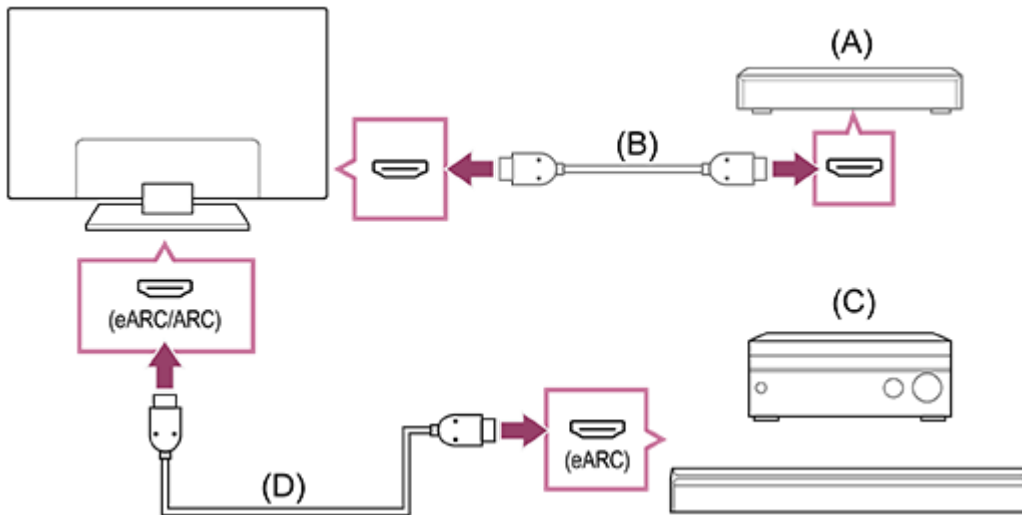

- (A) External input device (such as a Blu-ray/DVD recorder)
(B) HDMI cable (not supplied)
(C) AV receiver or sound bar
(D) HDMI cable with Ethernet (not supplied)*

* We recommend authorised Premium High Speed HDMI™ Cable(s) bearing the HDMI logo.

2. Press the  (Quick Settings) button on the remote control, then select [Settings] — [Display & Sound] — [Audio output] — [Audio system settings] — [eARC setting] — [Auto].
3. Select [Audio output] — [Speakers] — [Audio system].
4. Enable the audio system's eARC feature.
Refer to the instruction manual of the device.
5. Adjusting an audio system

Note

- If [Digital audio output] is set to [Prioritise pass through], the TV operates as follows for some audio signal:

audio from system sounds and audio responses is not output, and the voice recognition performance of the built-in MIC may degrade (only TVs with a built-in MIC).

Hint

There may be three tactile dots next to the HDMI input terminal depending on your model. Use them as a guide during installation.

HDMI connection (ARC supported)

1. Connect the TV and audio system with an HDMI cable.
Connect to the TV's HDMI input terminal bearing the text "ARC" or "eARC/ARC".

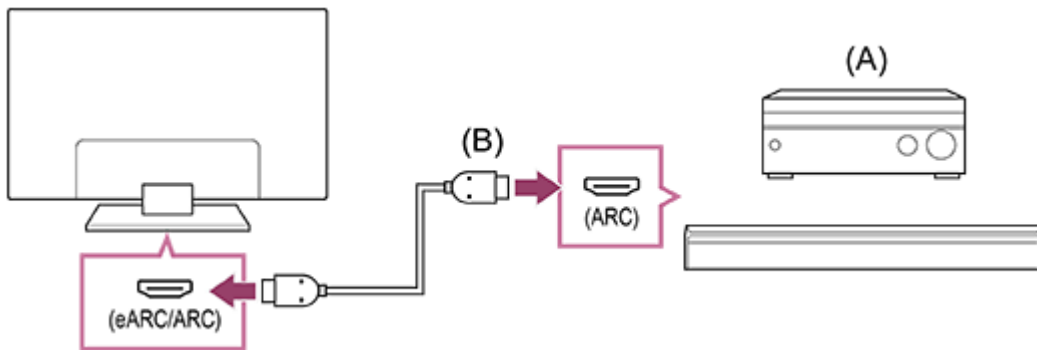

(A) AV receiver or sound bar

(B) HDMI cable (not supplied)*

* We recommend authorised Premium High Speed HDMI™ Cable(s) bearing the HDMI logo.

2. Adjusting an audio system

Note

- For ARC connections, voice recognition performance may degrade (only TVs with a built-in MIC).
- If [Digital audio output] is set to [Prioritise pass through], the TV operates as follows for some audio signal:
 - audio from system sounds and audio responses is not output, and
 - the voice recognition performance of the built-in MIC may degrade (only TVs with a built-in MIC).

Hint

There may be three tactile dots next to the HDMI input terminal depending on your model. Use them as a guide during installation.

Digital optical cable connection

1. Connect the TV and audio system with a digital optical cable.
Connect to the audio system's digital optical input terminal.

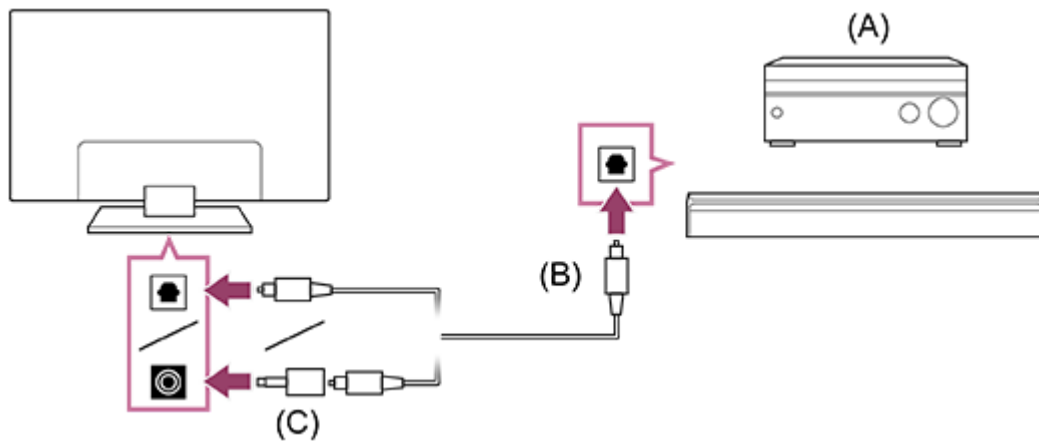

(A) AV receiver or Sound bar

(B) Optical audio cable (not supplied)

(C) Digital audio connector adapter (only supplied with compatible models)

- To enable [Optical digital audio output], press the  (Quick Settings) button on the remote control, then select [Settings] — [Display & Sound] — [Audio output] — [Optical digital audio output settings] — [Optical digital audio output].

3. Adjusting an audio system

Note

- ALWAYS keep small accessories out of the reach of children, so that they are not mistakenly swallowed.

Hint

HDMI connection centred on an audio system (eARC supported)

You can make connections centred on an audio system as follows.

For TV settings, refer to HDMI connection (eARC supported). For the audio system settings, refer to your device manual.

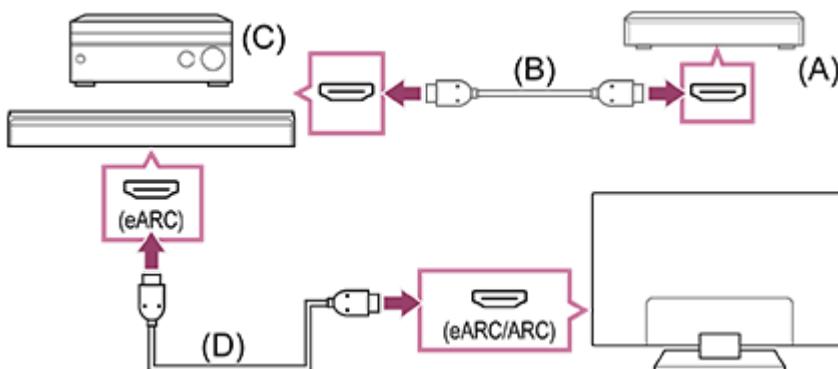

(A) External input device (such as a Blu-ray/DVD recorder)

(B) HDMI cable (not supplied)

(C) AV receiver or sound bar

(D) HDMI cable with Ethernet (not supplied)*

* We recommend authorised Premium High Speed HDMI™ Cable(s) bearing the HDMI logo.

[55] Using the TV with Other Devices | Audio system (such as an AV receiver or sound bar)

Adjusting an audio system

After connecting an audio system to the TV, adjust the TV's audio output from the audio system.

Adjusting an audio system connected with an HDMI cable or digital optical cable

1. After connecting the TV to your audio system, press the  (Quick Settings) button on the remote control, then select [Settings] — [Display & Sound] — [Audio output] — [Speakers] — [Audio system].
2. Turn on the connected audio system, then adjust the volume.
If you connect a BRAVIA Sync-compatible device with an HDMI connection, you can operate it by simply using the TV's remote control.

Note

- You need to configure the [Digital audio output] settings according to your audio system. Press the  (Quick Settings) button on the remote control, then select [Settings] — [Display & Sound] — [Audio output] — [Audio system settings] (with the HDMI cable connected) or [Optical digital audio output settings] (with the optical digital cable connected) — [Digital audio output].

[PCM]

Set this option if your audio system does not support Dolby Digital or DTS.

Hint

- If a specific audio system is connected with an HDMI cable, you can adjust the output timing of the picture and sound.

[Adjusting the AV sync setting](#)

[56] Using the TV with Other Devices | Audio system (such as an AV receiver or sound bar)

Using the TV as a centre speaker

You can use the TV as a centre speaker by connecting a device such as a sound bar with an S-CENTER OUT terminal to the TV's S-CENTER SPEAKER IN terminal. Conversations sound natural because you can hear them coming from the screen and its vicinity.

Hint

- For Acoustic Center Sync supported audio systems with an S-CENTER OUT terminal, refer to the following.

https://www.sony.net/hav_faq



https://www.sony.net/hav_faq

- Models with a CENTER SPEAKER IN terminal can also be used as a centre speaker by connecting the audio system with a speaker cable.

1. Connect the TV and Acoustic Center Sync supported audio system with the TV centre speaker mode cable that was supplied with the supported device.

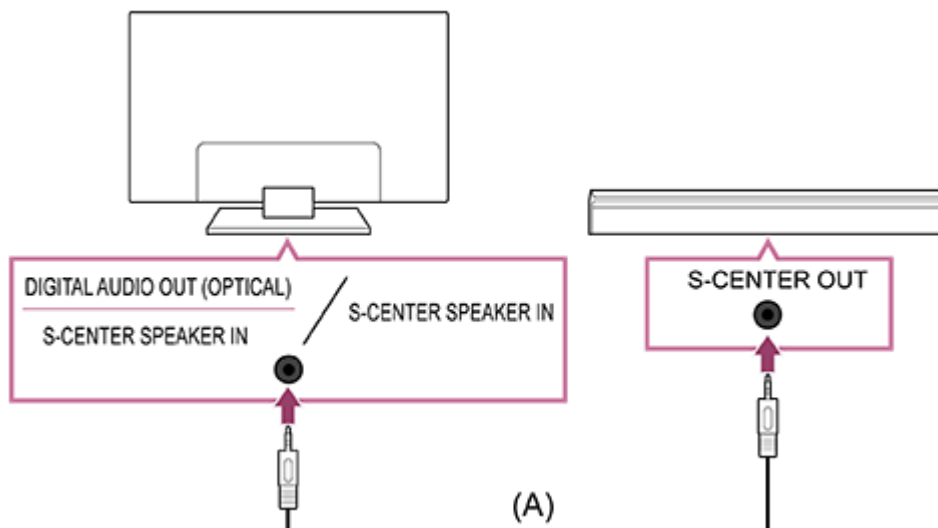

(A) TV centre speaker mode cable (supplied with devices such as sound bars that have S-CENTER OUT terminals)

Note

- Even when connecting an audio system with an S-CENTER OUT terminal, it must be connected to the TV with an HDMI cable like a normal sound bar.

- Also refer to the instruction manual of the audio system with an S-CENTER OUT terminal.
- For models that are sharing the same terminal of S-CENTER SPEAKER IN and DIGITAL AUDIO OUT (OPTICAL), optical audio output is not available when using S-CENTER SPEAKER IN.

2. Press the  (Quick Settings) button on the remote control, then select [Settings] — [Display & Sound] — [Audio output] — [Speakers] — [Audio system].

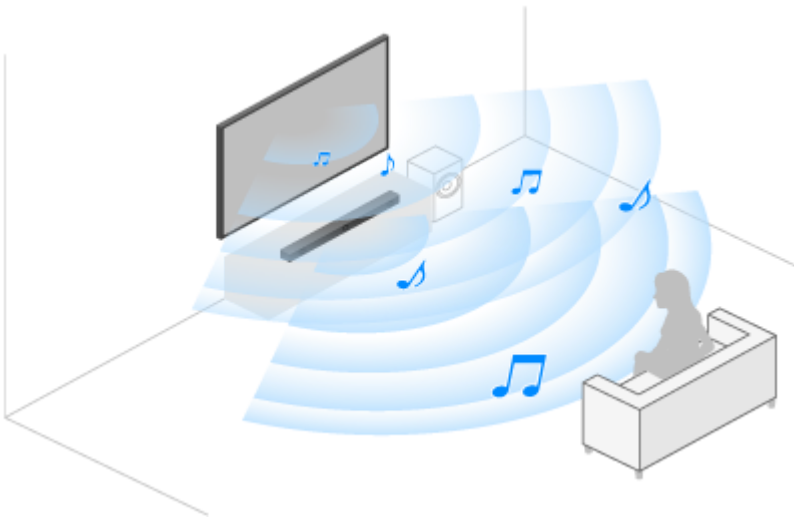

Note

- If centre audio is not output from the TV, enable [Settings] — [Display & Sound] — [Audio output] — [Audio system settings] — [Acoustic Center Sync].

Connecting an AV receiver with a speaker cable (only models with a CENTER SPEAKER IN terminal)

Connect the TV and AV receiver with a speaker cable.

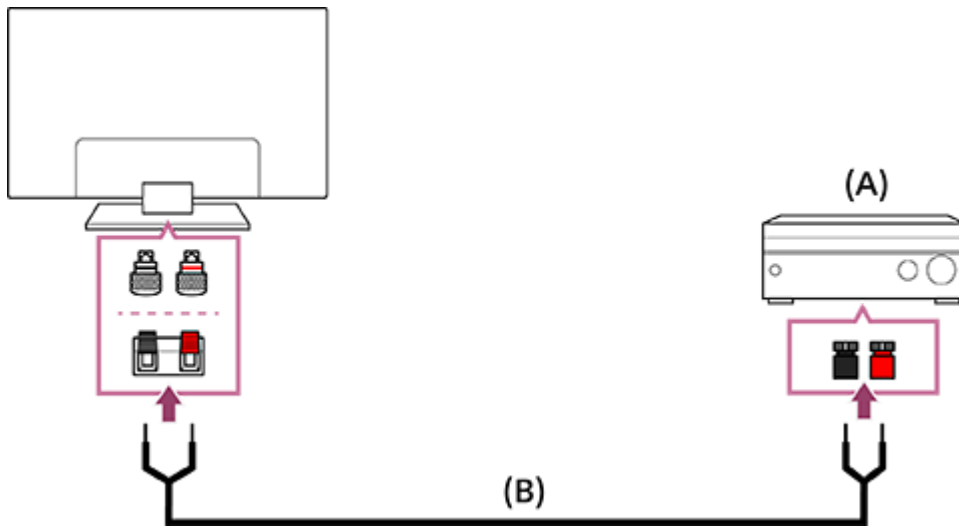

(A) AV receiver

(B) Speaker cable (not supplied)

Use a speaker cable (not supplied) to connect the AV receiver to the CENTER SPEAKER IN terminal of the TV.

When connecting, make sure to twist the ends of the speaker cable and insert them into the connection terminals of the TV and AV receiver.

The CENTER SPEAKER IN terminal varies depending on the model. Refer to the figures below when connecting the speaker cable.



*Strip about 10 mm (13/32 inches) of insulation from the speaker cable at each end.

Note

- To prevent the wires of the speaker cable from touching each other, make sure not to strip too much of the speaker cable.
- Connect the speaker cable properly so that the polarities (+/-) between the TV and AV receiver match.

Audio formats

HDMI IN 1/2/3/4

In eARC (Enhanced Audio Return Channel) mode

- 7.1 channel linear PCM: 32/44.1/48/88.2/96/176.4/192 kHz
- Dolby Audio
- Dolby Atmos
- DTS
- DTS Express
- DTS-HD Master Audio
- DTS-HD High Resolution Audio
- DTS:X

Except eARC mode

- 7.1 channel linear PCM: 32/44.1/48/88.2/96/176.4/192kHz
- Dolby Audio
- Dolby Atmos
- DTS
- DTS Express
- DTS-HD Master Audio
- DTS-HD High Resolution Audio
- DTS:X

eARC/ARC (Enhanced Audio Return Channel/Audio Return Channel) (HDMI IN 3 only)

In eARC mode

- 7.1 channel linear PCM: 32/44.1/48/88.2/96/176.4/192 kHz
- Dolby Audio
- Dolby Atmos
- DTS
- DTS-HD Master Audio
- DTS-HD High Resolution Audio
- DTS:X

In ARC mode

- Two channel linear PCM: 48kHz 16bits
- Dolby Audio
- Dolby Atmos

- DTS

[58] Using the TV with Other Devices | Audio system (such as an AV receiver or sound bar)

Accessing audio system settings

You can access the audio system (such as an AV amplifier or sound bar) settings such as audio quality from the TV's Quick Settings.



1. Connect the audio system via the HDMI (eARC/ARC) terminal.
2. Press the  (Quick Settings) button on the remote control, and select an audio system setting.
 - For details about audio system settings, please refer to your audio system's manual.
 - If the connected audio system is compatible with Voice Zoom 3, [Voice Zoom] for audio system will be displayed.

Note

- Audio system settings are displayed only for supported models. For information about supported models, refer to the support site.

https://www.sony.net/hav_faq



https://www.sony.net/hav_faq

- The settings that are displayed depend on the audio system model.
- When [Voice Zoom] is enabled, if sound is changed to output from the audio system and Bluetooth headphones or speakers simultaneously, [Voice Zoom]

will be disabled automatically. If the simultaneous sound output stops, the [Voice Zoom] will be enabled again.

Hint

- For settings that are not displayed by default, select settings to add from **+** (Edit).

[59] Using the TV with Other Devices

Video game consoles

Connecting

Connect an HDMI-supported video game console to your TV with an HDMI cable. To connect an audio amp or sound bar at the same time, refer to HDMI connection (eARC supported) in [Connecting an audio system](#).

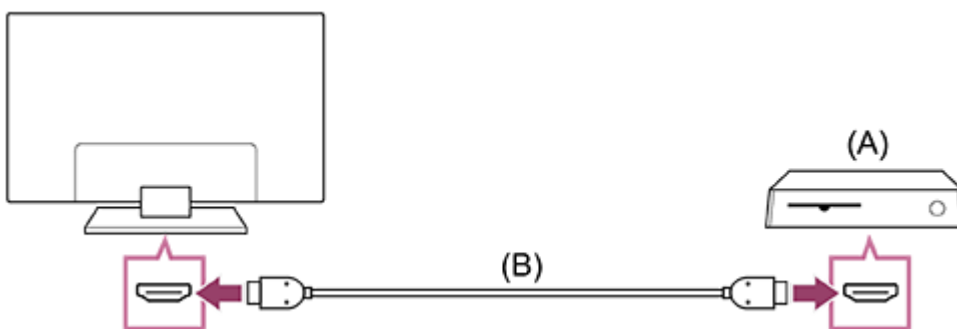

- (A) Video game console
- (B) HDMI cable (sold separately)

Hint

- A Premium High Speed HDMI™ Cable(s) is fine for general purposes, but if you want to connect a video game console that supports 4K 120Hz, use the HDMI cable included with the game console, or an Ultra High Speed HDMI™ Cable.
- The type and position of the HDMI port differs depending on your TV. Refer to the documentation provided with the TV.

Changing HDMI input settings

After connecting, set the connected HDMI input port.

To maximise the performance of your TV and video game console, set the [HDMI signal format/VRR].

Auto setup

1. With the video game console turned on, connect it to the TV with an HDMI cable.
Set by following the instructions on the TV screen.

Manual setup

1. Press the  (Quick Settings) button on the remote control, and select the following in order.
[Settings] — [Channels & Inputs] — [External inputs] — [HDMI signal format/VRR]

Select the optimal format for your video game console.

Hint

- If you connect a video game console that supports 4K 120 Hz video output, set to [Enhanced format (Advanced)].
- If you connect a video game console that supports VRR, enable [VRR (Variable Refresh Rate)].

Note

- When connecting a video game console that supports 4K 120Hz and VRR, check the label of the HDMI input ports on the TV and connect to the HDMI input port that is labelled 4K 120Hz or connect to the HDMI input port that is displayed as [VRR (Variable Refresh Rate)] for [HDMI signal format].
The available [HDMI signal format] depends on the model. Some HDMI formats may also not be supported depending on the model/region/country.
- If [VRR (Variable Refresh Rate)] is enabled, slight brightness fluctuations (flicker) may occur on the TV screen depending on the frequency of the content output from the connected video game console.

Viewing the Gaming multi view

1. In the Game Menu, select [Gaming multi view on YouTube] or playback a video searched with [YouTube quick search].
HDMI content will be displayed on the left side and YouTube content will be displayed on the right side.
Use the remote control to operate YouTube content.

Hint

- Multi view screen will only be displayed when input is HDMI and [Content type] in [Settings] is set to [Game].

Available settings in Gaming multi view

1. Press the MENU button on the remote control to change the settings.
2. Press the ◀ (Left) or ▶ (Right) buttons on the remote control to switch between screens.
The selected screen will have a white frame, and menu will be displayed at the bottom of the screen.
3. Press the ▼ (Down) button on the remote control to transition to menu selection and select the menu with the ◀ (Left) or ▶ (Right) buttons on the remote control.

Audio mix

You can change the percentage of sound output from the left and right screens.

Change screen size

You can choose the size of the left and right screens.

Full screen

Return to Full screen.

4. Press the -|- (Enter) button on the remote control when the selected screen has a white frame. The menu will disappear and you can operate within the selected screen.

Hint

- Other methods to return to Full screen.

When the Gaming multi view menu is displayed, press the ↶ (BACK) button or the MENU button to hide the menu.

Press the ↶ (BACK) button again to display the Exit menu.

Select Exit in the Exit menu to return to Full screen.

Perform input switching by pressing the ↷ (Input select) button on the remote control.

Note

- When Gaming multi view is displayed, the delay in the game increases.
- Specifications may be subject to change without notice.

Experiencing 3D surround with a neckband speaker or headphones

You can use a neckband speaker or Sony brand headphones to experience 3D surround (spatial sound).

For details, refer to the URL below.

<https://www.sony.net/bravia-xr-3ds2>



<https://www.sony.net/bravia-xr-3ds2>

[61] Using the TV with Other Devices | Bluetooth devices (such as Bluetooth headphones)

Connecting a Bluetooth device (such as Bluetooth headphones)

To pair the TV with a Bluetooth device

1. Turn the Bluetooth device such as Bluetooth headphones on and put it in pairing mode.

To put your Bluetooth device in pairing mode, refer to the instruction manual of the device.

2. Press the  (Quick Settings) button on the remote control, then select [Settings] — [Remotes and accessories] — [Pair accessory] to put the TV in pairing mode.

Available Bluetooth devices will be displayed.

3. Select the desired device, then follow the on-screen instructions.

If you are prompted to enter a passcode, refer to the instruction manual of the device.

After pairing is completed, the device connects to the TV.

Hint

- For more information on compatible audio devices, visit the following URL.

<https://www.sony.net/bluetooth-connection/>



<https://www.sony.net/bluetooth-connection/>

- You can pair some models of Sony headphones to experience realistic 3D surround sound. For details, visit the following URL.

<https://www.sony.net/bravia-xr-3ds2>



<https://www.sony.net/bravia-xr-3ds2>

- To output sound from the TV speakers and Bluetooth headphones or speakers simultaneously, press the  (Quick Settings) button on the remote control and select [Audio output] while the Bluetooth headphones or speakers are paired. Then, set the following functions from the items that are displayed.

For [Speakers], select [TV speakers].

For [Bluetooth device], select the paired Bluetooth device from which you want to output sound.

Note

- When sound is output from the TV speakers and Bluetooth headphones or speakers simultaneously, [Voice Zoom] will not be available.

To connect to a paired Bluetooth device

1. Press the  (Quick Settings) button on the remote control, then select [Settings] — [Remotes and accessories].
2. Select a paired but unconnected device.
3. Select [Connect].

Note

- When a sound bar and the TV are connected through Bluetooth, connect the external input device such as a Blu-ray/DVD recorder to the TV.

Supported Bluetooth profiles

The TV supports the following profiles:

- HID (Human Interface Device Profile)
 - HOGP (HID over GATT Profile)
 - A2DP (Advanced Audio Distribution Profile)
 - AVRCP (Audio/Video Remote Control Profile)
 - SPP (Serial Port Profile)
-

[63] Using the TV with Other Devices

Adjusting the AV sync setting

If a Bluetooth audio device is connected, there may be a delay between the picture and sound due to the properties of Bluetooth. You can adjust the delay between the picture and sound with the AV sync setting.

1. Press the  (Quick Settings) button on the remote control, then select [Settings] — [Display & Sound] — [Audio output] — [Bluetooth device settings] — [AV sync] — the desired option.

If the audio device is connected with an HDMI cable, the sound may be delayed due to the properties of the audio device. In that case, you can adjust the video and audio output timing with the AV sync setting.

1. Press the  (Quick Settings) button on the remote control, and then select the following in order.
[Settings] — [Display & Sound] — [Audio output] — [Audio system settings] — [AV sync] — the desired setting

Note

- Depending on the connected Bluetooth audio device or connected HDMI device, the picture and sound may not match even when the [AV sync] setting is set to [On] or [Auto].
- Even if the [AV sync] setting is [Auto], the video and audio output timing cannot be adjusted when [Content type] is set to the following. The [AV sync] setting is fixed to [Off] and cannot be changed.

[Game]

[PC]

- Even if the [AV sync] setting is set to [Auto], the video and audio output timing is not adjusted when [Content type] — [Video/Images] and [Picture mode] — [Photo].

[64] Using the TV with Other Devices | BRAVIA Sync-compatible devices

BRAVIA Sync overview

If a BRAVIA Sync-compatible device (e.g., Blu-ray player, AV receiver) is connected with an HDMI cable, you can operate the device with the TV's remote control.

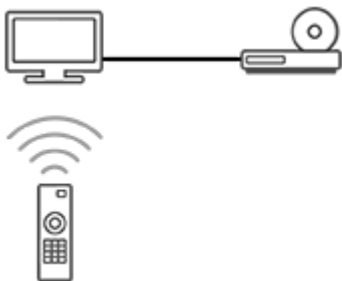





[65] Using the TV with Other Devices | BRAVIA Sync-compatible devices



Using features available for BRAVIA Sync-compatible devices

To operate BRAVIA Sync-compatible devices from the TV, use the  (Input select) button on the remote control to select the device you want to operate.





Blu-ray/DVD player

- Automatically turns the TV on and switches the input to the connected Blu-ray/DVD player when the Blu-ray/DVD player starts to play.
- Automatically turns the connected Blu-ray/DVD player off when you turn the TV off.
- Allows operations such as menu operation and playback with the  (Up) /  (Down) /  (Left) /  (Right) buttons on the TV remote control.

AV receiver

- Automatically turns the connected AV receiver on and switches the sound output from the TV speaker to the audio system when you turn the TV on. This function is only available if you have previously used the AV receiver to output the TV's sound.
- Automatically switches the sound output to the AV receiver by turning the AV receiver on when the TV is turned on.
- Automatically turns the connected AV receiver off when you turn the TV off.
- Adjusts the volume ( (Volume) +/- buttons) and mutes the sound ( (Mute) button) of the connected AV receiver through the TV's remote control.

Video camera

- Automatically turns the TV on and switches the input to the connected video camera when the camera is turned on.
- Automatically turns the connected video camera off when you turn the TV off.
- Allows operations such as menu operation and playback with the  (Up) /  (Down) /  (Left) /  (Right) buttons on the TV remote control.

[66] Using the TV with Other Devices | BRAVIA Sync-compatible devices

Adjusting BRAVIA Sync settings

BRAVIA Sync is a feature that enables your television's remote to control other BRAVIA Sync-compatible equipment, through the use of the HDMI CEC (Consumer Electronics Control) technology.

When BRAVIA Sync is set up, you will be able to turn off a connected device with the TV or set a device connected via HDMI cable to be operated with the TV's remote control.

1. Turn on the connected device.
2. To enable [BRAVIA Sync control], press the  (Quick Settings) button on the remote control, then select [Settings] — [Channels & Inputs] — [External inputs] — [BRAVIA Sync settings] — [BRAVIA Sync control].

3. Activate BRAVIA Sync on the connected device.

When a specific Sony BRAVIA Sync-compatible device is connected and powered on and [BRAVIA Sync control] is enabled, BRAVIA Sync is automatically activated on that device. For details, refer to the instruction manual of the connected device.

Available options

Available options are shown below. (Options vary depending on your model/region/country.)

[Auto devices off]

If disabled, the connected device does not turn off automatically when the TV is turned off.

[Auto TV on]

If disabled, the TV does not turn on automatically when the connected device is turned on.

[BRAVIA Sync device list]

Displays the BRAVIA Sync device list.

[67] Using the TV with Other Devices | Viewing pictures in 4K from compatible devices

Viewing pictures in 4K resolution

You can connect a digital still camera/camcorder that supports HDMI 4K output to HDMI IN of the TV to display high resolution photos stored on the camera. You can also display high resolution photos stored in connected USB devices or your home network. A picture with a 4K or higher resolution can be displayed in 4K resolution (3840×2160).

The availability of this function depends on your region/country.

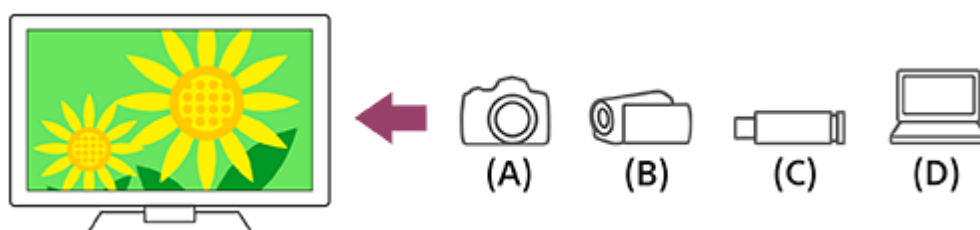

- (A) Digital still camera
- (B) Camcorder
- (C) USB device
- (D) Network device

To view pictures stored on a USB device or network device in 4K resolution

1. Connect the USB device or network device to the TV.
2. Press the  (HOME) button, and select Apps from the Home menu, then select [Media Player].
3. Select the USB device name or network device name.
4. Select the folder, and then select the file to play.

To view pictures stored on a digital still camera/camcorder

1. Connect a digital still camera or camcorder that supports HDMI output to the HDMI IN jack (socket) of the TV, using an HDMI cable.
2. Press the  (Input select) button repeatedly to select the connected device.
3. Set the connected device to 4K output.
4. Start playback on the connected device.

To check the supported file formats

- [Photos](#)
- [Music](#)
- [Videos](#)
- [Audio sampling rates \(for videos\)](#)
- [External subtitles](#)

To view pictures in 4K resolution with higher quality

You can set the HDMI signal format to Enhanced format to view pictures in 4K resolution with higher quality.

For information about Enhanced format or changing the settings, refer to the [Settings for viewing pictures through HDMI input with higher quality](#) page.

Note

- A 3D picture cannot be displayed.
- If you change the picture by pressing the ◀ (Left) / ▶ (Right) buttons, it may take a moment for the picture to be displayed.

[68] Using the TV with Other Devices | Viewing pictures in 4K from compatible devices

Settings for viewing pictures through HDMI input with higher quality

To display a picture from a device connected to the HDMI input terminal in a higher quality HDMI format^{*1}, set [HDMI signal format/VRR] in [External inputs].

^{*1} Such as 4K 100/120 Hz, 4K 60p 4:2:0 10 bit, 4K 60p 4:4:4, or 4:2:2

HDMI signal format

To change the HDMI signal format setting, press the 🔑 (Quick Settings) button on the remote control, then select [Settings] — [Channels & Inputs] — [External inputs] — [HDMI signal format/VRR] — the HDMI input you want to set.

Follow the on-screen instructions, and set the HDMI signal format for the HDMI input terminal to a suitable format below. Available HDMI signal formats depend on your model and the HDMI input.

- Standard format
- Enhanced format
- Enhanced format (Advanced)

Note

- Support for the display of 4K 100/120 Hz picture depends on your model/region/country.
- Support for the Variable Refresh Rate (VRR) feature depends on your model.
- When using Enhanced format, picture and sound may not be output correctly. In this case, connect the device to an HDMI IN that is in [Standard format], or change the HDMI signal format of HDMI IN to [Standard format].
- Only set to Enhanced format when using compatible devices.
- When you watch 4K picture with High-Quality, use a Premium High Speed HDMI™ Cable(s) that supports speeds of 18 Gbps. For details on a Premium High Speed HDMI™ Cable(s) that supports 18 Gbps, refer to the cable specifications.

- To display 4K 100/120 Hz or 8K picture, an Ultra High Speed HDMI™ Cable that supports 48 Gbps is required. Refer to the cable specifications to find out whether a cable supports 48 Gbps.

[69] Using the TV with Other Devices

BRAVIA Connectivity Guide

Descriptions about connecting devices to the TV are also available on the Sony support website. Refer to it as necessary.

https://www.sony.net/tv_connectivity_guide/



https://www.sony.net/tv_connectivity_guide/

[70] Using the TV with Other Devices | Supported files and formats

Photos

To enjoy photos, you may need to update the TV's software.

Use case : USB / Home Network

File Format	Extension
JPEG	*.jpg / *.jpe / *.jpeg
HEIF	*.heic / *.heif / *.hif
ARW ^{*1}	*.arw

^{*1} ARW is only to be used for playing back files.

Other supported files and formats

- Music

- [Videos](#)
- [Audio sampling rates \(for videos\)](#)
- [External subtitles](#)

[71] Using the TV with Other Devices | Supported files and formats

Music

Use case : USB / Home Network

mp4

Extension: *.mp4 / *.m4a

Description	Sampling Rate
AAC-LC	16k / 22.05k / 24k / 32k / 44.1k / 48k
HE-AAC v1 / v2	24k / 32k / 44.1k / 48k

3gpp

Extension: *.3gp / *.3g2

Description	Sampling Rate
AAC-LC	16k / 22.05k / 24k / 32k / 44.1k / 48k
HE-AAC v1 / v2	24k / 32k / 44.1k / 48k

Asf

Extension: *.wma

Description	Sampling Rate
WMA9 Standard	8k / 11.025k / 16k / 22.05k / 32k / 44.1k / 48k

ogg

Extension: *.ogg

Description	Sampling Rate
Vorbis	8k / 11.025k / 16k / 22.05k / 32k / 44.1k / 48k

Other

Description	Sampling Rate
LPCM ^{*1}	32k / 44.1k / 48k

Extension: *.mp3

Description	Sampling Rate
MP1L1 / MP1L2 / MP1L3 / MP2L1 / MP2L2	32k / 44.1k / 48k
MP2L3	16k / 22.05k / 24k
MP2.5L3	8k / 11.025k / 12k

Extension: *.wav

Description	Sampling Rate
WAV ^{*2}	32k / 44.1k / 48k / 88.2k / 96k / 176.4k / 192k

Extension: *.flac

Description	Sampling Rate
FLAC	16k / 22.05k / 32k / 44.1k / 48k / 88.2k / 96k / 176.4k / 192k

Extension: *.aac

Description	Sampling Rate
AAC-LC	16k / 22.05k / 24k / 32k / 44.1k / 48k

Description	Sampling Rate
HE-AAC v1 / v2	24k / 32k / 44.1k / 48k

*1 The use case of LPCM is Home Network only.

*2 The use case of WAV is 2ch only.

Other supported files and formats

- [Photos](#)
- [Videos](#)
- [Audio sampling rates \(for videos\)](#)
- [External subtitles](#)

[72] Using the TV with Other Devices | Supported files and formats

Videos

Use case : USB / Home Network

MPEG1 (*.mpg / *.mpe / *.mpeg)

Subtitle Type : External

Video Codec (Profile@Level)	Audio Codec	Max. / Min. Resolution	Max. Frame Rate
MPEG1	MPEG1L2	1920x1080 / QCIF (176x144)	1920x1080@30fps / 1280x720@60fps

MPEG2PS (*.mpg / *.mpe / *.mpeg)

Subtitle Type : External

Video Codec (Profile@Level)	Audio Codec	Max. / Min. Resolution	Max. Frame Rate
MPEG2 MP@HL, MP@H14L, MP@ML	MPEG1L1 / MPEG1L2 / LPCM / AC3	1920x1080 / QCIF (176x144)	1920x1080@30fps / 1280x720@60fps

MPEG2TS

Extension : *.m2t

Subtitle Type : External

Video Codec (Profile@Level)	Audio Codec	Max. / Min. Resolution	Max. Frame Rate
MPEG2 MP@HL, MP@H14L, MP@ML	MPEG1L1 / MPEG1L2 / AAC-LC / HE-AAC v1 / HE-AAC v2 / AC3 / E-AC3	1920x1080 / QCIF (176x144)	1920x1080@30fps / 1280x720@60fps

Extension : *.m2ts / *.mts

Subtitle Type : External

Video Codec (Profile@Level)	Audio Codec	Max. / Min. Resolution	Max. Frame Rate
AVC / H.264 BP@L3, MP@L4.2, HP@L4.2	MPEG1L1 / MPEG1L2 / AAC-LC / HE-AAC v1 / HE-AAC v2 / AC3 / E- AC3	1920x1080 / QCIF (176x144)	1920x1080@60fps

MP4 (*.mp4)

Subtitle Type : External

Video Codec (Profile@Level)	Audio Codec	Max. / Min. Resolution	Max. Frame Rate
AVC / H.264 BP@L3, MP@L4.2, HP@L4.2	AAC-LC / HE-AAC v1 / HE-AAC v2 / AC3 / E-AC3 / AC4 / MPEG1L1 / MPEG1L2	1920x1080 / QCIF (176x144)	1920x1080@120fps

Video Codec (Profile@Level)	Audio Codec	Max. / Min. Resolution	Max. Frame Rate
MPEG4 SP@L6, ASP@L5, ACEP@L4	AAC-LC / HE-AAC v1 / HE-AAC v2 / AC3 / E-AC3 / MPEG1L1 / MPEG1L2	1920x1080 / QCIF (176x144)	1920x1080@30fps / 1280x720@60fps
AVC / H.264 BP@L5.2, MP@L5.2, HP@L5.2 *1	AAC-LC / HE-AAC v1 / HE-AAC v2 / AC3 / E-AC3 / AC4 / LPCM	3840x2160 / QCIF (176x144)	3840x2160@60p / 1920x1080@120fps
HEVC / H.265 MP@L5.1, Main10@L5.1	AAC-LC / HE-AAC v1 / HE-AAC v2 / AC3 / AC4 / E-AC3	3840x2160 / QCIF (176x144)	3840x2160@60p / 1920x1080@120fps
HEVC / H.265 MP@L6, MP10@L6	LPCM	3840x2160 / QCIF (176x144)	3840x2160@120fps (XAVC v2) / 3840x2160@60fps
AVC BL@L6, HP@L6, HP10@L6	AAC-LC / HE-AAC v1 / HE-AAC v2 / AC3 / AC4 / E-AC3	3840x2160 / QCIF (176x144)	3840x2160@120fps (XAVC v2) / 3840x2160@60fps
HEVC / H.265 MP@L6, MP10@L6	AAC-LC / HE-AAC v1 / HE-AAC v2 / AC3 / AC4 / E-AC3	3840x2160 / QCIF (176x144)	3840x2160@60fps

*1 This line includes the XAVC S format use case. The maximum supported bitrate for XAVC S is 100 Mbps.

avi (*.avi)

Subtitle Type : External

Video Codec (Profile@Level)	Audio Codec	Max. / Min. Resolution	Max. Frame Rate
Motion JPEG	μ-LAW / PCM (U8) / PCM (S16LE)	1280x720 / QCIF (176x144)	1280x720@30fps

Asf (*.asf / *.wmv)

Subtitle Type : External

Video Codec (Profile@Level)	Audio Codec	Max. / Min. Resolution	Max. Frame Rate
MP@HL, SP@ML	WMA9 Standard	1920x1080 / QCIF (176x144)	1920x1080@30fps / 1280x720@60fps

MKV (*.mkv)

Subtitle Type : Internal / External

Video Codec (Profile@Level)	Audio Codec	Max. / Min. Resolution	Max. Frame Rate
AVC / H.264 BP@L3, MP@L4.2, HP@L4.2	DTS core / AC3 / AAC-LC / E-AC3 / HE-AAC v1 / HE-AAC v2 / MPEG1L1 / MPEG1L2 / Vorbis	1920x1080 / QCIF (176x144)	1920x1080@60fps
MPEG4 SP@L6, ASP@L5, ACEP@L4	DTS core / AC3 / AAC-LC / E-AC3 / HE-AAC v1 / HE-AAC v2 / MPEG1L1 / MPEG1L2 / Vorbis	1920x1080 / QCIF (176x144)	1920x1080@30fps / 1280x720@60fps
VP8	DTS core / AC3 / AAC-LC / E-AC3 / HE-AAC v1 / HE-AAC v2 / MPEG1L1 / MPEG1L2 / Vorbis	1920x1080 / QCIF (176x144)	1920x1080@30fps / 1280x720@60fps

Video Codec (Profile@Level)	Audio Codec	Max. / Min. Resolution	Max. Frame Rate
VP9 Profile 0, Profile 2	DTS core / AC3 / AAC-LC / E-AC3 / HE-AAC v1 / HE-AAC v2 / MPEG1L1 / MPEG1L2 / Vorbis	3840x2160 / QCIF (176x144)	3840x2160@60fps
AVC / H.264 BP@L5.2, MP@L5.2, HP@L5.2	DTS core / AC3 / AAC-LC / E-AC3 / HE-AAC v1 / HE-AAC v2	3840x2160 / QCIF (176x144)	3840x2160@60p / 1920x1080@120fps
HEVC / H.265 MP@L5.1, Main10@L5.1	DTS core / AC3 / AAC-LC / E-AC3 / HE-AAC v1 / HE-AAC v2	3840x2160 / QCIF (176x144)	3840x2160@60p / 1920x1080@120fps
AVC BL@L6, HP@L6, HP10@L6	DTS core / AC3 / AAC-LC / E-AC3 / HE-AAC v1 / HE-AAC v2	3840x2160 / 3840x2160	3840x2160@60fps
HEVC / H.265 MP@L6, MP10@L6	DTS core / AC3 / AAC-LC / E-AC3 / HE-AAC v1 / HE-AAC v2	3840x2160 / 3840x2160	3840x2160@60fps

3gpp (*.3gp / *.3g2)

Subtitle Type : External

Video Codec (Profile@Level)	Audio Codec	Max. / Min. Resolution	Max. Frame Rate
MPEG4 SP@L6, ASP@L5, ACEP@L4	AAC-LC / HE-AAC v1 / HE-AAC v2 / AC3 / E-AC3 /	1920x1080 / QCIF (176x144)	1920x1080@30fps / 1280x720@60fps

Video Codec (Profile@Level)	Audio Codec	Max. / Min. Resolution	Max. Frame Rate
	MPEG1L1 / MPEG1L2		
AVC / H.264 BP@L3, MP@L4.2, HP@L4.2	AAC-LC / HE-AAC v1 / HE-AAC v2 / AC3 / E-AC3 / MPEG1L1 / MPEG1L2	1920x1080 / QCIF (176x144)	1920x1080@60fps

MOV (*.mov)

Subtitle Type : External

Video Codec (Profile@Level)	Audio Codec	Max. / Min. Resolution	Max. Frame Rate
AVC / H.264 BP@L3, MP@L4.2, HP@L4.2	AAC-LC / HE-AAC v1 / HE-AAC v2 / AC3 / E- AC3 / MPEG1L1 / MPEG1L2 / μ -LAW / PCM (U8) / PCM (S16BE) / PCM (S16LE)	1920x1080 / QCIF (176x144)	1920x1080@60fps
MPEG4 SP@L6, ASP@L5, ACEP@L4	AAC-LC / HE-AAC v1 / HE-AAC v2 / AC3 / E- AC3 / MPEG1L1 / MPEG1L2 / μ -LAW / PCM (U8) / PCM (S16BE) / PCM (S16LE)	1920x1080 / QCIF (176x144)	1920x1080@30fps / 1280x720@60fps
Motion JPEG	AAC-LC / HE-AAC v1 / HE-AAC v2 / AC3 / E- AC3 / MPEG1L1 / MPEG1L2 / μ -LAW / PCM (U8) / PCM (S16BE) / PCM (S16LE)	1280x720 / QCIF (176x144)	1280x720@30fps

WebM (*.webm)

Subtitle Type : External

Video Codec (Profile@Level)	Audio Codec	Max. / Min. Resolution	Max. Frame Rate
VP8	Vorbis	1920x1080 / QCIF (176x144)	1920x1080@30fps / 1280x720@60fps
VP9 Profile 0, Profile 2	Vorbis	3840x2160 / QCIF (176x144)	3840x2160@60fps

Other supported files and formats

- [Photos](#)
- [Music](#)
- [Audio sampling rates \(for videos\)](#)
- [External subtitles](#)

[73] Using the TV with Other Devices | Supported files and formats

Audio sampling rates (for videos)

Audio Codec	Sampling Rate
LPCM	44.1k / 48k
MPEG1L1 / MPEG1L2	32k / 44.1k / 48k
MPEG1L3	32k / 44.1k / 48k
AAC-LC	16k / 22.05k / 24k / 32k / 44.1k / 48k
HE-AAC v1 / v2	24k / 32k / 44.1k / 48k
AC3	32k / 44.1k / 48k
AC4	44.1k / 48k

Audio Codec	Sampling Rate
E-AC3	32k / 44.1k / 48k
Vorbis	8k / 11.025k / 16k / 22.05k / 32k / 44.1k / 48k
WMA9	8k / 11.025k / 16k / 22.05k / 32k / 44.1k / 48k
DTS core	44.1k / 48k
μ-LAW	8k
PCM (U8)	8k
PCM (S16LE)	11.025k / 16k / 44.1k
PCM (S16BE)	11.025k / 16k / 44.1k

Other supported files and formats

- [Photos](#)
- [Music](#)
- [Videos](#)
- [External subtitles](#)

[74] Using the TV with Other Devices | Supported files and formats

External subtitles

Use case : USB

File Format	Extension
SubStation Alpha	*.ass / *.ssa
SubRip	*.srt

Other supported files and formats

- [Photos](#)

- [Music](#)
 - [Videos](#)
 - [Audio sampling rates \(for videos\)](#)
-

[75] Using the TV with Other Devices

Available devices and settings

USB devices

[Playing content stored on a USB device](#)

[Information about USB devices used for storing photos and music](#)

TV box, Blu-ray and DVD players

[Connecting a TV box, Blu-ray or DVD player](#)

[Watching Blu-ray and DVD discs](#)

[How to control the TV box using the TV remote control](#)

Smartphones and tablets

[Displaying the iPhone/smartphone or iPad/tablet app screen on the TV](#)

[BRAVIA Connect App](#)

Computers, cameras, and camcorders

[Connecting a computer and viewing stored content](#)

[Connecting a camera or camcorder and viewing stored content](#)

Audio system (such as an AV receiver or sound bar)

[Outputting audio from an audio system](#)

[Connecting an audio system](#)

[Adjusting an audio system](#)

[Using the TV as a centre speaker](#)

[Audio formats](#)

[Accessing audio system settings](#)

Gaming device

[Video game consoles](#)

Neckband speaker or headphones

[Experiencing 3D surround with a neckband speaker or headphones](#)

Bluetooth devices

[Connecting a Bluetooth device \(such as Bluetooth headphones\)](#)

[Supported Bluetooth profiles](#)

AV sync settings

[Adjusting the AV sync setting](#)

BRAVIA Sync-compatible devices

[BRAVIA Sync overview](#)

[Using features available for BRAVIA Sync-compatible devices](#)

[Adjusting BRAVIA Sync settings](#)

Viewing pictures in 4K from compatible devices

[Viewing pictures in 4K resolution](#)

[Settings for viewing pictures through HDMI input with higher quality.](#)

TV connection with devices

[BRAVIA Connectivity Guide](#)

Supported files and formats

[Photos](#)

[Music](#)

[Videos](#)

[Audio sampling rates \(for videos\)](#)

[External subtitles](#)

[76] Connecting to a Network | Connecting to a network

Connecting to a network using a LAN cable

A wired LAN connection allows you to access the Internet and your home network. Make sure to connect to the Internet or home network via a router.

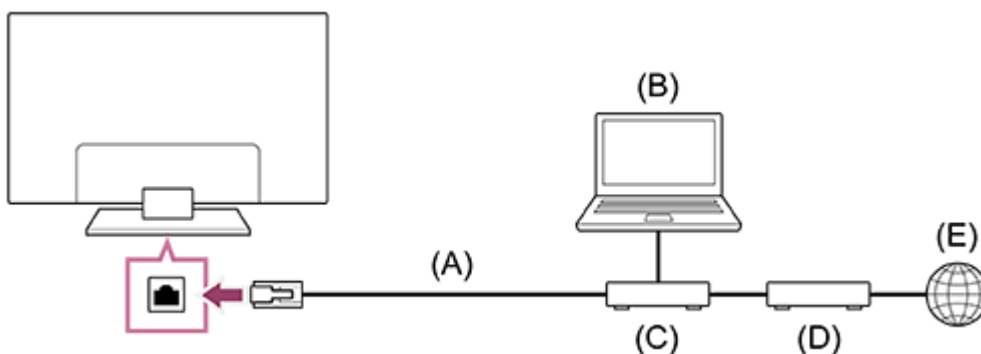

- (A) LAN cable
- (B) Computer
- (C) Router
- (D) Modem
- (E) Internet

1. Set up your LAN router.

For details, refer to the instruction manual of your LAN router, or contact the person who set up the network (network administrator).

Note

- It is strongly recommended for security purposes to connect your TV to the Internet via a router/modem that includes router functionality. Direct connection of your TV to the Internet may expose your TV to a security threat such as extraction or tampering of content or personal information. Contact your service provider or network administrator to confirm your network includes router functionality.
- The network-related settings that are required may vary depending on the Internet service provider or router. For details, refer to the instruction manuals provided by the Internet service provider or those supplied with the router. You can also contact the person who set up the network (network administrator).
- Depending on the operating environment of the network, connection speed may differ. The communication rate and quality are not guaranteed.

[77] Connecting to a Network | Connecting to a network

Connecting to a network using Wi-Fi

The built-in wireless LAN device allows you to access the Internet and enjoy the benefits of networking in a cable-free environment.

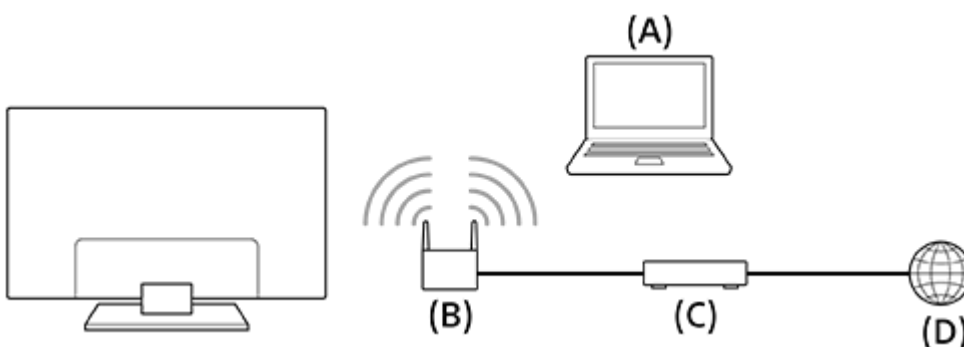

- (A) Computer
- (B) Wireless router
- (C) Modem
- (D) Internet

1. Set up your wireless router.

For details, refer to the instruction manual of your wireless router, or contact the person who set up the network (network administrator).

2. Press the  (Quick Settings) button on the remote control, then select [Settings] — [Network and Internet].

3. Select a network you want to connect to and set the password.

To turn off the built-in wireless LAN

1. To disable [Wi-Fi], press the  (Quick Settings) button on the remote control, then select [Settings] — [Network and Internet] — [Wi-Fi].

Hint

- For smooth video streaming:

Change the setting of your wireless router to a high-speed networking standard such as 802.11n, 802.11ac or 802.11ax if possible.

For details on how to change the setting, refer to the instruction manual of your wireless router, or contact the person who set up the network (network administrator).

If the above procedure does not deliver any improvement, change the setting of your wireless router to 5GHz, which may help improve the video streaming quality.

The 5GHz band may not be supported depending on your region/country. If the 5GHz band is not supported, the TV can only connect to a wireless router using the 2.4GHz band.

Note

- It is strongly recommended for security purposes to connect your TV to the Internet via a router/modem that includes router functionality. Direct connection of your TV to the Internet may expose your TV to a security threat such as extraction or tampering of content or personal information.
Contact your service provider or network administrator to confirm your network includes router functionality.
- The network-related settings that are required may vary depending on the Internet service provider or router. For details, refer to the instruction manuals

provided by the Internet service provider or those supplied with the router. You can also contact the person who set up the network (network administrator).

- If you select the [Show password] option in the password entry screen, the exposed password may be seen by other individuals.

[78] Connecting to a Network | Home network features

Adjusting home network settings

You can adjust the following home network settings.

To connect to a server

Connect the client device (TV) and the server device (BD/DVD recorder) to the same network.

To register the TV as a client device on the server, refer to the server device manual.

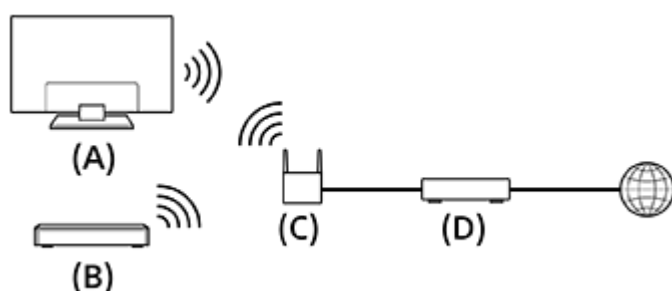

(A) TV

(B) BD/DVD recorder

(C) Wireless LAN router

(D) Modem

To check the server connection

Press the  (Quick Settings) button on the remote control, then select [Settings] — [Network and Internet] — [Home network setup] — [Server diagnostics] — follow the on-screen instructions to perform diagnostics.

To use the remote device

Press the  (Quick Settings) button on the remote control, then select [Settings] — [Network and Internet] — [Remote device settings] — the desired option.

[Control remotely]

Enable operation of the TV from a registered device.

[79] Connecting to a Network | Home network features

Playing content from a computer

You can enjoy content (photo/music/video files) stored on a network device located in another room, if you connect the TV to a home network via a router.

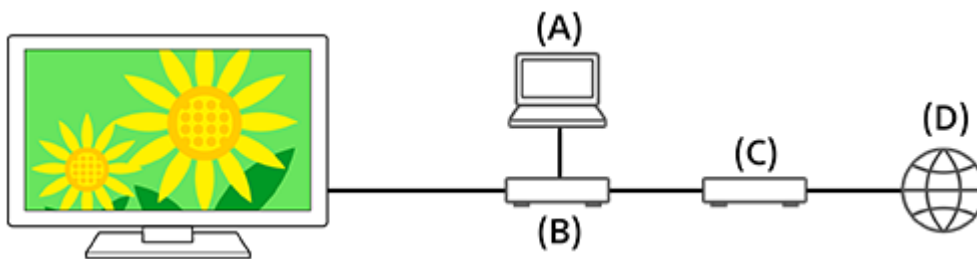

(A) Computer (Server)

(B) Router

(C) Modem

(D) Internet

1. Connect the TV to your home network.
2. Press the  (HOME) button, and select Apps from the Home menu, then select [Media Player].
3. Select the network device name.
4. Select the folder, and then select the file to play.

To check the supported file formats

- Photos
- Music
- Videos
- Audio sampling rates (for videos)
- External subtitles

Note

- Depending on the file, playback may not be possible even when using the supported formats.

[80] Settings

Using the Quick Settings

If you press the  (Quick Settings) button on the remote control, you can quickly access features such as [Picture & Sound], [Content type], [Picture mode], [Sleep timer], and [Picture Off] on the current screen, and settings such as [Speakers] depending on the connected devices. You can also display [Settings] from [Quick Settings].



Note

- The menus displayed in the TV settings vary depending on your model/region/country.







1. Press the  (Quick Settings) button on the remote control.
2. Move the focus to change a setting or select it.

To change the settings that are displayed

1. Press the  (Quick Settings) button on the remote control.
2. Move the focus left or right, and select  (Edit).
3. Select the desired setting.
4. Select [Close].

Hint

- To change the order or hide a displayed item, press and hold the  (Enter) button on the remote control with that item highlighted, and [Move] and [Hide] will be displayed. If you select [Move], use  (Left) /  (Right) on the remote

control to move the item to the desired position, and then press the  (Enter) button on the remote control.

- With [BRAVIA notifications] in Quick Settings, you can check if there are notifications such as software updates and low battery levels in the Voice Remote Control.

[81] Settings

Using the Eco Dashboard

You can configure various settings to reduce power consumption, such as Power saving.

You can also check descriptions for features while setting them.

Note

- The menus displayed in the TV settings vary depending on your model/region/country.
1. Press the  (Quick Settings) button on the remote control, and select [Eco Dashboard].



2. In the displayed menu, move the focus left or right and select the desired setting.



[82] Settings

Channels & Inputs

You can configure settings related to TV broadcasts and external devices connected to the TV, including [Channels], which allows you to configure the optimal channel settings for your area.

Note

- The menus displayed in the TV settings vary depending on your model/region/country.



1. Press the  (Quick Settings) button on the remote control, then select [Settings] — [Channels & Inputs] — the desired option.

Available options

[Channels]

Configures the settings related to receiving broadcast programming. You can also configure the settings related to receiving satellite broadcast programming.

- To tune digital channels
[Receiving digital broadcasts](#)
- To tune your satellite
[Receiving satellite broadcasts](#)
- To sort channels or edit the channel list
[Sorting or editing the channels](#)

[Channel preferences]

Configures [Subtitle settings] and [Audio settings (Broadcast)].

[External inputs]

Configures the settings of the external inputs and BRAVIA Sync.

For details about BRAVIA Sync, refer to [BRAVIA Sync overview](#).

[Recording device setup]

Configures the settings of USB HDD devices for recording. (This option may not be available depending on your model/region/country.)

For details on how to register your USB HDD device, refer to [Registering a USB HDD device](#).

[TV button shortcut]

If an external input such as a connected tuner is set, it will be displayed when the TV button on the remote control is pressed.

[83] Settings

Display & Sound

You can set the image and sound quality modes that are appropriate for the content you are watching, as well as detailed settings such as your preferred brightness and left-right balance of sound.

Note

- The menus displayed in the TV settings vary depending on your model/region/country.

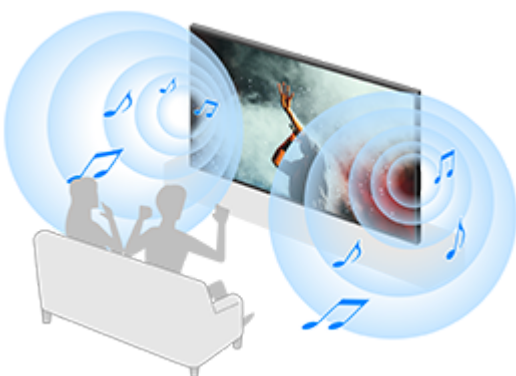

1. Press the  (Quick Settings) button on the remote control, then select [Settings] — [Display & Sound] — the desired option.

Available options

[Picture & Sound]

- **[Content type]**

Configures [Content type] based on the content.

Adjust the picture and sound based on the [Content type].

For information about [Content type], refer to the [Selecting the Content type based on the current content](#) page.

[Picture]

Configures display settings that adjust the picture quality, such as screen brightness.

To adjust the picture quality to your preferences, refer to the [Adjusting the picture quality](#) page.

[Sound (*)]**

Configures settings that adjust the sound.

To adjust the sound quality to your preferences, refer to the [Adjusting the sound quality](#) page.

[Audio output]

Configures selection settings related to speakers.

For details, refer to [Audio output] in [Adjusting the sound quality](#).

[Ambient Optimisation Pro]

Configures settings for [Auto adjust according to sensors] and [Auto adjust according to installation environment].

For details, refer to [Adjusting the picture/sound quality automatically](#).

[Expert panel settings] (only models equipped with an OLED panel)

Use when setting [Pixel shift] or manually performing [Panel refresh].

Hint

- To mute the remote control operation sound, refer to [Voice Remote Control](#).

[84] Settings

Network and Internet

Configures settings for such things as wireless LANs, wired LANs, and home networks.

For details about connecting to the Internet, refer to [Connecting to a network using a LAN cable](#) or [Connecting to a network using Wi-Fi](#).

Note

- The menus displayed in the TV settings vary depending on your model/region/country.
-

[85] Settings

Accounts and sign-in

Note

- The menus displayed in the TV settings vary depending on your model/region/country.
1. Press the  (Quick Settings) button on the remote control, then select [Settings] — [Accounts and sign-in] — the desired option.

Available options

When a Google Account is set on the TV

Configure the Google Account or add other accounts.

When a Google Account is not set on the TV

[Accounts and sign-in] cannot be used. To set a Google Account, set up Google TV from the settings menu.

[86] Settings

Privacy

Configure the security of device, account and app settings.

Note

- The menus displayed in the TV settings vary depending on your model/region/country.

[87] Settings

Apps

Allows you to configure or uninstall apps, or clear the cache.

Note

- The menus displayed in the TV settings vary depending on your model/region/country.

[88] Settings

System

1. Press the  (Quick Settings) button on the remote control, then select [Settings] — [System] — the desired option.

Note

- The menus displayed in the TV settings vary depending on your model, region, or country, and some options may not be displayed or available based on the TV's settings.

Available options

[Accessibility]

Configures the settings of accessibility features and services for helping users navigate their devices more easily.

For details, refer to [Accessibility features](#).

[About]

Displays information about the TV.

Here, you can reset your TV.

[Date and time]

Configures the current time and auto clock display.

[Language]

Selects the menu language. The selected menu language will also set the voice recognition language.

[Keyboard]

Configures the settings of the on-screen keyboard.

[Storage]

Changes the settings related to data storage.

[Ambient mode]

Configures what is displayed on the screen when the TV is not operated after a certain amount of time while displaying content other than broadcasts and videos.

[Power and energy]

Configures the settings related to saving energy and the startup TV screen.

[Cast]

Configures the operation permissions when casting from an external device.

For details, refer to [Displaying the iPhone/smartphone or iPad/tablet app screen on the TV](#).

[System sounds]

Configures the system sounds.

[Parental controls]

Configures the parental lock settings for restricting usage of items such as [Channels], [Apps] and [Screen time].

[Gesture Control]

Configures the gesture operations used when facing the camera.

For details, refer to [Using the Camera and Microphone Unit](#).

[Built-in MIC sensitivity]

Sets the sensitivity of the built-in MIC.

To use the built-in MIC, you may need to update the TV's software.

For details, refer to [Using the built-in MIC on the TV \(only TVs with a built-in MIC\)](#).

[LED indicator]

Configures the [Operational response] and [Voice detection status]^{*} settings. (The displayed menu varies depending on the model.)

For details, refer to [How the LEDs light up](#).

[Apple AirPlay & HomeKit]

Configures the settings for Apple AirPlay & HomeKit.

[Initial setup]

Sets up the basic features such as network and channels for first time use.

[Retail mode settings]

Enriches the display for shop front use by setting [Demo mode], etc.

[Restart]

Restarts the TV.

For details, refer to [Reset \(restart\) your TV](#).

^{*} Only TVs with a built-in MIC

[89] Settings

Remotes and accessories

You can pair Bluetooth devices, including the supplied Voice Remote Control, and enable/disable Bluetooth.

Note

- The menus displayed in the TV settings vary depending on your model/region/country.

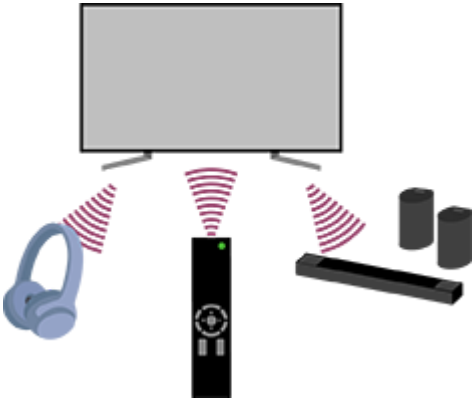

1. Press the  (Quick Settings) button on the remote control, then select [Settings] — [Remotes and accessories] — the desired option.

Available options

You can enable or disable Bluetooth, or register Bluetooth devices.

[Bluetooth]

Enables or disables Bluetooth.

[Pair accessory]

Pairs Bluetooth devices.

For details, refer to [Connecting a Bluetooth device \(such as Bluetooth headphones\)](#).

[3D surround device settings]

You can enjoy the immersive sound of 3D surround (stereophonic sound).

For details, visit the following URL.

<https://www.sony.net/bravia-xr-3ds2>



<https://www.sony.net/bravia-xr-3ds2>

[BRAVIA Cam]

Connects the Camera and Microphone Unit to set up Camera sensing functions.

For details, refer to [Using the Camera and Microphone Unit](#).

[Remote control]

Setup for pairing the Voice Remote Control. Follow the on-screen instructions.

Hint

- To mute the remote control operation sound, refer to [Voice Remote Control](#).
-

[90] Settings

Help and feedback

Help from Sony can be displayed here. If a Google Account is set on the TV, you can also give Google feedback.

[91] Settings



Timers & Clock

In Timers & Clock, you can set the On timer, Sleep timer, Alarm, and Clock display.

Note

- The menus displayed in the TV settings vary depending on your model/region/country.

Adding Timers & Clock to the input selection screen

1. Press the  (Input select) button.
Available devices and apps are displayed at the bottom of the screen.
2. Press the  (Right) button on the remote control and select  (Edit).
3. Select Timers & Clock and press the Enter button.
Timers & Clock is added.

To configure settings for Timers & Clock

1. Press the  (Input select) button on the remote control and select the following.
[Timers & Clock] — the desired setting

Available options

[On timer]

Turns on the TV to the desired channel or input at a preset time.

[Sleep timer]

Turns off the TV after a preset time.

[Alarm]

Plays a sound after a preset time.

[Clock display]

Displays the clock on the TV screen always or at every hour.

[92] Settings

Available Settings

[Using the Quick Settings](#)

[Using the Eco Dashboard](#)

[Channels & Inputs](#)

[Display & Sound](#)

[Network and Internet](#)

[Accounts and sign-in](#)

[Privacy](#)

[Apps](#)

[System](#)

[Remotes and accessories](#)

[Help and feedback](#)

[Timers & Clock](#)

Reset (restart) your TV

If you have trouble such as the picture not displaying on the screen or the remote control not working, reset the TV with the following procedure. If the problem persists, try the factory reset procedure below.

If an external USB device is connected to the TV, disconnect the USB device from the TV before resetting.

Power Reset

1. Restart the TV with the remote control.

Press and continue holding the Power button on the remote control for about 5 seconds until the TV restarts (a shutting down message will appear).

2. Unplug the AC power cord (mains lead).

If the problem persists after step 1, unplug the TV power cord (mains lead) from the electrical outlet. Then press the Power button on the TV once, and release it. Wait for 2 minutes, and plug the power cord (mains lead) back into the electrical outlet. Depending on the model, you can press and hold the Power button on the TV (40 seconds or longer) until it turns off and restarts.

Hint

- TV models with 1 button on the TV (Power button only) can also be restarted using the Power button. Press the Power button on the TV to display the operation menu, select [Restart] in the menu, and then press and hold the Power button to restart the TV.
- Your personal settings and data will not be lost after the TV restarts.

Factory data reset



If the problem persists after a power reset, try a factory data reset.

For details, refer to [Factory data reset](#).

Software updates

Sony will provide software updates from time to time in order to enhance functionality and provide users with the latest TV experience. The easiest way to receive software updates is via an internet connection to the TV.

To check for software updates automatically

1. Press  (Input select) on the remote control and select [Help]. If [Help] does not exist, select  [Edit] and add [Help].
2. Select [Status & Diagnostics] — [System software update] — enable [Automatically check for update].

Hint

- To update the software manually, select [Software update].
- You can check the BRAVIA notifications or support website for a list of changes made by the software update.

Note

- When [Automatically check for update] is disabled, the TV cannot receive notifications even when a software update is available.

Updating software via USB storage device



If you do not have a network connection, you can also update the software by using a USB storage device.

For more about the support site, please see the [Support Site](#) page.

[95] Troubleshooting

Self diagnostics

Check if the TV is working properly.

1. Press  (Input select) on the remote control and select [Help]. If [Help] does not exist, select  [Edit] and add [Help].
2. Select [Status & Diagnostics] — [Self diagnostics].

Hint

You can also check the following symptoms in [Status & Diagnostics].

- [Internet connection diagnostics]

- [External device connection diagnostics]
- [Picture/Sound test]

If the problem persists, try the following.

- Reset (restart) the TV. For details, refer to [Reset \(restart\)_your TV](#).
- Check and try [Software updates](#).
- [Support Site](#)

[96] Troubleshooting

Frequently Asked Questions for Troubleshooting

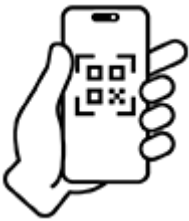

For troubleshooting information, you can also refer to “Frequently Asked Questions” in our support site below.

<https://www.sony.net/androidtv-faq/>



<https://www.sony.net/androidtv-faq/>

[97] Others

About the Help Guide

This Help Guide explains how to use this TV. You can also refer to the Setup Guide for descriptions about TV installation, and the Reference Guide for information such as specifications, and wall mounting of this TV.

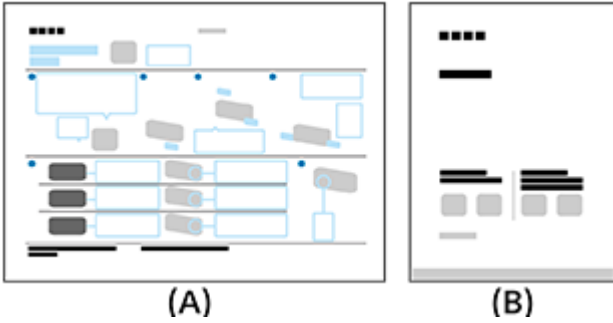

- (A) Setup Guide
- (B) Reference Guide

Help Guide versions

There are two versions of the Help Guide: the built-in version and the online version. The online Help Guide includes the latest information.

The online Help Guide is automatically displayed when the TV is connected to the internet, otherwise the built-in Help Guide is displayed.



Note

- To use the latest features described in the Help Guide, you may need to update the TV's software. For details about software updates, see the [Software updates](#) page.
- The names of settings in the Help Guide may differ from those displayed on the TV depending on the TV's release date or your model/country/region.
- The images and illustrations used in the Help Guide may differ depending on your TV model.
- Design and specifications are subject to change without notice.
- The Help Guide contains descriptions common across all models/regions/countries. Some descriptions of features do not apply depending on your model/region/country.

Hint

- This Help Guide is written for all regions/countries. Some descriptions contained in this Help Guide do not apply to some regions and countries.

Specifications

You can find the specification information on the Sony support website:
Please visit the product page of your TV and refer to Specifications. For more about the support website, see the [Support Site](#) page.



Note

- A Specifications page may not be available depending on your model. In such cases, please refer to the Reference Guide.

[99] Others

Support Site

For the latest information and Online Help Guide, please visit the Sony support website:

<https://www.sony.eu/support/>



<https://www.sony.eu/support/>

[100] Others

Keeping the TV updated

The TV acquires data such as programme guides while it is in standby/networked standby mode. To keep your TV updated, we recommend that you turn off the TV normally by using the Power button on the remote control or TV.

[101] Others

Factory data reset

You can perform the Factory data reset. If an external USB device is connected to the TV, disconnect the USB device from the TV before resetting.

Note

Performing a factory reset will delete all of the TV's data and settings (such as Wi-Fi and wired network setting information, Google Account and other login information, and installed apps).

1. Press the  (Quick Settings) button on the remote control, then select [Settings] — [System] — [About] — [Reset] — [Factory data reset].

2. Select [Erase everything].

If you have set a PIN code on your TV, you will be prompted to input it.

After the factory reset process completes successfully, the TV will start the Initial Setup wizard. You must agree to the Google Terms of Service and Google Privacy Policy.

[102] Others

Trademark information



- © Xperi Inc. All Rights Reserved. Vewd, TiVo and the Vewd and TiVo logos are trademarks or registered trademarks of Xperi Inc. or its subsidiaries in the United States and other countries.



NetFront™ Browser BE

- This product contains NetFront Browser of ACCESS CO., LTD.
- ACCESS, the ACCESS logo and NetFront are trademarks or registered trademarks of ACCESS CO., LTD. in the United States, Japan and other countries.
- © 2023 ACCESS CO., LTD. All rights reserved.
- This software is based in part on the work of the Independent JPEG Group.



- The Bluetooth® word mark and logos are registered trademarks owned by Bluetooth SIG, Inc. and any use of such marks by Sony Group Corporation and its subsidiaries is under license.



- Manufactured under license from IMAX Corporation. IMAX[®] is a registered trademark of IMAX Corporation in the United States and/or other countries. For DTS patents, see <https://xperi.com/dts-patents/>. Manufactured under license from DTS, Inc. and its affiliates. DTS, DTS:X, the DTS:X logo, Virtual:X, and the DTS Virtual:X logo are registered trademarks or trademarks of DTS, Inc. and its affiliates in the United States and/or other countries. © DTS, Inc. and its affiliates. ALL RIGHTS RESERVED.



- Covered by one or more claims of the HEVC patents listed at patentlist.accessadvance.com.
- Wi-Fi[®], Wi-Fi Alliance[®], Wi-Fi CERTIFIED[™] and Wi-Fi CERTIFIED 6[®] are registered trademarks or trademarks of Wi-Fi Alliance.
- Wi-Fi CERTIFIED[™] logo and Wi-Fi CERTIFIED 6[®] logo are registered trademarks of Wi-Fi Alliance.
- Disney+ and all related logos and marks are trademarks of Disney Enterprises, Inc. or its affiliates.
- ©2025 Amazon.com, Inc. or its affiliates. Amazon, Alexa, Prime Video and all related logos are trademarks of Amazon.com (<http://amazon.com/>), Inc. or its affiliates. Amazon Prime membership and/or Prime Video fees apply. See [primevideo.com \(http://primevideo.com/terms\)](http://primevideo.com/terms) for details.
- Apple, Apple Home, AirPlay and HomeKit are trademarks of Apple Inc., registered in the U.S. and other countries and regions. To use AirPlay and Apple HomeKit with this TV, the latest version of iOS, iPadOS, or macOS is recommended.
- Google TV is the name of this device's software experience and a trademark of Google LLC. Google, YouTube, Google Cast, Google Play, and other marks are

trademarks of Google LLC.

- BRAVIA and **BRAVIA** logo are trademarks or registered marks of Sony Group Corporation or its affiliates.
- All other trademarks are the property of their respective owners.

Note

- The availability of each service depends on your region/country.